



Optical Encoders

SERIES 62A, V, D 1/2" Package

FEATURES

- Low Cost
- Long Life
- Available in 3.3 or 5.0 Vdc Operating Voltages
- High Torque Version to Emphasize Rotational Feel
- Economical Size
- Optically Coupled for More than a Million Cycles
- Optional Integral Pushbutton
- Compatible with CMOS, TTL and HCMOS Logic Levels
- Available in 12, 16, 20, 24 and 32 Detent Positions (Non-detent also available)
- Choice of Cable Lengths and Terminations

APPLICATIONS

- Global Positioning/Driver Information Systems

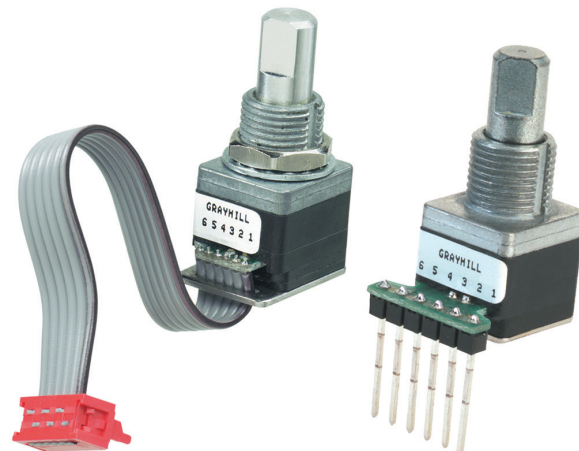

DIMENSIONS in inches (and millimeters)

Cable Version

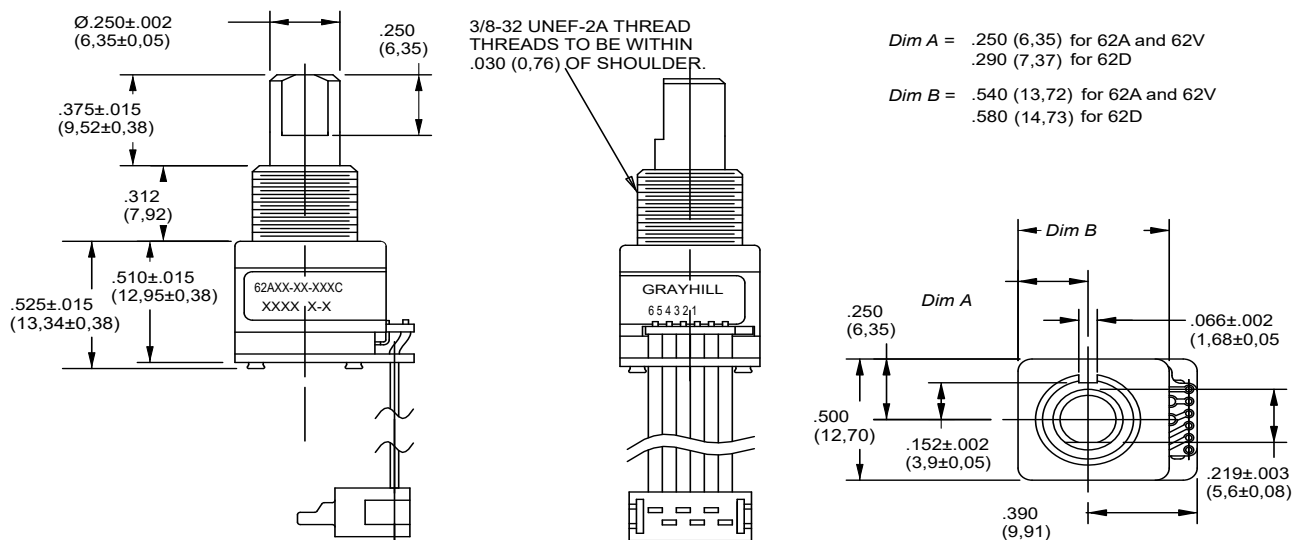

Pin Version

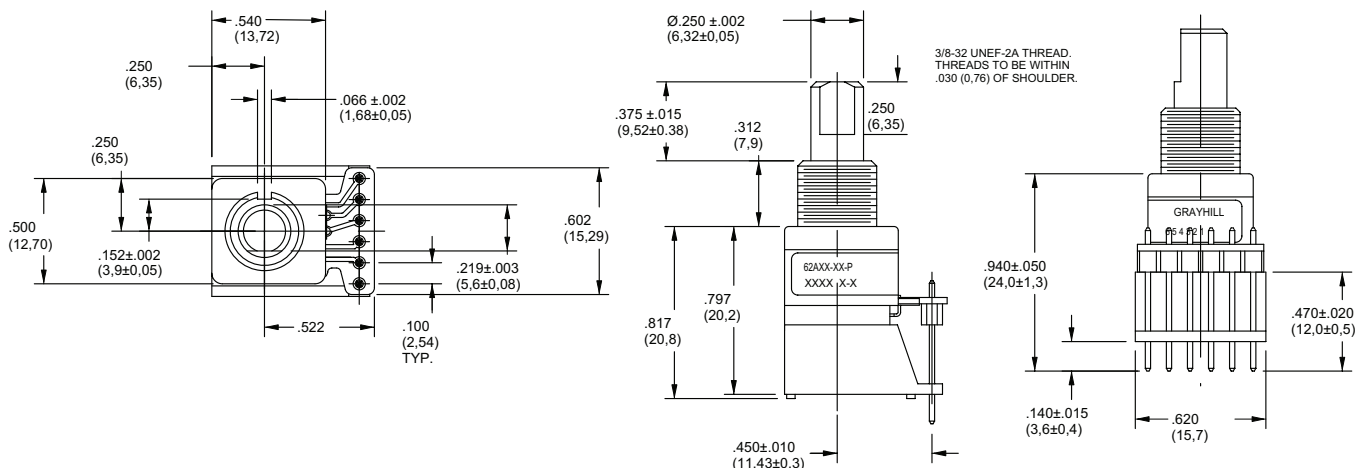

TERMINATION OPTIONS

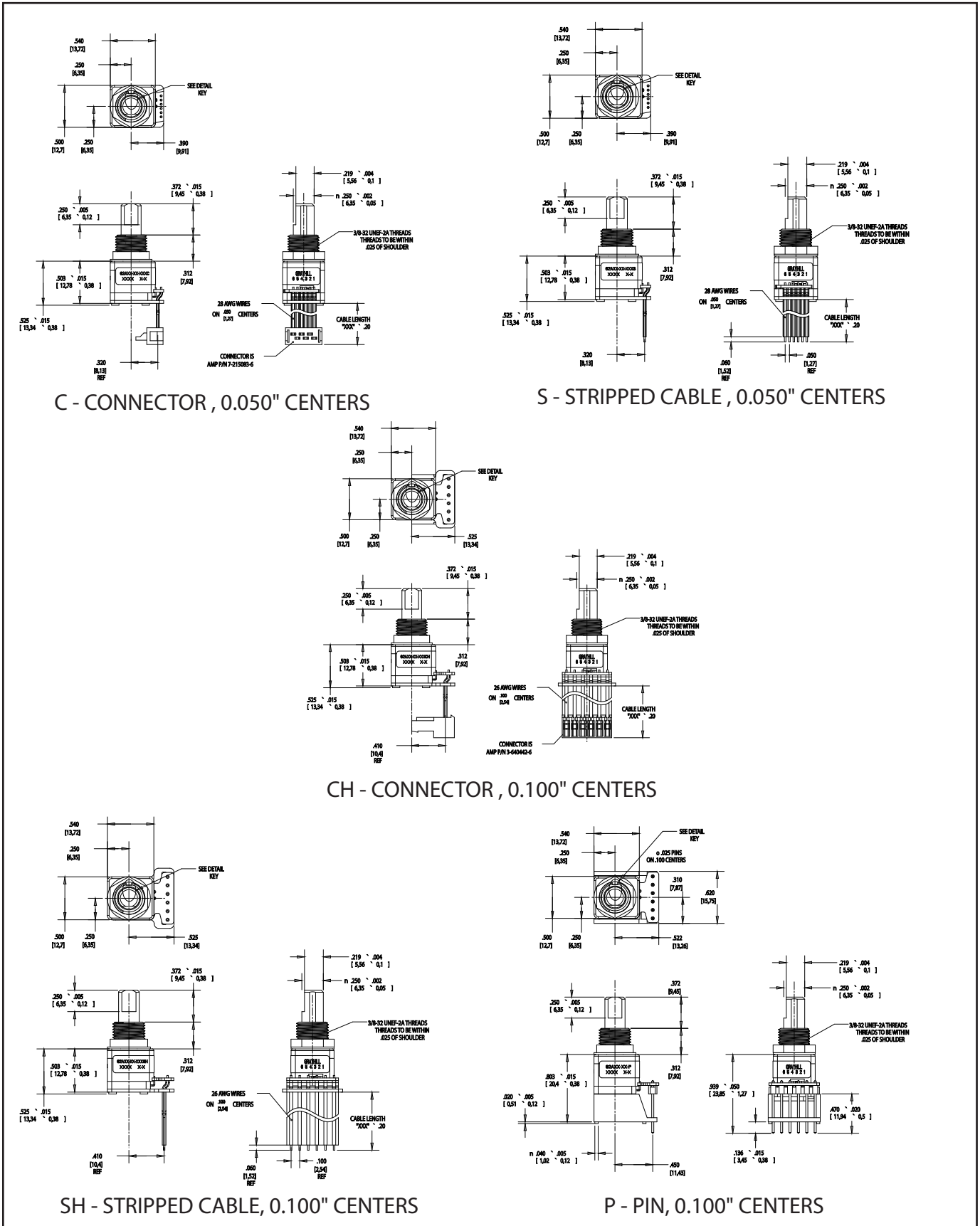

Optical and Mechanical Encoders

SUPPLY CURRENT & LOGIC OUTPUT CHARACTERISTICS

		A & D STYLE	V STYLE
OPERATING VOLTAGE:		5.00±.25 Vdc.	3.30±.125 Vdc.
SUPPLY CURRENT:		30 mA MAXIMUM.	50 mA MAXIMUM.
LOGIC OUTPUT CHARACTERISTICS:	SMT OPTICS	PUSH-PULL OUTPUTS COMPATIBLE WITH CMOS, TTL AND HCMOS LOGIC.	
		LOGIC HIGH: $V_{OH} = 4.5 \text{ Vdc MIN AT } I_{OH} = -8.0 \text{ mA \& } V_{CC} = 5.00 \text{ Vdc.}$	N/A
		LOGIC LOW: $V_{OL} = 0.5 \text{ Vdc MAX AT } I_{OL} = 8.0 \text{ mA.}$	N/A
	WIREBOND OPTICS	OPEN COLLECTOR PHOTOTRANSISTOR OUTPUT.	
		LOGIC HIGH: $V_{OH} = 3.8 \text{ Vdc MIN at } V_{CC} = 5.00 \text{ Vdc WITH } 2.2\text{k}\Omega \text{ PULL-UP RESISTOR.}$	LOGIC HIGH: $V_{OH} = 2.3 \text{ Vdc MIN at } V_{CC} = 3.30 \text{ Vdc WITH } 2.2\text{k}\Omega \text{ PULL-UP RESISTOR.}$
		LOGIC LOW: $V_{OL} = 0.8 \text{ Vdc MAX AT } I_{OL} = 2.0 \text{ mA WITH } 2.2\text{k}\Omega \text{ PULL-UP RESISTOR.}$	LOGIC LOW: $V_{OL} = 0.8 \text{ Vdc MAX AT } I_{OL} = 1.0 \text{ mA WITH } 2.2\text{k}\Omega \text{ PULL-UP RESISTOR.}$

WAVEFORM AND TRUTH TABLE Standard Quadrature 2-Bit Code

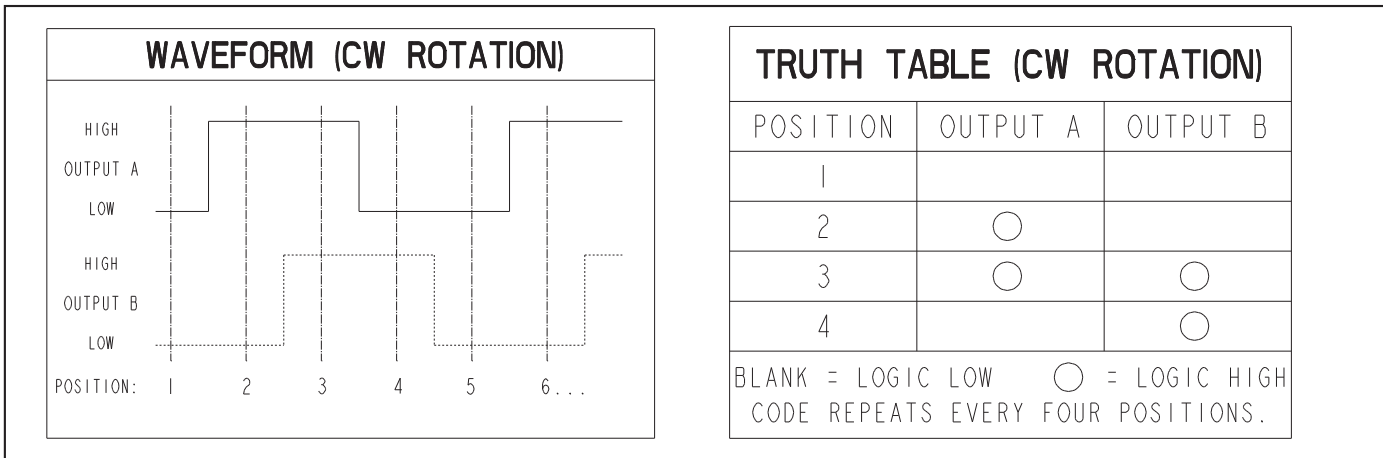

CIRCUITRY: SURFACE MOUNT OPTICS Pushpull Outputs (62A22, 62A15, 62A11)

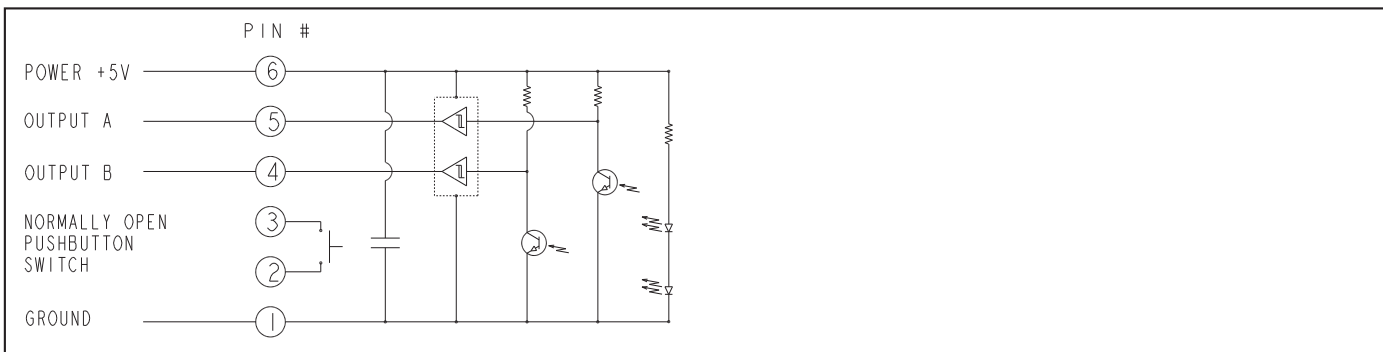

CIRCUITRY: WIREBOND OPTICS Open Collector Outputs (All Others)



Optical and Mechanical Encoders



Optical Encoders

SPECIFICATIONS

Electrical and Mechanical Ratings

Pushbutton Rating: 5 Vdc, 10 mA, resistive
Pushbutton Contact Resistance: less than 10 ohms (TTL or CMOS compatible)

Pushbutton Life: 3 million actuations min.

Pushbutton Contact Bounce: less than 4 mS at make and less than 10 mS at break

Pushbutton Actuation Force: 1000 ±300 grams

Pushbutton Travel: .010/.025 inch

Coding: 2-bit quadrature coded output

Voltage Breakdown: 250 Vac between mutually insulated parts

Rotational Life: 1,000,000 cycles minimum (One cycle is a rotation through all positions and a full return)

Optical Rise and Fall Times: less than 30 mS maximum

Operating Torque:

Style A and V: 2.0 ±1.4 in-oz. initially

Style D: 3.5 ±1.4 in-oz initially

Non-detent: less than 1.5 in-oz initially

Shaft Push Out Force: 45 lbs minimum

Mounting Torque: 15 in-lbs maximum

Terminal Strength: 15 lbs cable pull-out force minimum

Operating Speed: 100 RPM maximum

Axial Shaft Play: .010 maximum

Environmental Ratings

Operating Temperature Range: -40°C to 85°C

Storage Temperature Range:

-55°C to 100°C

Relative Humidity: 90–95% at 40°C for 96 hours

Vibration Resistance: Harmonic motion with amplitude of 15G, within a varied 10 to 2000 Hz frequency for 12 hours per MIL-STD-202, Method 204

Mechanical Shock: Test 1: 100G for 6 mS, half sine, 12.3 ft/s; Test 2: 100G for 6 mS, sawtooth, 9.7 ft/s

Materials and Finishes

Code Housing: Reinforced thermoplastic

Shaft: Zinc or aluminum

Bushing: Zinc casting

Shaft Retaining Ring: Stainless steel

Detent Spring: Stainless steel

Printed Circuit Boards: NEMA grade FR-4 gold over nickel or palladium

Terminals: Brass, tin-plated

Mounting Hardware: One brass, nickel-plated nut and zinc-plated spring steel with clear trivalent chromate finish lockwasher supplied with each switch. Nut is 0.094 inches thick by

0.435 inches across flats.

Rotor: Thermoplastic

Code Housing: Thermoplastic

Pushbutton Dome: Stainless steel

Dome Retaining Disk: Thermoplastic

Pushbutton Housing: Thermoplastic

Phototransistor: Planar Silicon NPN

Infrared Emitter: Gallium aluminum arsenide

Pushbutton Contact: Brass, nickel-plated

Flex Cable: 28AWG, stranded/top coated wire, PVC coated on .050 or .100" centers (cabled version)

Header Pins: Phosphor bronze, tin-plated

Spacer: ABS

Backplate/Strain Relief: Stainless steel

Suggested Mounting Panel Cutout

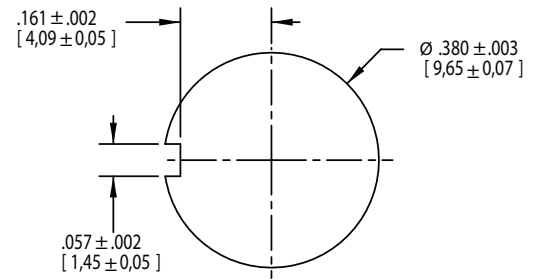

ORDERING INFORMATION

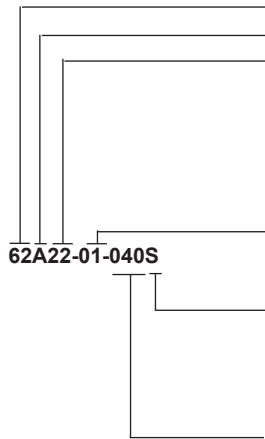

Series

Style: A = 1/2" package, 5.0 Vdc Input, D = high torque w/5.0 Vdc input, V = 3.3 Vdc input

Angle of Throw:

Detent

11 = 11.25° or 32 positions

15 = 15° or 24 positions

18 = 18° or 20 positions

22 = 22.5° or 16 positions

30 = 30° or 12 positions

Non-detent (Styles A&V only)

01 = 11.25° or 32 positions

05 = 15° or 24 positions

08 = 18° or 20 positions

02 = 22.5° or 16 positions

03 = 30° or 12 positions

Pushbutton Option: 01 = w/o pushbutton, 02 = with pushbutton

Termination:

S = Stripped cable; .050" centers

SH = Stripped cable; .100" centers

C = Connector; .050" centers

CH = Connector; .100" centers

P = Pin; .100" centers

Cable Length: Cable Termination: 040 = 4.0in. Cable is terminated with Amp P/N 215083-6. See Amp Mateability Guide for Mating Connector details.

*Eliminate cable length if ordering pins. (Ex: 62A22-02-P).

These switches have Quadrature 2-bit code output and an optional shaft actuated pushbutton switch.

Custom materials, styles, colors, and markings are available. Control knobs available.

Available from your local Grayhill Component Distributor.

For prices and discounts, contact a local Sales Office, an authorized local Distributor, or Grayhill.



Optical Encoder Engineering Information

QUADRATURE

All Grayhill encoders use quadrature output code, which is the same as a 2-bit, repeating gray code. Quadrature is the most popular and cost effective output format because only two detectors are required. However, quadrature can only be used in applications where incremental data is required. Absolute positioning is not possible because the code repeats every four positions. In other words, changes in the encoder in magnitude and direction can be determined, but the actual position of the encoder cannot. In most applications this is not a problem.

In a quadrature rotary optical encoder two detectors are used to provide outputs, "A" and "B". The code rotor either blocks the infrared light or allows it to pass to the detectors. As the shaft turns the rotor, the outputs change state to indicate position. The resulting output is two square waves which are 90° out of phase.

OPEN COLLECTOR OUTPUT

The open collector output is typical of the Series 61B, 61C and 62, and is the simplest form of output available. The first step in interfacing with open collector outputs is to provide an external pull-up resistor from each output to the power source. These pull-up

resistors provide the output with the high-state voltage when the phototransistor is "off".

In a phototransistor, base current is supplied when light strikes the detector, which effectively grounds the output. Typically, the detector is operated in saturation. This means sufficient light is provided to completely sink, or ground, all the current provided by the pull up resistor plus that of the interfacing electronics. In the logic high state, the light is sufficiently blocked by the rotor and the detector functions like an open circuit. The pull up resistor then provides sourcing current to the interfacing electronics. This "on" or "off" digital arrangement allows the open collector to interface with popular integrated circuit technologies such as TTL, TTL LS, CMOS, and HCMOS.

SCHMITT TRIGGERS

To provide signal enhancement it is recommended that a Schmitt Trigger be connected to each output. This device is already included in the Series 61K, 61R, 63K and 63R encoders. The Schmitt Trigger "cleans up" the output into a pure digital signal. It does this by removing the small linear region between the "on" and "off" states of the detector. During this transition the light is only partially blocked and the output is somewhere between what the interfacing circuit might con-

sider to be "on" or "off". In other words, the output is not completely digital. The Schmitt Trigger contains a very important feature which makes it attractive for this application. The device has a higher threshold, or trigger level, when it is in the "on" state than it does in the "off" state. This hysteresis filters any electrical noise, which can cause the output to change state rapidly during the transition. And since the output from the Schmitt Trigger is a pure digital signal and is isolated from the phototransistor, the signal is basically immune to loading problems that can effect encoders without the Schmitt Trigger. Schmitt Triggers are available in most popular IC technologies.

SHAFT AND PANEL SEAL

A shaft and panel seal are available to provide water-tight mounting for the Series 61B, 61D, 61K, 61R and 62 encoders. Sealing is accomplished by an o-ring shaft seal and a panel seal washer. The panel seal washer in the 61B and 61D encoders does not affect the overall dimensions of the switches. In the 61K and 61R encoders, the .045" thick washer is placed over the threads and sits flat on the base of the bushing. The 61KS and 61RS are also epoxy-sealed on the bottom of the switch to provide a completely sealed switch.

