

4 and 5 line ESD protection in SOT666

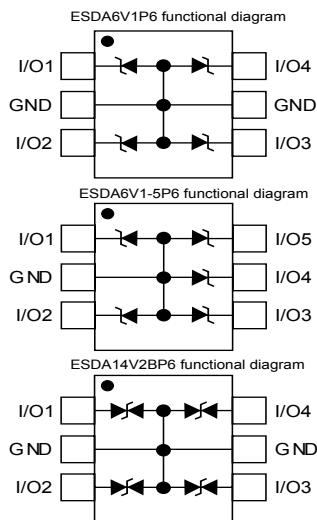
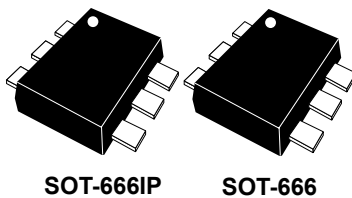

Product status link

[ESDAxxxP6](#)

Features

- 4 / 5 unidirectional (ESDA6V1P6 and ESDA6V1-5P6) and bidirectional (ESDA14V2BP6 and ESDA25-4BP6) Transil functions
- Breakdown voltage:
 - $V_{BR} = 6.1 \text{ V min.}, 14.2 \text{ V min. and } 25 \text{ V min.}$
- Low leakage current:
 - $< 500 \text{ nA}$ (ESDA6V1P6 / ESDA6V1-5P6)
 - $< 1 \mu\text{A}$ (ESDA14V2BP6 and ESDA25-4BP6)
- Very small PCB area $< 2.6 \text{ mm}^2$
- Benefits:
 - High ESD protection level
 - High integration
 - Suitable for high density boards
- Complies with the standard IEC 61000-4-2 level 4:
 - 15 kV (air discharge)
 - 8 kV (contact discharge)
- Complies with MIL STD 883E - method 3015-7: Class3
 - 25 kV (human body model)

Applications

Where ESD and EOS transient overvoltage protection in susceptible equipment is required, such as:

- Computers
- Servers
- Printers
- Communication systems and cellular phones
- Video equipment

These devices are particularly adapted to the protection of symmetrical signals.

Description

The ESDAxxxP6 are monolithic arrays designed to protect up to 5 lines against ESD transients.

These devices are ideal where board space saving and reduced line capacitance are required.

1 Characteristics

Table 1. Absolute ratings ($T_{amb} = 25\text{ °C}$)

Symbol	Parameter	Value	Unit	
V_{PP}	Peak pulse voltage	IEC 61000-4-2 level 4 standard:		
		Contact discharge	± 15	
		Air discharge	± 8	
		IEC 61000-4-2 level 4 standard for ESDA6V1-5P6:		
	Contact discharge	± 20	kV	
	Air discharge	± 25		
P_{PP}	Peak pulse power dissipation (8/20 μs) ⁽¹⁾ , T_j initial = T_{amb}	ESDA6V1P6 / ESDA6V1-5P6	150	W
		ESDA14V2BP6 / ESDA25-4BP6	50	
T_{stg}	Storage temperature range	-55 to +150	$^{\circ}\text{C}$	
T_j	Operating junction temperature range	-40 to +150	$^{\circ}\text{C}$	
T_L	Maximum lead temperature for soldering during 10 s at 5 mm for case	260	$^{\circ}\text{C}$	

1. for a surge greater than the maximum values, the diode will fail in short-circuit.

Figure 1. Electrical characteristics (definitions)

Symbol	Parameter
V_{BR}	Breakdown voltage
I_{RM}	Leakage current @ V_{RM}
V_{RM}	Stand-off voltage
V_{CL}	Clamping voltage
I_{PP}	Peak pulse current
I_F	Forward current
V_F	Forward voltage
R_d	Dynamic impedance
C_{LINE}	Line capacitance

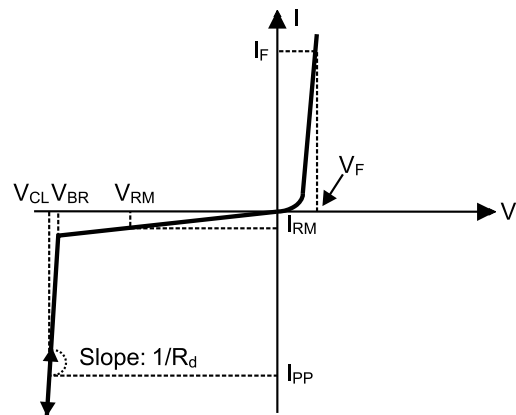
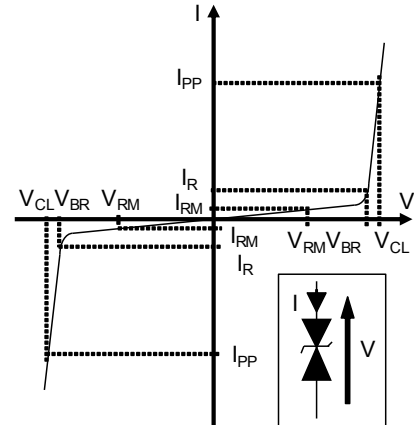

Figure 2. Electrical characteristics (definitions)

Symbol	Parameter
V_{BR}	= Breakdown voltage
V_{CL}	= Clamping voltage
I_{RM}	= Leakage current @ V_{RM}
V_{RM}	= Stand-off voltage
I_{PP}	= Peak pulse current
R_D	= Dynamic resistance
I_R	= Breakdown current

Table 2. Electrical characteristics - values ($T_{amb} = 25\text{ }^{\circ}\text{C}$)

Order code	V_{BR} at I_R		I_{RM} at V_{RM}		R_d	αT	C_{line}	
	Min.	Max.	Max.		Max.	Typ.	Typ. at 0 V	
	V	V	mA	μA	V	$10^{-4}/\text{C}$	pF	
ESDA6V1P6	6.1	7.2	1	0.5	3	1.5	4	70
ESDA6V1-5P6				0.1				
ESDA14V2BP6	14.2	18	1	1	12	1.5	5.8	25
				0.1				
ESDA25-4BP6	25	30	1	1	24	1.7	7.3	22

1.1 Characteristics (curves)

Figure 3. Peak power dissipation versus initial junction temperature

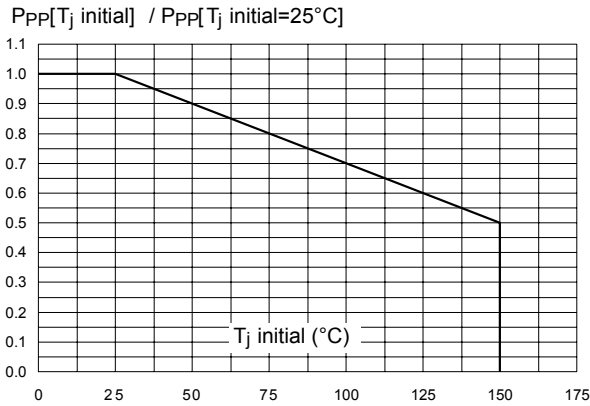

Figure 4. Peak pulse power versus exponential pulse duration (T_j initial = 25° C)

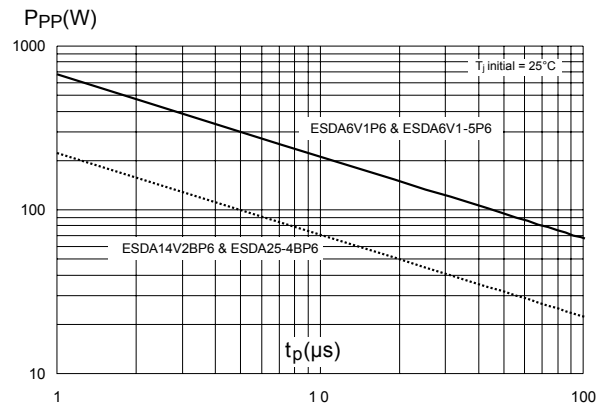

Figure 5. Clamping voltage versus peak pulse current (T_j initial = 25° C, rectangular waveform, $t_p = 2.5 \mu s$)

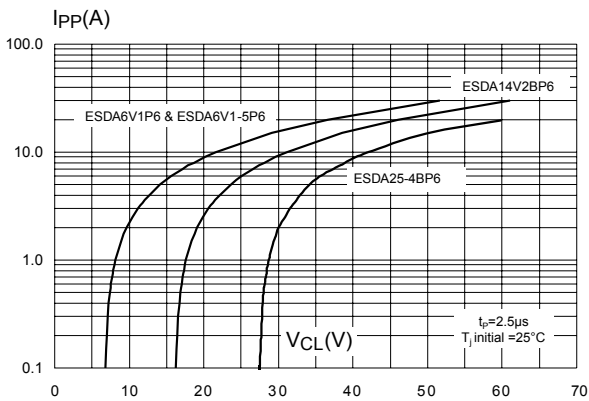

Figure 6. Junction capacitance versus reverse applied voltage (typical values)

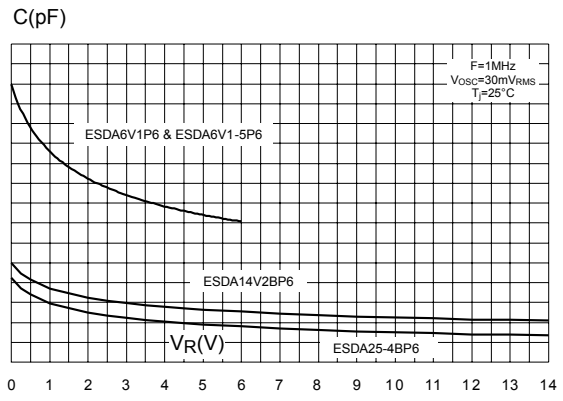

Figure 7. Relative variation of leakage current versus junction temperature (typical values)

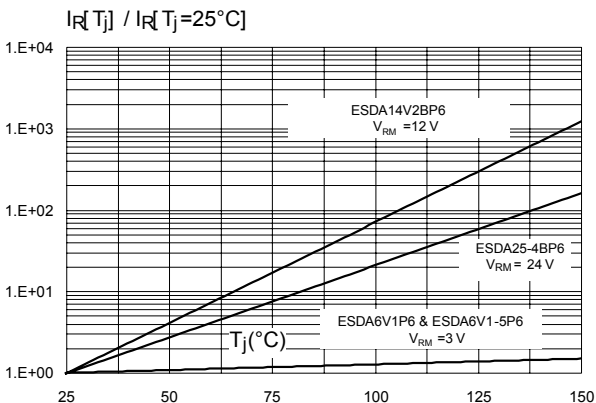

Figure 8. Peak forward voltage drop versus peak forward current (typical values)

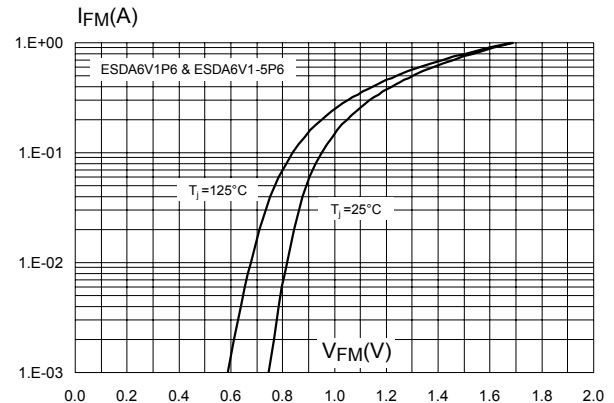

Figure 9. ESD response at $V_{PP} = 15$ kV air discharge (ESDA6V1-5P6)

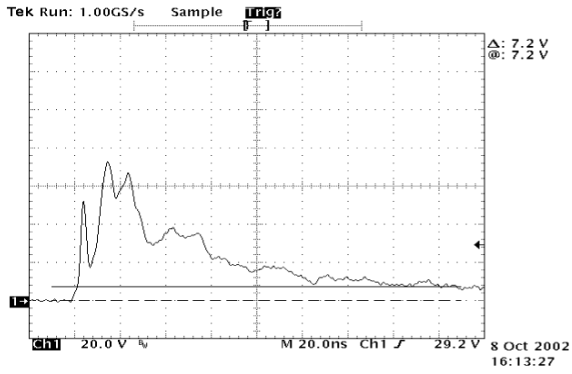
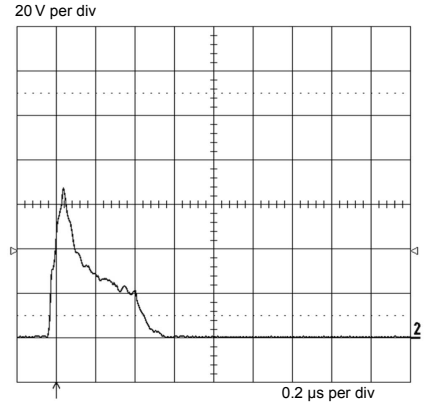

Figure 10. ESD response at $V_{PP} = 15$ kV air discharge (ESDA25-4BP6)



2 Package information

In order to meet environmental requirements, ST offers these devices in different grades of **ECOPACK** packages, depending on their level of environmental compliance. ECOPACK specifications, grade definitions and product status are available at: www.st.com. ECOPACK is an ST trademark.

2.1 SOT-666 package information

Figure 11. SOT-666 package outline

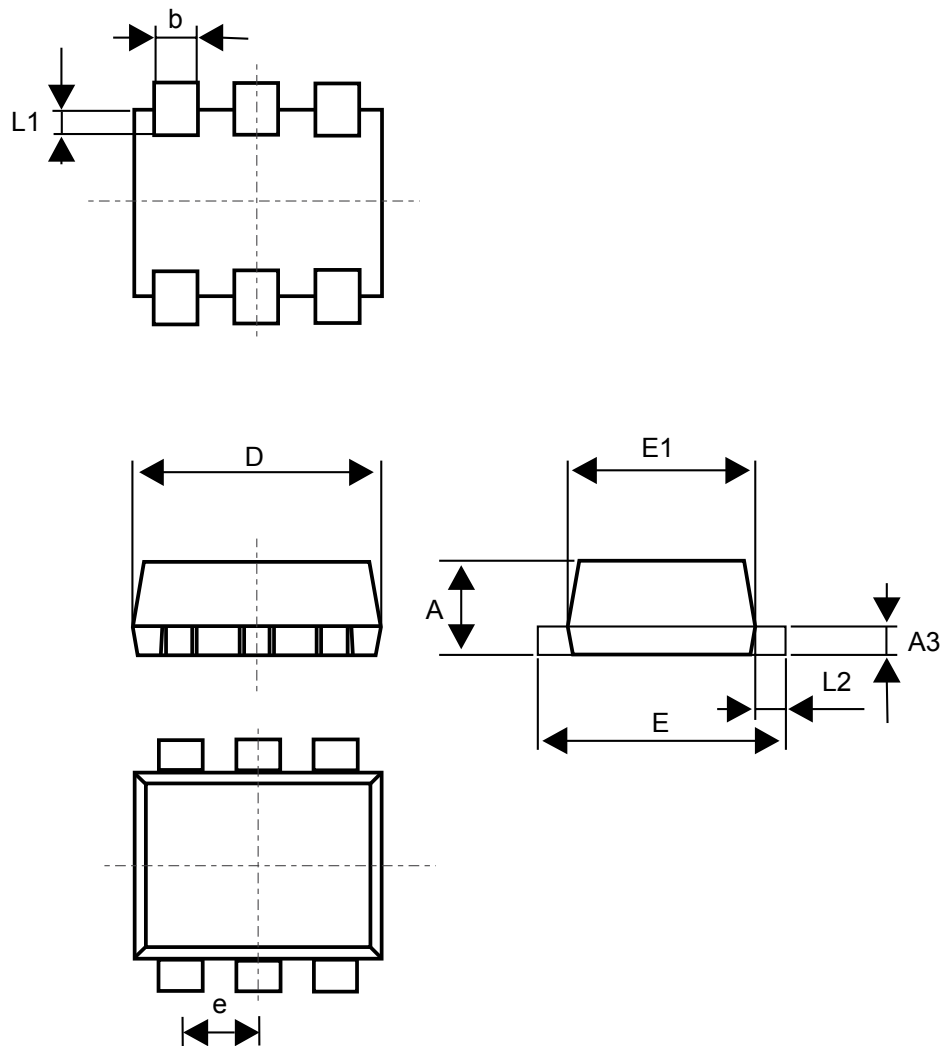
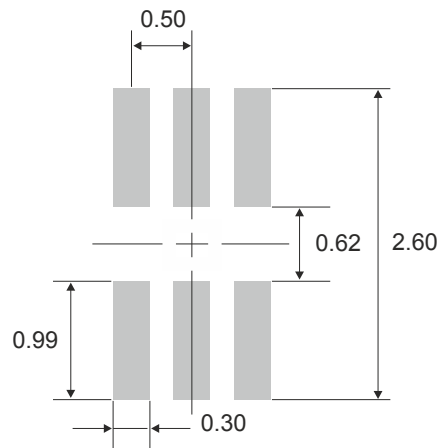

Table 3. SOT-666 package mechanical data

Ref.	Dimensions					
	Millimeters			Inches		
	Min.	Typ.	Max.	Min.	Typ.	Max.
A	0.45		0.62	0.018		0.025
A3	0.08		0.18	0.003		0.007
b	0.17		0.34	0.007		0.013
D	1.50		1.70	0.059		0.067
E	1.50		1.70	0.059		0.067
E1	1.10		1.30	0.043		0.051
e		0.50			0.020	
L1		0.19			0.007	
L2	0.10		0.30	0.004		0.012

Figure 12. Footprint recommendations, dimensions in mm



2.2 SOT-666IP package information

Figure 13. SOT-666IP package outline

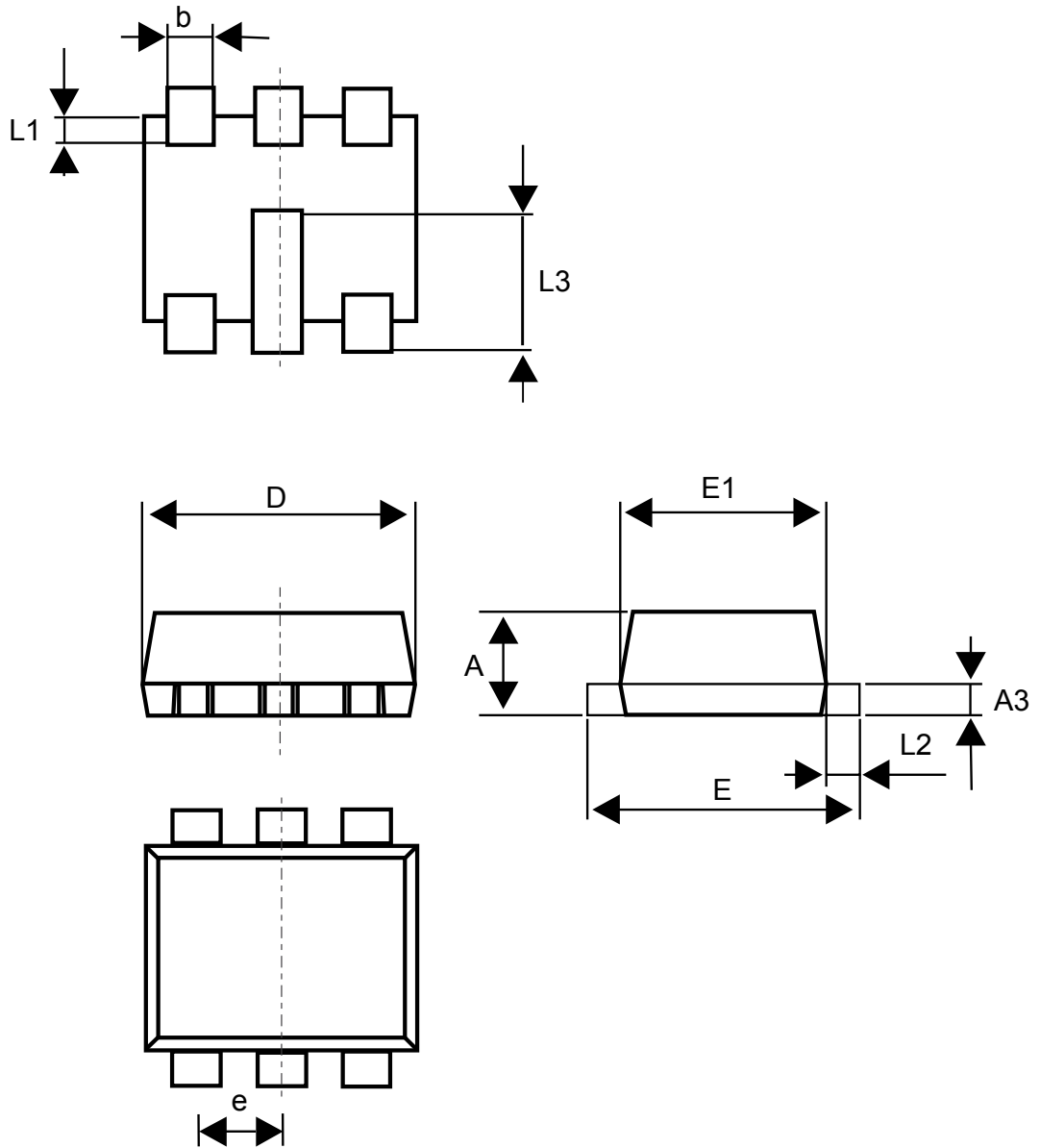
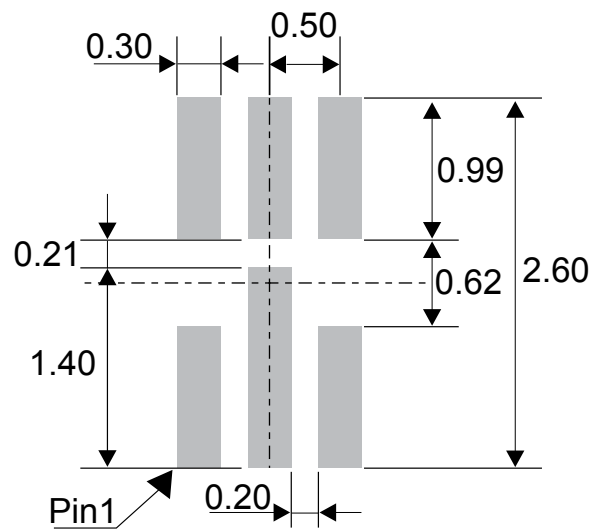

Table 4. SOT-666IP package mechanical data

Ref.	Dimensions					
	Millimeters			Inches		
	Min.	Typ.	Max.	Min.	Typ.	Max.
A	0.45		0.62	0.018		0.025
A3	0.08		0.18	0.003		0.007
b	0.17		0.34	0.007		0.013
D	1.50		1.70	0.059		0.067
E	1.50		1.70	0.059		0.067
E1	1.10		1.30	0.043		0.051
e		0.50			0.020	
L1		0.19			0.007	
L2	0.10		0.30	0.004		0.012
L3		0.60			0.024	

Figure 14. Footprint recommendations, dimensions in mm



3 Ordering information

Table 5. Ordering information

Order code	Marking	Package	Weight	Base qty.	Delivery mode
ESDA6V1P6	B	SOT-666IP	2.9 mg	3000	Tape and reel
ESDA6V1-5P6	C				
ESDA14V2BP6	A	SOT-666			
ESDA25-4BP6	V				

Revision history

Table 6. Document revision history

Date	Version	Changes
07-Feb-2006	1	ESDA6V1P6, ESDA6V1-5P6 and ESDA14V2BP6: datasheets merged. ECOPACK statement added. Some curves combined.
26-Jun-2006	2	Reformatted to current standards. Modified package information to show both SOT-666 and SOT-666IP.
22-May-2007	3	Added product ESDA25-4BP6.
25-Sep-2019	4	Updated Table 1 and title description.
22-Jun-2020	5	Updated Table 2 .

IMPORTANT NOTICE – PLEASE READ CAREFULLY

STMicroelectronics NV and its subsidiaries (“ST”) reserve the right to make changes, corrections, enhancements, modifications, and improvements to ST products and/or to this document at any time without notice. Purchasers should obtain the latest relevant information on ST products before placing orders. ST products are sold pursuant to ST’s terms and conditions of sale in place at the time of order acknowledgement.

Purchasers are solely responsible for the choice, selection, and use of ST products and ST assumes no liability for application assistance or the design of Purchasers’ products.

No license, express or implied, to any intellectual property right is granted by ST herein.

Resale of ST products with provisions different from the information set forth herein shall void any warranty granted by ST for such product.

ST and the ST logo are trademarks of ST. For additional information about ST trademarks, please refer to www.st.com/trademarks. All other product or service names are the property of their respective owners.

Information in this document supersedes and replaces information previously supplied in any prior versions of this document.

© 2020 STMicroelectronics – All rights reserved

Mouser Electronics

Authorized Distributor

Click to View Pricing, Inventory, Delivery & Lifecycle Information:

[STMicroelectronics:](#)

[ESDA6V1P6](#) [ESDA14V2BP6](#) [ESDA6V1-5P6](#) [ESDA25-4BP6](#)