

Features

- Ultra High Efficiency (Up to 93.5%)
- Full Power at Wide Output Current Range (Constant Power)
- 0-5V/0-10V/PWM/Timer Dimmable
- Input Surge Protection: 6kV line-line, 10kV line-earth
- All-Around Protection: OVP, SCP, OTP
- Waterproof (IP67)
- SELV Output
- Suitable for Independent Use
- 7 Years Warranty



Description

The EUG-150SxxxDV series is a 150W, constant-current, programmable LED driver that operates from 90-305 Vac input with excellent power factor. It is created for many lighting applications including high bay, tunnel and roadway lights. The high efficiency of these drivers and compact metal case enables them to run cooler, significantly improving reliability and extending product life. To ensure trouble-free operation, protection is provided against input surge, output over voltage, short circuit, and over temperature.

Models

Adjustable Output Current Range	Full-Power Current Range (1)	Default Output Current	Input Voltage Range(2)	Output Voltage Range	Max. Output Power	Typical Efficiency (3)	Power Factor		Model Number (4)
							120Vac	220Vac	
45-700mA	450-700mA	530 mA	90~305 Vac 100~250 Vdc	117~333Vdc	150 W	93.5%	0.99	0.96	EUG-150S070DV
70-1050mA	700-1050mA	700 mA	90~305 Vac 100~250 Vdc	75~214Vdc	150 W	93.5%	0.99	0.96	EUG-150S105DV
140-2100mA	1400-2100mA	1400 mA	90~305 Vac 100~250 Vdc	38~107Vdc	150 W	92.5%	0.99	0.96	EUG-150S210DV ⁽⁵⁾
245-3500mA	2450-3500mA	3150 mA	90~305 Vac 100~250 Vdc	22 ~ 61Vdc	150 W	92.0%	0.99	0.96	EUG-150S350DV ⁽⁵⁾
385-5600mA	3850-5600mA	4200 mA	90~305 Vac 100~250 Vdc	14 ~ 39Vdc	150 W	92.0%	0.99	0.96	EUG-150S560DV ⁽⁵⁾

- Notes:** (1) Output current range with constant power at 150W
 (2) Certified Voltage range: 100-240Vac or 100-250Vdc (except CCC, PSE, KS and BIS).
 (3) Measured at full load and 220Vac input (see below “General Specifications” for details).
 (4) All the models are certificated to KS, except EUG-150S070DV
 (5) SELV Output.

I-V Operation Area

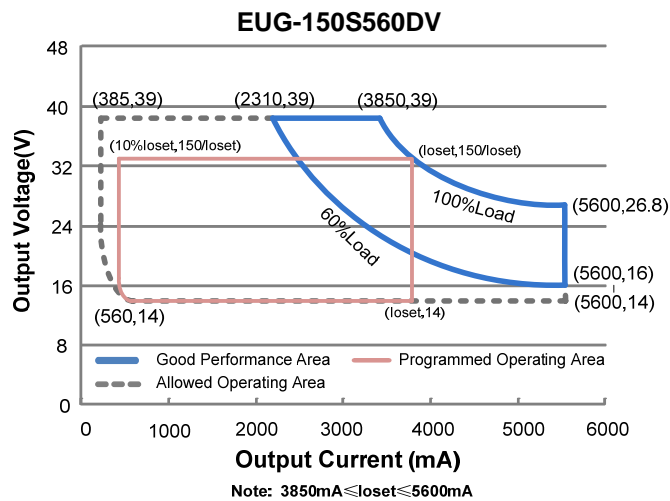
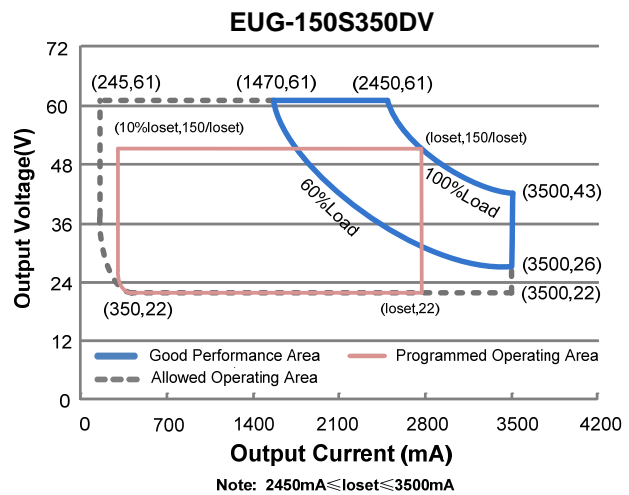
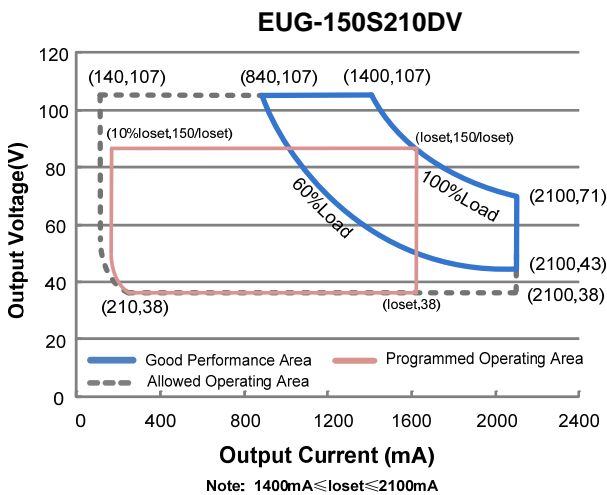
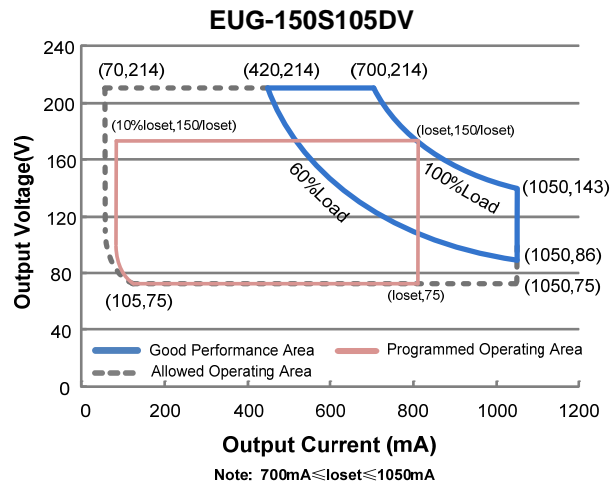
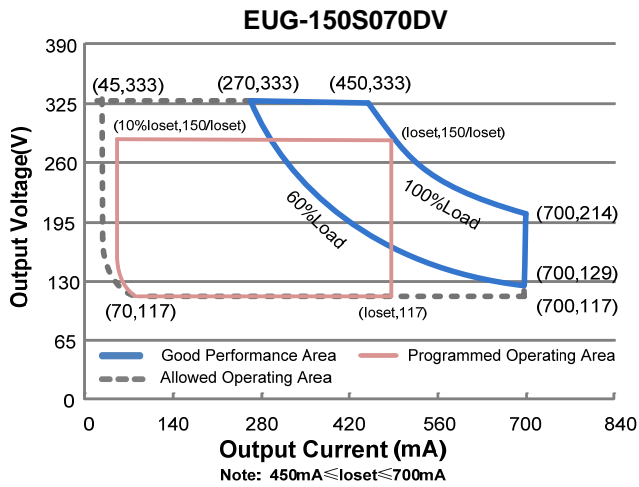

Input Specifications

Parameter	Min.	Typ.	Max.	Notes
Input Voltage	90 Vac	-	305 Vac	100-250Vdc
Input Frequency	47 Hz	-	63 Hz	
Leakage Current	-	-	0.70 mA	IEC60598-1; 240Vac/ 60 Hz
Input AC Current	-	-	1.87 A	Measured at full load and 100 Vac input.
	-	-	0.81 A	Measured at full load and 220 Vac input.
Inrush Current(I ² t)	-	-	1.98 A ² s	At 220Vac input, 25 °C cold start, duration=712 μs, 10%l _{pk} -10%l _{pk} . See Inrush Current Waveform for the details.
PF	0.9	-	-	At 100-240Vac, 50-60Hz, 60%-100% Load (90-150 W)
THD	-	-	20%	
THD	-	-	10%	At 220-240Vac, 50-60Hz, 75%-100% Load (112.5-150 W)

Output Specifications

Parameter	Min.	Typ.	Max.	Notes
Output Current Tolerance	-5%loset	-	5%loset	At full load condition
Output Current Setting(loset) Range				
EUG-150S070DV	45 mA	-	700 mA	
EUG-150S105DV	70 mA	-	1050 mA	
EUG-150S210DV	140 mA	-	2100 mA	
EUG-150S350DV	245 mA	-	3500 mA	
EUG-150S560DV	385 mA	-	5600 mA	
Output Current Setting Range with Constant Power				
EUG-150S070DV	450 mA	-	700 mA	
EUG-150S105DV	700 mA	-	1050 mA	
EUG-150S210DV	1400 mA	-	2100 mA	
EUG-150S350DV	2450 mA	-	3500 mA	
EUG-150S560DV	3850 mA	-	5600 mA	
Total Output Current Ripple (pk-pk)	-	5%lomax	10%lomax	At full load condition, 20 MHz BW
Output Current Ripple at < 200 Hz (pk-pk)	-	2%lomax	-	At full load condition. Only this component of ripple is associated with visible flicker.
Startup Overshoot Current	-	-	10%lomax	At full load condition
No Load Output Voltage				
EUG-150S070DV	-	-	370 V	
EUG-150S105DV	-	-	235 V	
EUG-150S210DV	-	-	120 V	
EUG-150S350DV	-	-	75 V	
EUG-150S560DV	-	-	48 V	
Line Regulation	-	-	±0.5%	Measured at full load
Load Regulation	-	-	±1.5%	

Output Specifications (Continued)

Parameter	Min.	Typ.	Max.	Notes
Turn-on Delay Time	-	-	1.0 s	Measured at 120Vac input, 60%-100% Load
	-	-	0.5 s	Measured at 220Vac input, 60%-100% Load
Temperature Coefficient of I _o set	-	0.03%/°C	-	Case temperature = 0°C ~T _c max
12V Auxiliary Output Voltage	10.8 V	12 V	13.2 V	
12V Auxiliary Output Source Current	0 mA	-	20 mA	Return terminal is "Dim"

Note: All specifications are typical at 25°C unless otherwise stated.

General Specifications

Parameter	Min.	Typ.	Max.	Notes
Efficiency at 120 Vac input:				Measured at full load and steady-state temperature in 25°C ambient; (Efficiency will be about 2.0% lower if measured immediately after startup.)
EUG-150S070DV				
I _o = 450 mA	87.5%	90.5%	-	
I _o = 700 mA	87.0%	90.0%	-	
EUG-150S105DV				
I _o = 700 mA	88.0%	91.0%	-	
I _o =1050 mA	87.0%	90.0%	-	
EUG-150S210DV				
I _o =1400 mA	87.0%	90.0%	-	
I _o =2100 mA	87.0%	90.0%	-	
EUG-150S350DV				
I _o =2450 mA	87.0%	90.0%	-	
I _o =3500 mA	86.5%	89.5%	-	
EUG-150S560DV				
I _o =3850 mA	86.5%	89.5%	-	
I _o =5600 mA	85.0%	88.0%	-	
Efficiency at 220 Vac input:				Measured at full load and steady-state temperature in 25°C ambient; (Efficiency will be about 2.0% lower if measured immediately after startup.)
EUG-150S070DV				
I _o = 450 mA	91.5%	93.5%	-	
I _o = 700 mA	90.5%	92.5%	-	
EUG-150S105DV				
I _o = 700 mA	91.5%	93.5%	-	
I _o =1050 mA	90.5%	92.5%	-	
EUG-150S210DV				
I _o =1400 mA	90.5%	92.5%	-	
I _o =2100 mA	90.0%	92.0%	-	
EUG-150S350DV				
I _o =2450 mA	90.0%	92.0%	-	
I _o =3500 mA	90.0%	92.0%	-	
EUG-150S560DV				
I _o =3850 mA	90.0%	92.0%	-	
I _o =5600 mA	88.5%	90.5%	-	

General Specifications (Continued)

Parameter	Min.	Typ.	Max.	Notes
Efficiency at 277 Vac input: EUG-150S070DV I _o = 450 mA I _o = 700 mA EUG-150S105DV I _o = 700 mA I _o =1050 mA EUG-150S210DV I _o =1400 mA I _o =2100 mA EUG-150S350DV I _o =2450 mA I _o =3500 mA EUG-150S560DV I _o =3850 mA I _o =5600 mA	92.0% 91.0% 91.5% 91.0% 91.0% 90.0% 90.5% 90.5% 90.0% 88.5%	94.0% 93.0% 93.5% 93.0% 93.0% 92.0% 92.5% 92.5% 92.0% 90.5%	- - - - - - - - - -	Measured at full load and steady-state temperature in 25°C ambient; (Efficiency will be about 2.0% lower if measured immediately after startup.)
MTBF	-	271,000 Hours	-	Measured at 220 Vac input, 80%Load and 25 °C ambient temperature (MIL-HDBK-217F)
Lifetime	-	99,000 Hours	-	Measured at 220 Vac input, 80%Load and 70 °C case temperature; See lifetime vs. Tc curve for the details
Operating Case Temperature for Safety T _{c_s}	-40°C	-	+90°C	
Operating Case Temperature for Warranty T _{c_w}	-40°C	-	+75°C	Case temperature for 7 years warranty. <i>Please see Inventronics Warranty Statement for complete details.</i>
Storage Temperature	-40°C	-	+85°C	Humidity: 5%RH to 100%RH
Dimensions Inches (L × W × H) Millimeters (L × W × H)	7.40 × 2.66 × 1.56 188 × 67.5 × 39.7			With mounting ear 8.23 × 2.66 × 1.56 209 × 67.5 × 39.7
Net Weight	-	1100 g	-	

Note: All specifications are typical at 25°C unless otherwise stated.

Dimming Specifications

Parameter	Min.	Typ.	Max.	Notes	
Absolute Maximum Voltage on the V _{dim} (+) Pin	-20 V	-	20 V		
Source Current on V _{dim} (+)Pin	200 uA	300 uA	450 uA	V _{dim} (+) = 0 V	
Dimming Output Range	EUG-150S070DV EUG-150S105DV EUG-150S210DV EUG-150S350DV EUG-150S560DV	10%I _o set	-	I _o set	450 mA ≤ I _o set ≤ 700 mA 700 mA ≤ I _o set ≤ 1050 mA 1400 mA ≤ I _o set ≤ 2100 mA 2450 mA ≤ I _o set ≤ 3500 mA 3850 mA ≤ I _o set ≤ 5600 mA
	EUG-150S070DV EUG-150S105DV EUG-150S210DV EUG-150S350DV EUG-150S560DV	45 mA 70 mA 140 mA 245 mA 385 mA	-	I _o set	45 mA ≤ I _o set < 450 mA 70 mA ≤ I _o set < 700 mA 140 mA ≤ I _o set < 1400 mA 245 mA ≤ I _o set < 2450 mA 385 mA ≤ I _o set < 3850 mA

Dimming Specifications (Continued)

Parameter	Min.	Typ.	Max.	Notes
Recommended Dimming Range for 0-5V	0 V	-	5 V	Dimming mode set to 0-5V in PC interface.
Recommended Dimming Range for 0-10V	0 V	-	10 V	Default 0-10V dimming mode with positive logic.
PWM_in High Level	3 V	-	10 V	Dimming mode set to PWM in PC interface.
PWM_in Low Level	-0.3 V	-	0.6 V	
PWM_in Frequency Range	200 Hz	-	2 KHz	
PWM_in Duty Cycle	1%	-	99%	

Note: All specifications are typical at 25°C unless otherwise stated.

Safety & EMC Compliance

Safety Category	Standard
CE	EN 61347-1, EN61347-2-13
KS	KS C 7655
EMI Standards	Notes
EN 55015 ⁽¹⁾	Conducted emission Test & Radiated emission Test
EN 61000-3-2	Harmonic current emissions
EN 61000-3-3	Voltage fluctuations & flicker
EMS Standards	Notes
EN 61000-4-2	Electrostatic Discharge (ESD): 8 kV air discharge, 4 kV contact discharge
EN 61000-4-3	Radio-Frequency Electromagnetic Field Susceptibility Test-RS
EN 61000-4-4	Electrical Fast Transient / Burst-EFT
EN 61000-4-5	Surge Immunity Test: AC Power Line: line to line 6 kV, line to earth 10 kV ⁽²⁾
EN 61000-4-6	Conducted Radio Frequency Disturbances Test-CS
EN 61000-4-8	Power Frequency Magnetic Field Test
EN 61000-4-11	Voltage Dips
EN 61547	Electromagnetic Immunity Requirements Applies To Lighting Equipment

Note: (1) This LED driver meets the EMI specifications above, but EMI performance of a luminaire that contains it depends also on the other devices connected to the driver and on the fixture itself.

(2) To perform electric strength (hi-pot) testing, the "GDT ground disconnect" (nut and metal lock sheet) on the driver end-cap should be removed temporarily to prevent the internal gas discharge tube from conducting (as allowed by IEC 60598-1 Clause 10.2). After testing is completed, these items must be reinstalled to restore line-to-earth surge protection and secure the end cap.

Lifetime vs. Case Temperature

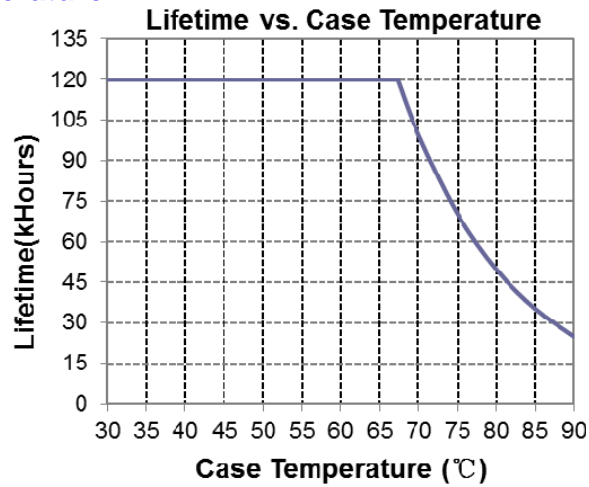

Inrush Current Waveform

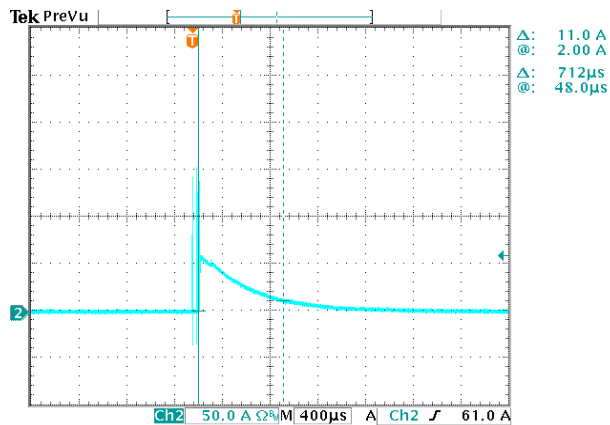

Efficiency vs. Load

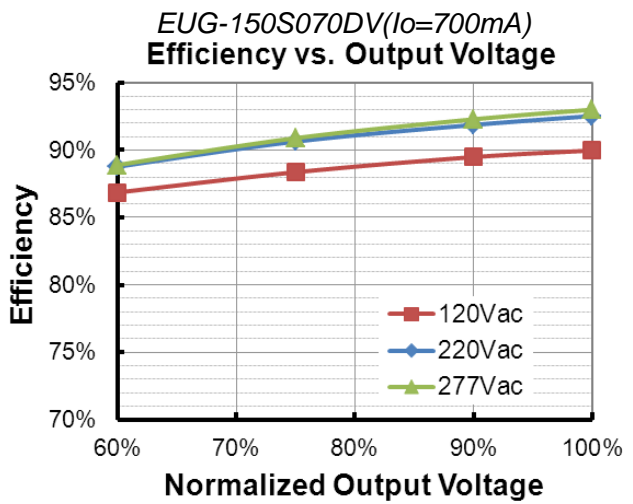
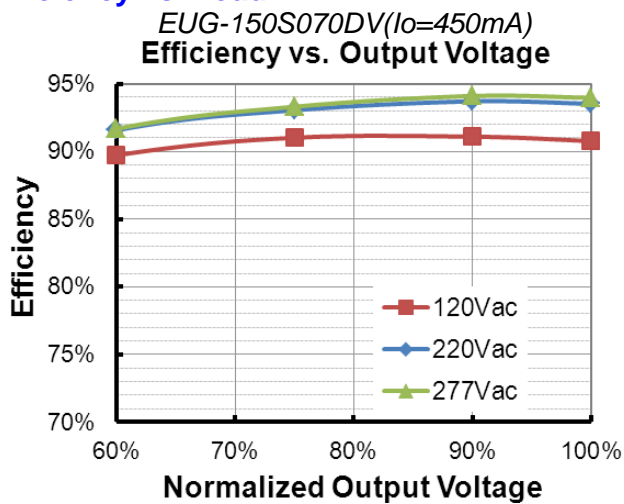

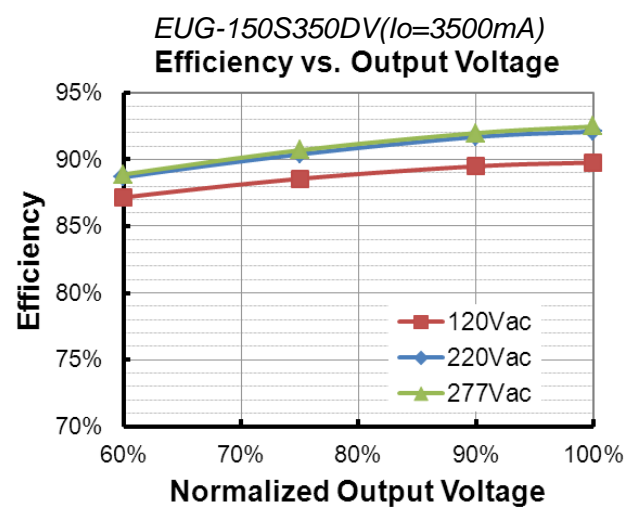
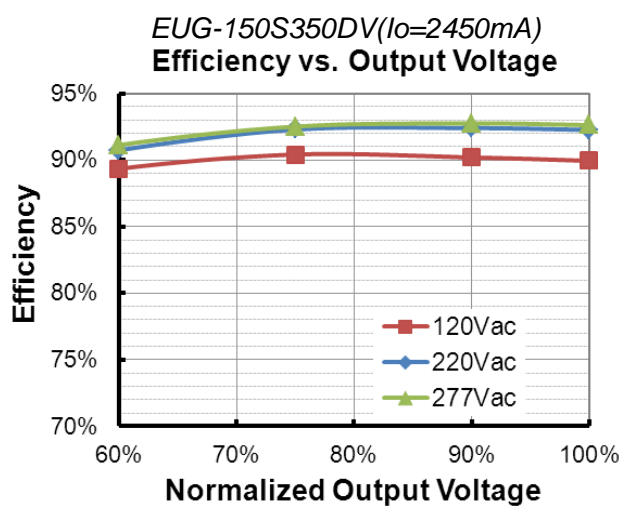
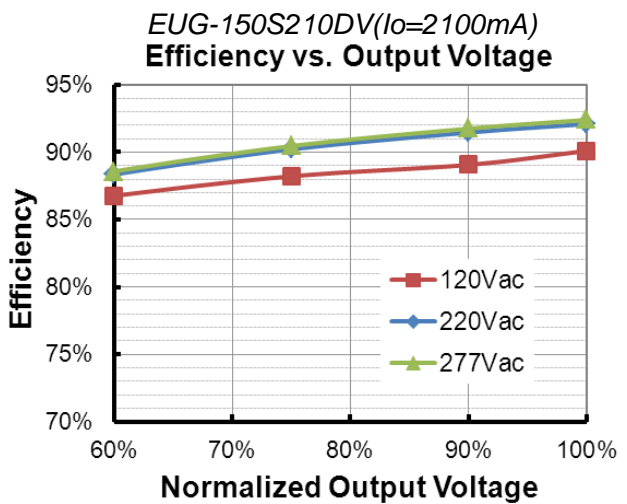
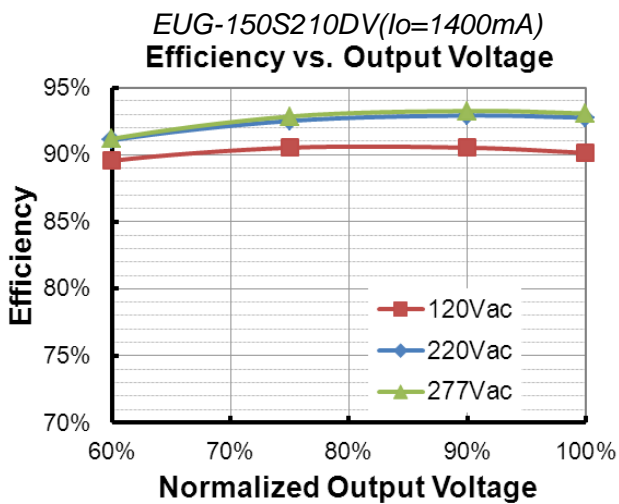
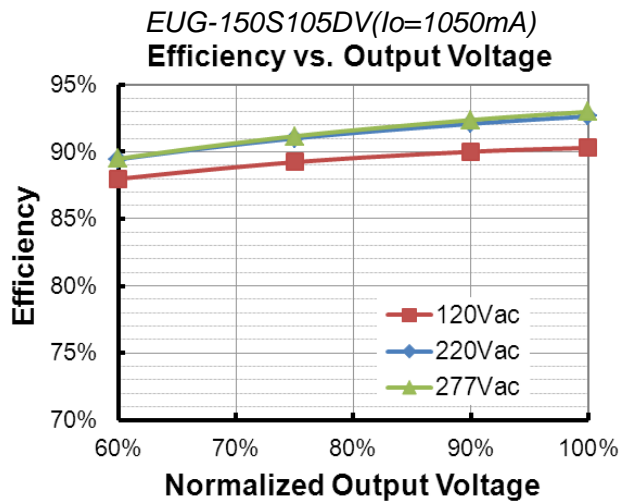
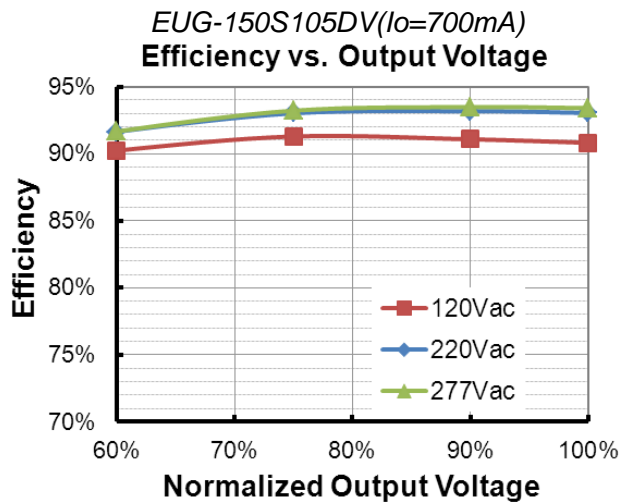

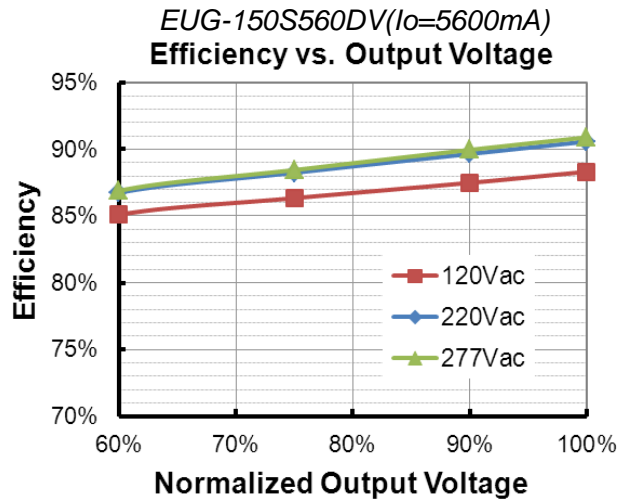
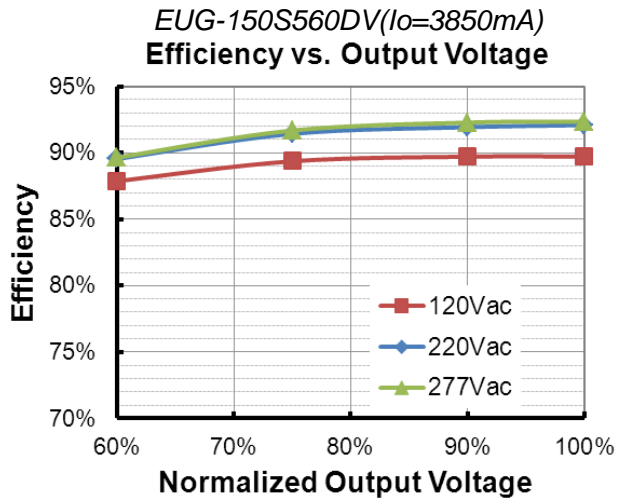

Power Factor

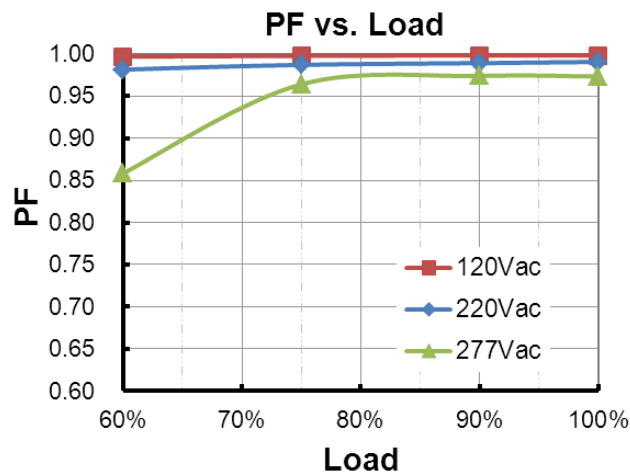

Total Harmonic Distortion

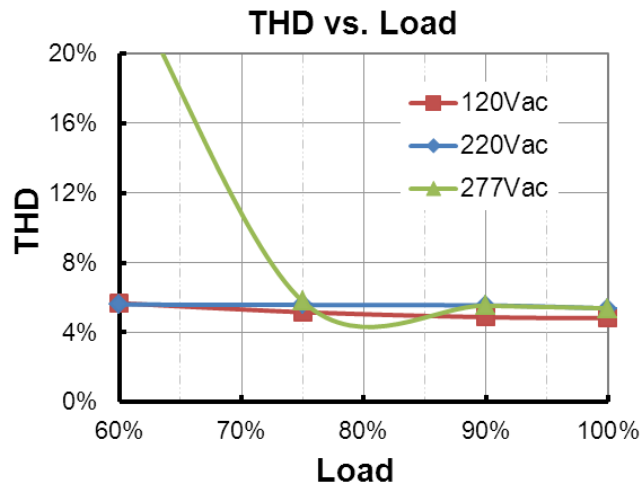

Protection Functions

Parameter	Notes
Over Temperature Protection	Decreases output current, returning to normal after over temperature is removed.
Short Circuit Protection	Auto Recovery. No damage will occur when any output is short circuited. The output shall return to normal when the fault condition is removed.
Over Voltage Protection	Limits output voltage at no load and in case the normal voltage limit fails.

Dimming

● 0-5V Dimming

The recommended implementation of the dimming control is provided below.

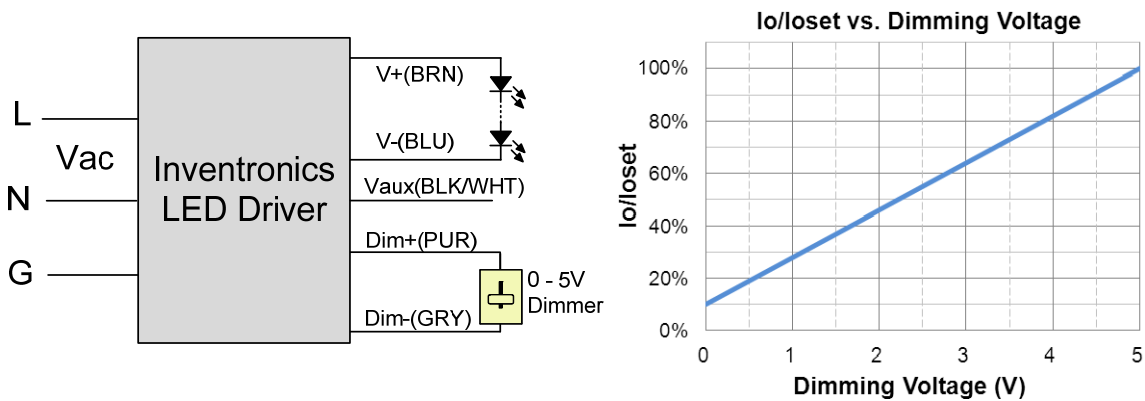

Implementation 1: Positive logic

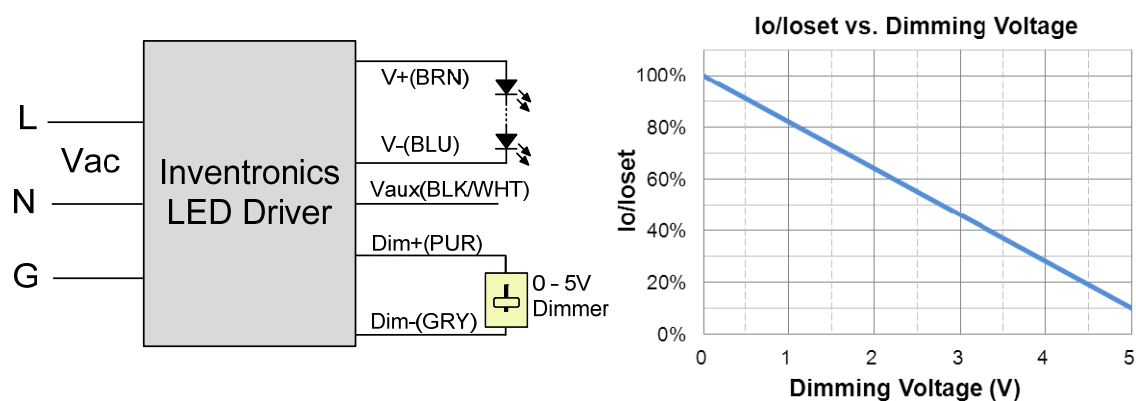

Implementation 2: Negative logic

Notes:

1. The dimmer can also be replaced by an active 0-5V voltage source signal or passive components like resistors and zener.
2. Do NOT connect Dim- to the output V- or V+, otherwise the driver will not work properly.
3. If 0-5V dimming is not used, Dim + should be open.
4. When 0-5V negative logic dimming mode and Dim+ is open, the driver will output maximum current.

● 0-10V Dimming

The recommended implementation of the dimming control is provided below.

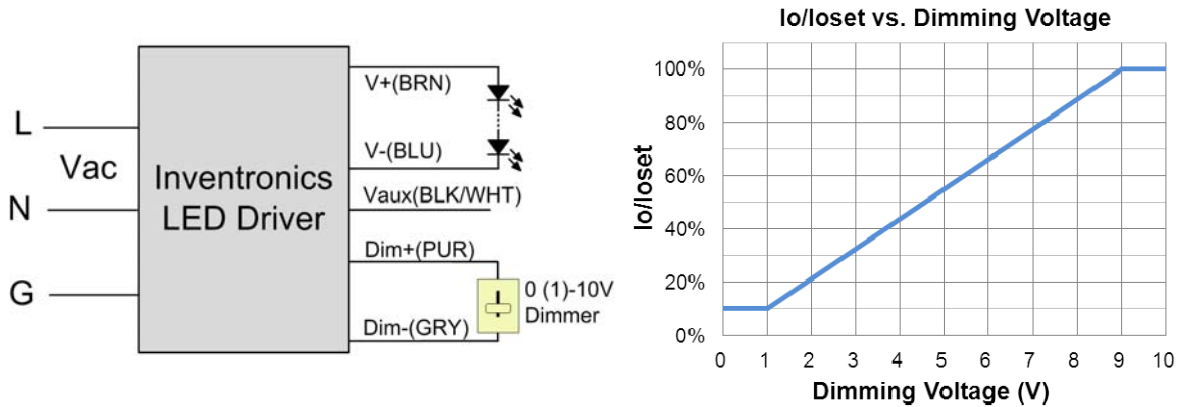

Implementation 3: Positive logic

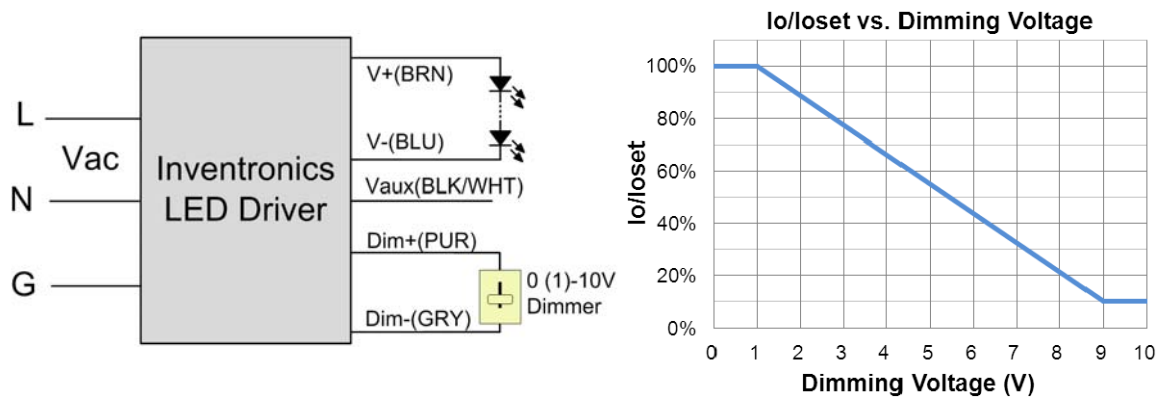

Implementation 4: Negative logic

Notes:

1. The dimmer can also be replaced by an active 0-10V voltage source signal or passive components like resistors and zener.
2. Do NOT connect Dim- to the output V- or V+, otherwise the driver will not work properly.
3. If 0-10V dimming is not used, Dim + should be open.
4. When 0-10V negative logic dimming mode and Dim+ is open, the driver will output minimum current.

● PWM Dimming

The recommended implementation of the dimming control is provided below.

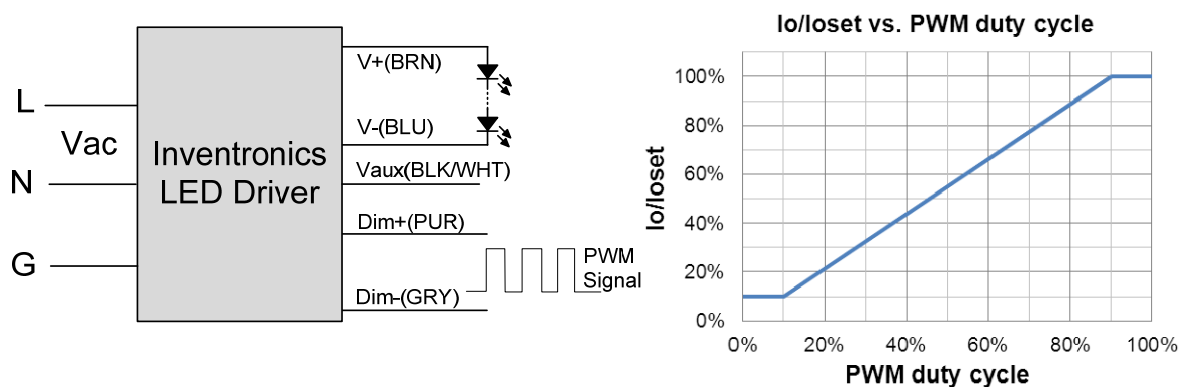

Implementation 5: Positive logic

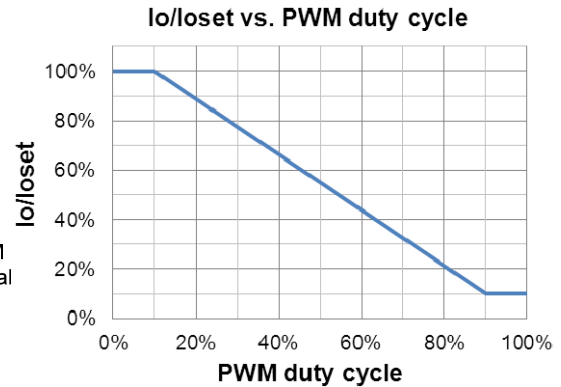
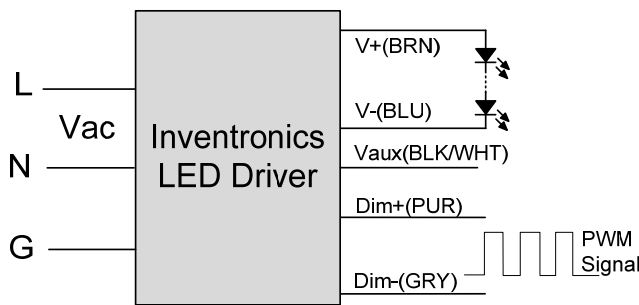

Implementation 6: Negative logic

Notes:

1. Do NOT connect Dim- to the output V- or V+, otherwise the driver will not work properly.
2. If PWM dimming is not used, Dim + should be open.
3. When PWM negative logic dimming mode and Dim+ is open, the driver will output minimum current.

● Time Dimming

Set the timing curve by pulling the sliders.

Programming Connection Diagram

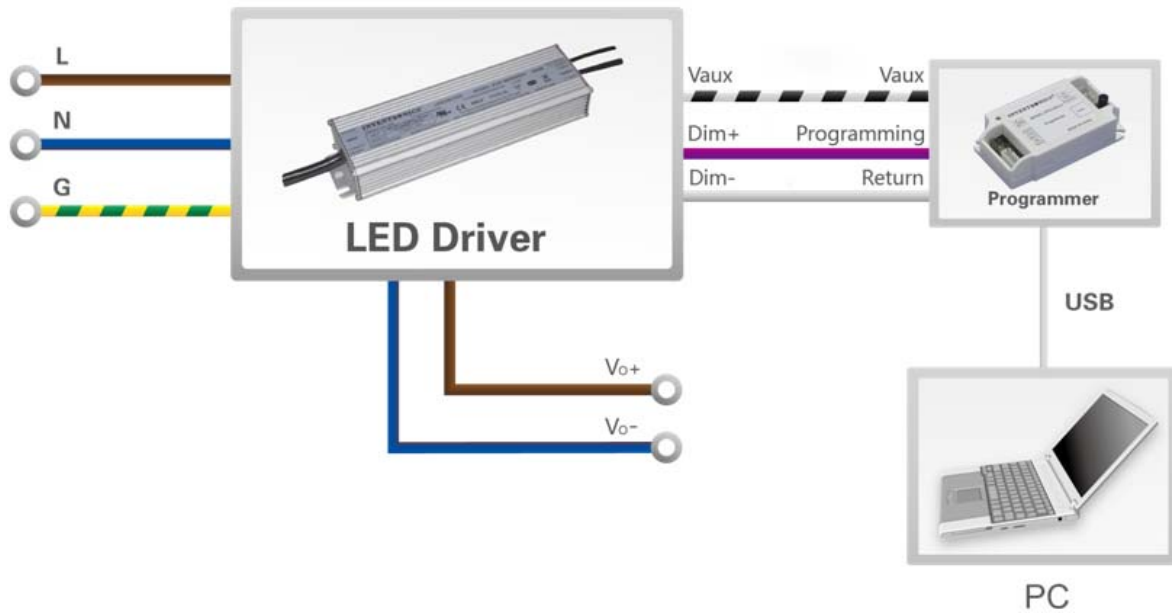

Note: The driver does not need to be powered on during the programming process.

- Please refer to [PRG-MUL2 \(Programmer\)](#) datasheet for details.

Mechanical Outline

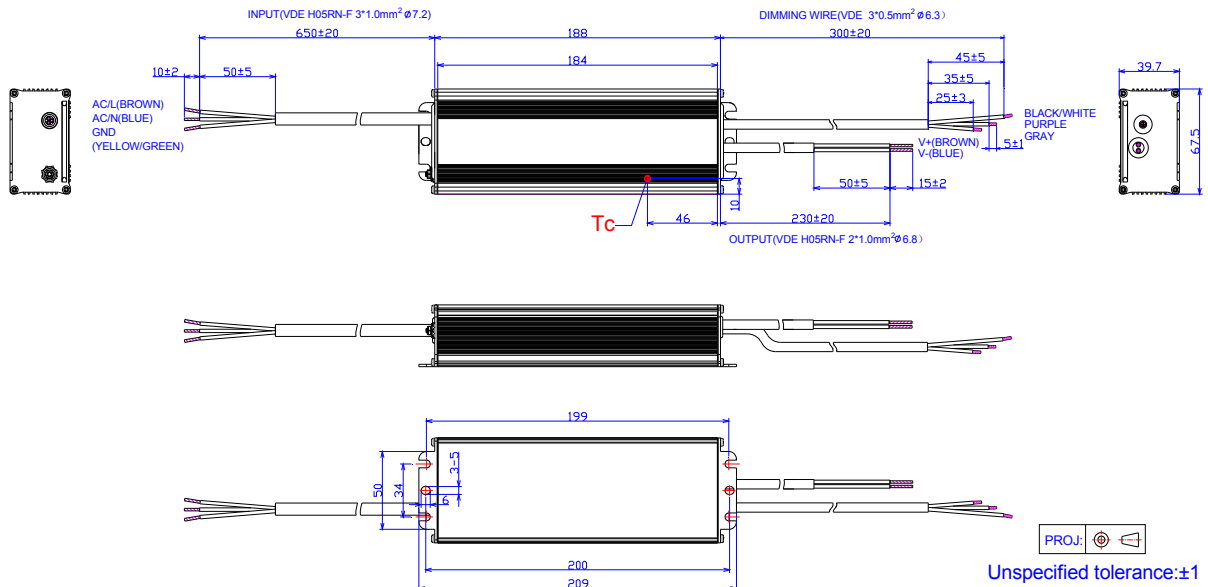

RoHS Compliance

Our products comply with the European Directive 2011/65/EC, calling for the elimination of lead and other hazardous substances from electronic products.

Revision History

Change Date	Rev.	Description of Change		
		Item	From	To
2015-08-07	A	Datasheets Release	/	/
2016-01-12	B	TUV、KS、BIS	/	Added
		EUG-150S070DV	/	Added
2016-04-07	C	Input Specifications	Input AC Current	Updated
		General Specifications	With mounting ear	Added
		General Specifications	Net Weight	Added
		Safety &EMC Compliance	/	Updated
		Mechanical Outline	/	Updated
2017-08-01	D	Input Specifications	PF/THD	Updated
		Output Specifications	Temperature Coefficient of loset	Updated
		General Specifications	Dimensions	Updated
		Safety &EMC Compliance	/	Updated
		Mechanical Outline	/	Updated
2017-10-26	E	Features	7 Years Warranty	Added
		Operating Case Temperature for Warranty Tc_w	/	Updated
2018-01-31	F	Description	/	Updated
		General Specifications	Lifetime	Updated
		General Specifications	Operating Case Temperature for Warranty Tc_w	Updated
		Lifetime vs. Case Temperature	/	Updated