

### Features

- Non-Magnetic Package Suitable for MRI Applications
- Rectangular MELF SMQ Ceramic Package
- Hermetically Sealed
- Low  $R_s$  for Low Insertion Loss
- Long  $\tau_L$  for Low Intermodulation Distortion
- Low  $C_j$  for High Series Isolation
- High Average Incident Power Handling Capability
- RoHS Compliant

### Description and Applications

The MA4P7470F-1072T is a surface mountable PIN diode in a non-magnetic Metal Electrode Leadless Faced (MELF) package. The device incorporates M/A-COM Technology Solutions time proven HIPAX technology to produce a low inductance ceramic package with no ribbons or whisker wires. The package utilizes M/A-COM Technology Solutions new non-magnetic plating process to provide a hermetically sealed package with extremely low permeability. Incorporated within the package is a glass passivated PIN chip that is full face bonded on both the cathode and anode to maximize surface area for low electrical and thermal resistance. The low thermal resistance provides excellent performance at high incident power levels of up to 200 watts CW. The MA4P7470F-1072T has been comprehensively characterized both electrically and mechanically to ensure repeatable and predictable performance. The MA4P7470F-1072T is a non-magnetic device which has similar electrical performance to its magnetic counterpart the MA4P7417F-1072T. The diode is well suited for use in low loss, low distortion, high power switching circuits. It was designed to be used in a high magnetic field environment from HF through UHF frequencies. This device is designed to meet the most rigorous electrical and mechanical requirements of MRI environments.

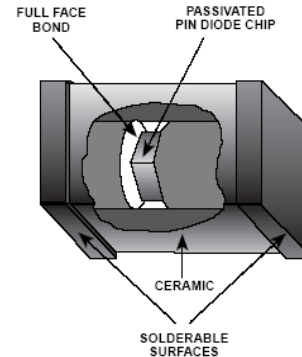

### Designed for Automated Assembly

MELF PIN diodes are designed for high volume tape and reel assembly. The rectangular package design is excellent for automatic pick and place assembly methods. The parallel flat surfaces are suitable for key jaw or vacuum pickup techniques. All solderable surfaces are tin plated and compatible with industry standard reflow and vapor phase soldering methods.

### Absolute Maximum Ratings<sup>1</sup> @ +25°C

Parameter	Absolute Maximum
Operating Temperature	-65°C to +125°C
Storage Temperature	-65°C to +150°C
Chip Junction Temperature	+175°C Continuous
Diode Mounting Temperature	+265°C for 10 seconds
RF C.W. Incident Power	+53dBm C.W.
Forward D.C. Current	+150 mA
Reverse D.C. Voltage @ -10uA	- 800V

1. Exceeding any of these limits may cause permanent damage.

**ADVANCED:** Data Sheets contain information regarding a product M/A-COM is considering for development. Performance is based on target specifications, simulated results, and/or prototype measurements. Commitment to develop is not guaranteed.

**PRELIMINARY:** Data Sheets contain information regarding a product M/A-COM has under development. Performance is based on engineering tests. Specifications are typical. Mechanical outline has been fixed. Engineering samples and/or test data may be available. Commitment to produce in volume is not guaranteed.

- **North America** Tel: 800.366.2266 / Fax: 978.366.2266
- **Europe** Tel: 44.1908.574.200 / Fax: 44.1908.574.300
- **Asia/Pacific** Tel: 81.44.844.8296 / Fax: 81.44.844.8298

Visit [www.macom.com](http://www.macom.com) for additional data sheets and product information.

M/A-COM Inc. and its affiliates reserve the right to make changes to the product(s) or information contained herein without notice.

### Electrical Specifications @ +25 °C

Parameter	Symbol	Condition	Unit Value
Maximum Forward Voltage	$V_F$	$I_F = +100\text{mA}$	$1.0V_{DC}$
Minimum Reverse Voltage <sup>1</sup>	$V_R$	$I_r = -10\mu\text{A}$	$I - 800 I V_{DC}$
Maximum Total Capacitance	$C_T$	-100V @ 100MHz	0.7pF
Maximum Series Resistance	$R_S$	+100mA @ 100MHz	0.8 $\Omega$
Minimum Parallel Resistance	$R_P$	-10V @ 100MHz	50K $\Omega$
Nominal Carrier Lifetime	$\tau_L$	+6mA / -10mA @ (50% - 90% Voltage)	6.5 $\mu\text{s}$
Nominal I-Region Length	$\mu\text{m}$	-	140 $\mu\text{m}$
Maximum Thermal Resistance	$\theta$	$I_H = 1\text{A}, I_L = 10\text{mA},$ $T = 1\text{mS}$	13°C/W
Maximum Power Dissipation in Free Air	$W$	$I_F = +100\text{mA}$	4W
Maximum Power Dissipation with heatsink	$P_D$	$I_F = +100\text{mA}$	12W

Note:

1. The minimum specified  $V_R$  (Reverse Voltage) is sourced and the resultant reverse leakage current,  $I_r$ , is measured to be  $<10\mu\text{A}$

### Environmental Screening Capability

MELF devices may be used in industrial or military applications and can be screened to meet the environmental requirements of MIL-STD-750, MIL-STD-202 as well as other military standards. The table below lists some of the MIL-STD 750 tests the device is designed to meet.

MIL-STD-750		
Test	Method	Description
High Temperature Storage	1031	+150°C, for 340 Hours
Temperature Shock	1051	-65°C to +125°C, 20 Cycles
HTRB	1038	80% of rated $V_R$ , +150°C, for 96 Hours
Moisture Resistance	1021	No Initial Conditioning, 85 % RH, +85°C
Gross Leak	1071 Cond. E	Dye Penetrant Visual
Vibration Fatigue	2046	20,000 G's, 60 Hz, x, y, z axis
Solderability	2026	Test Temperature = +245°C

**ADVANCED:** Data Sheets contain information regarding a product M/A-COM is considering for development. Performance is based on target specifications, simulated results, and/or prototype measurements. Commitment to develop is not guaranteed.

**PRELIMINARY:** Data Sheets contain information regarding a product M/A-COM has under development. Performance is based on engineering tests. Specifications are typical. Mechanical outline has been fixed. Engineering samples and/or test data may be available. Commitment to produce in volume is not guaranteed.

- **North America** Tel: 800.366.2266 / Fax: 978.366.2266
- **Europe** Tel: 44.1908.574.200 / Fax: 44.1908.574.300
- **Asia/Pacific** Tel: 81.44.844.8296 / Fax: 81.44.844.8298

Visit [www.macom.com](http://www.macom.com) for additional data sheets and product information.

M/A-COM Inc. and its affiliates reserve the right to make changes to the product(s) or information contained herein without notice.

## Typical Electrical Performance

MA4P7470F-1072T Rs vs I

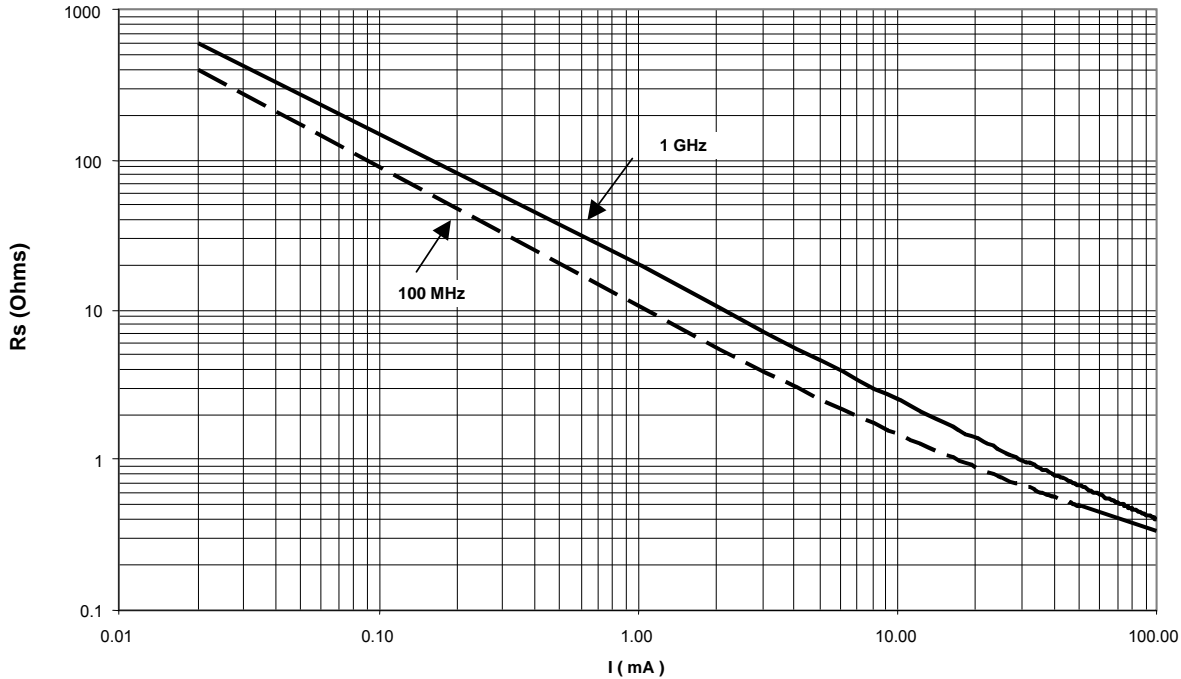

MA4P7470F-1072T Rp vs Voltage

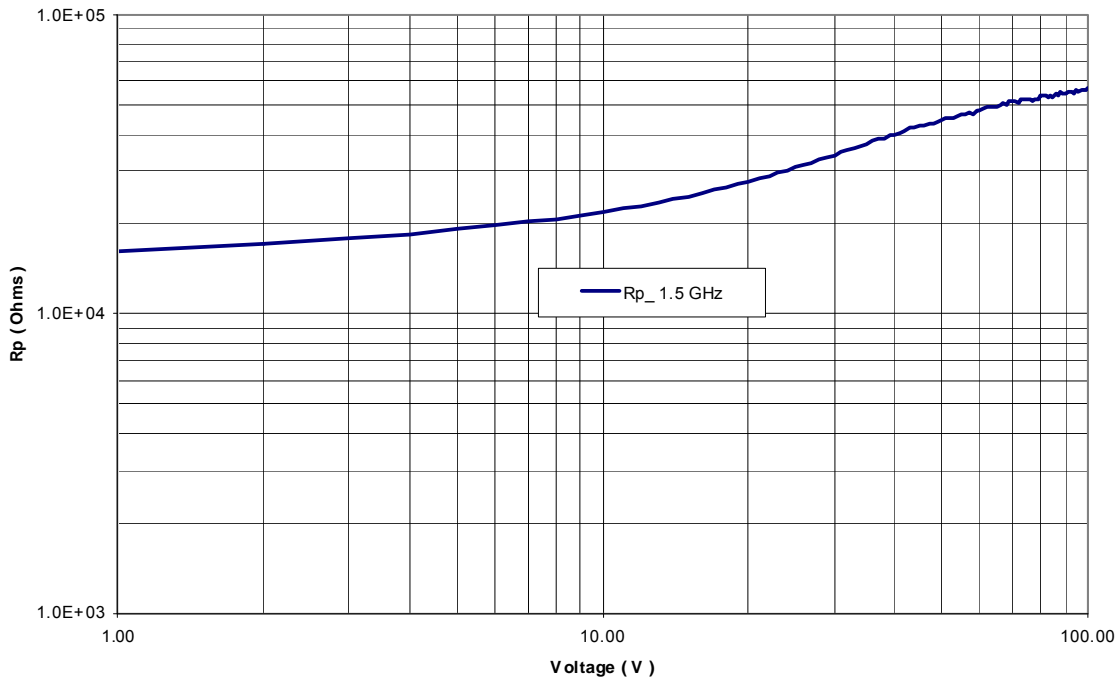

**ADVANCED:** Data Sheets contain information regarding a product M/A-COM is considering for development. Performance is based on target specifications, simulated results, and/or prototype measurements. Commitment to develop is not guaranteed.

**PRELIMINARY:** Data Sheets contain information regarding a product M/A-COM has under development. Performance is based on engineering tests. Specifications are typical. Mechanical outline has been fixed. Engineering samples and/or test data may be available. Commitment to produce in volume is not guaranteed.

- **North America** Tel: 800.366.2266 / Fax: 978.366.2266
- **Europe** Tel: 44.1908.574.200 / Fax: 44.1908.574.300
- **Asia/Pacific** Tel: 81.44.844.8296 / Fax: 81.44.844.8298

Visit [www.macom.com](http://www.macom.com) for additional data sheets and product information.

M/A-COM Inc. and its affiliates reserve the right to make changes to the product(s) or information contained herein without notice.

## Typical Electrical Performance

MA4P7470F-1072T Ct vs Voltage

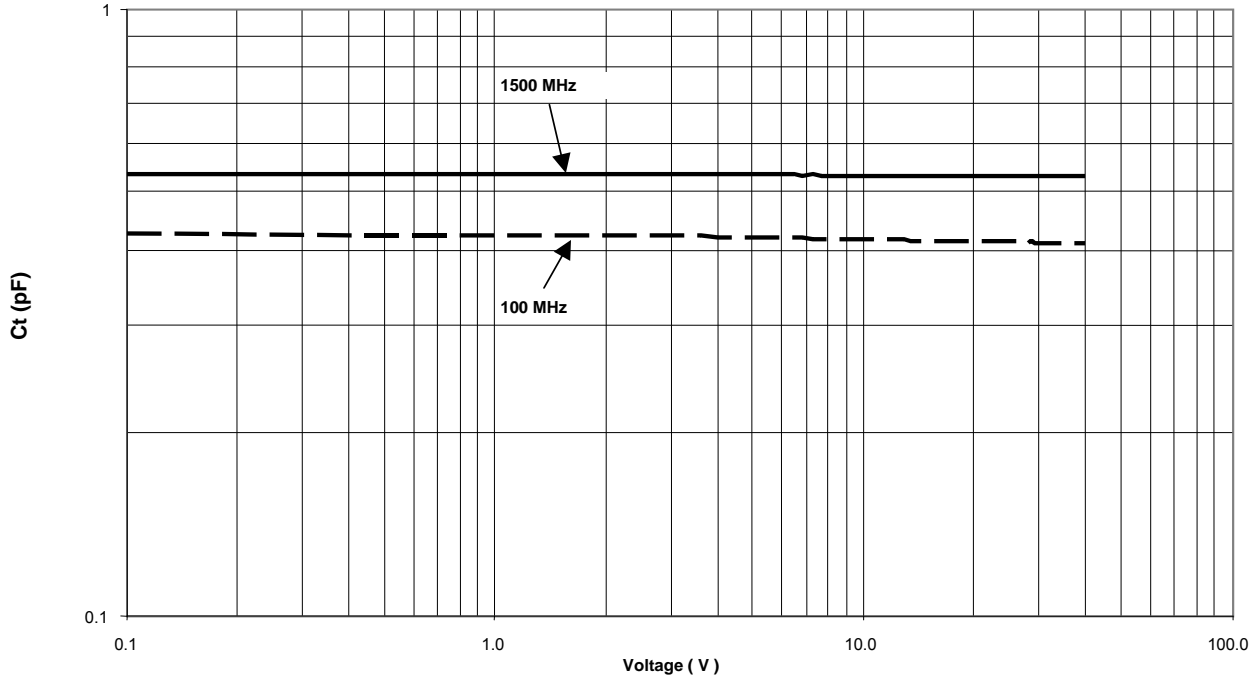

MA4P7470F-1072T Ls vs Frequency

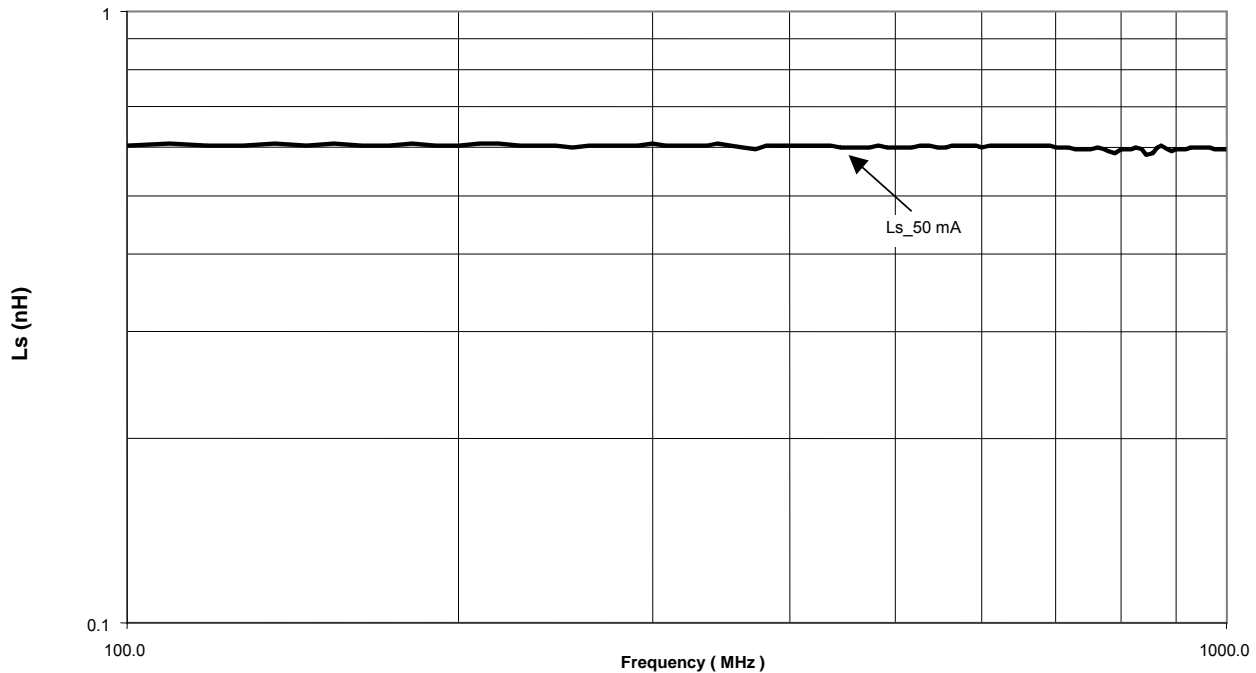

**ADVANCED:** Data Sheets contain information regarding a product M/A-COM is considering for development. Performance is based on target specifications, simulated results, and/or prototype measurements. Commitment to develop is not guaranteed.

**PRELIMINARY:** Data Sheets contain information regarding a product M/A-COM has under development. Performance is based on engineering tests. Specifications are typical. Mechanical outline has been fixed. Engineering samples and/or test data may be available. Commitment to produce in volume is not guaranteed.

- **North America** Tel: 800.366.2266 / Fax: 978.366.2266
- **Europe** Tel: 44.1908.574.200 / Fax: 44.1908.574.300
- **Asia/Pacific** Tel: 81.44.844.8296 / Fax: 81.44.844.8298

Visit [www.macom.com](http://www.macom.com) for additional data sheets and product information.

M/A-COM Inc. and its affiliates reserve the right to make changes to the product(s) or information contained herein without notice.

### Typical Non-Magnetic Performance

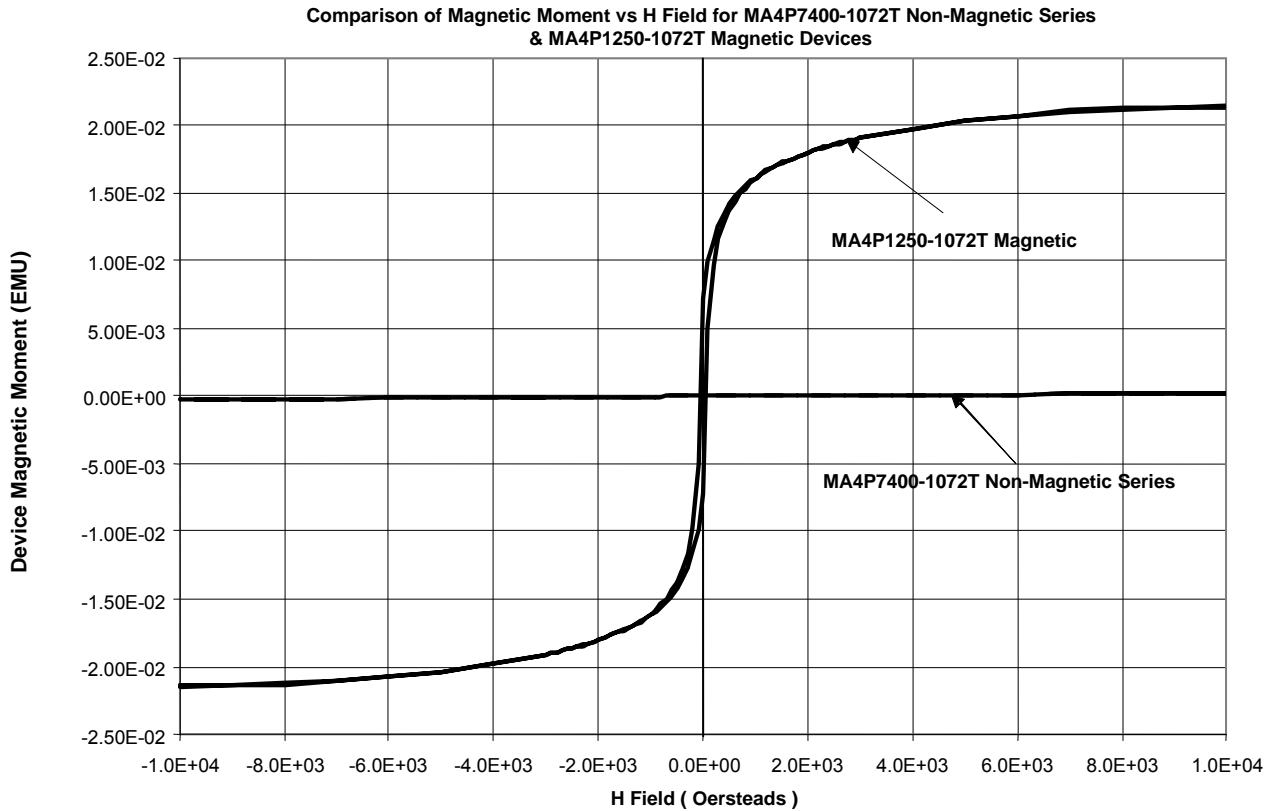

**Table 1 - Typical Magnetic Properties of Non-Magnetic MA4P7470F-1072T Device vs. A Conventional Magnetic MA4P1250-1072T Device**

Magnetic Property	MA4P7470F-1072T Value	MA4P1250-1072T Value
Saturation Moment (EMU) @ H = H <sub>MAX</sub> Oersteds	2.3 x E <sup>-4</sup>	2.1 x E <sup>-2</sup>
Remanance Moment (EMU) @ H = 0 Oersteds	4.2 x E <sup>-8</sup>	7.1 x E <sup>-3</sup>
Coercivity (Oersteds) @ EMU = 0 Moment	1	59.2

**ADVANCED:** Data Sheets contain information regarding a product M/A-COM is considering for development. Performance is based on target specifications, simulated results, and/or prototype measurements. Commitment to develop is not guaranteed.

**PRELIMINARY:** Data Sheets contain information regarding a product M/A-COM has under development. Performance is based on engineering tests. Specifications are typical. Mechanical outline has been fixed. Engineering samples and/or test data may be available. Commitment to produce in volume is not guaranteed.

- **North America** Tel: 800.366.2266 / Fax: 978.366.2266
- **Europe** Tel: 44.1908.574.200 / Fax: 44.1908.574.300
- **Asia/Pacific** Tel: 81.44.844.8296 / Fax: 81.44.844.8298

Visit [www.macom.com](http://www.macom.com) for additional data sheets and product information.

M/A-COM Inc. and its affiliates reserve the right to make changes to the product(s) or information contained herein without notice.

### 1072 Package Dimensions

Dimension	INCHES		MM	
	MIN.	MAX.	MIN.	MAX.
A	0.080	0.095	2.032	2.413
B	0.115	0.135	2.921	3.429
C	0.008	0.030	0.203	0.762

### 1072 Circuit Pad Layout

Dimension	Package Style 1072	
	inches	mm
A	0.093	2.36
B	0.050	1.27
C	0.060	1.52

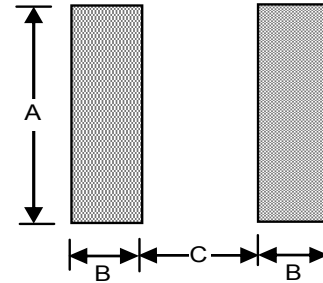
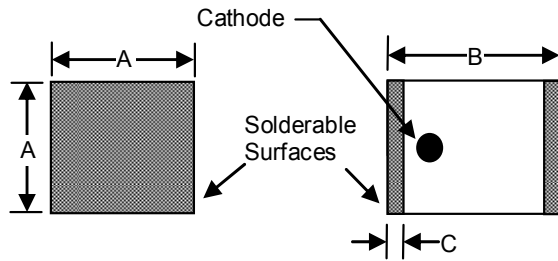

### Ordering Information

Part Number	Package
MA4P7470F-1072T	Tape and Reel

**ADVANCED:** Data Sheets contain information regarding a product M/A-COM is considering for development. Performance is based on target specifications, simulated results, and/or prototype measurements. Commitment to develop is not guaranteed.

**PRELIMINARY:** Data Sheets contain information regarding a product M/A-COM has under development. Performance is based on engineering tests. Specifications are typical. Mechanical outline has been fixed. Engineering samples and/or test data may be available. Commitment to produce in volume is not guaranteed.

- **North America** Tel: 800.366.2266 / Fax: 978.366.2266
- **Europe** Tel: 44.1908.574.200 / Fax: 44.1908.574.300
- **Asia/Pacific** Tel: 81.44.844.8296 / Fax: 81.44.844.8298

Visit [www.macom.com](http://www.macom.com) for additional data sheets and product information.

M/A-COM Inc. and its affiliates reserve the right to make changes to the product(s) or information contained herein without notice.

# Mouser Electronics

Authorized Distributor

Click to View Pricing, Inventory, Delivery & Lifecycle Information:

[MACOM:](#)

[MA4P7470F-1072T](#)