

MC74LCX14

Low Voltage CMOS Hex Schmitt Inverter With 5 V-Tolerant Inputs

The MC74LCX14 is a high performance hex inverter with Schmitt-Trigger inputs operating from a 2.3 to 3.6 V supply. High impedance TTL compatible inputs significantly reduce current loading to input drivers, while TTL compatible outputs offer improved switching noise performance. A V_I specification of 5.5 V allows MC74LCX14 inputs to be safely driven from 5.0 V devices.

Pin configuration and function are the same as the MC74LCX04, but the inputs have hysteresis and, with its Schmitt trigger function, the LCX14 can be used as a line receiver which will receive slow input signals.

Features

- Designed for 2.3 V to 3.6 V V_{CC} Operation
- 5.0 V Tolerant Inputs – Interface Capability with 5.0 V TTL Logic
- LVTTTL Compatible
- LVC MOS Compatible
- 24 mA Balanced Output Sink and Source Capability
- Near Zero Static Supply Current (10 μ A) Substantially Reduces System Power Requirements
- Latchup Performance Exceeds 500 mA
- Current Drive Capability is 24 mA at Source/Sink
- Pin and Function Compatible with Other Standard Logic Families
- ESD Performance: Human Body Model >2000 V
Machine Model >100 V
- Chip Complexity: 41 Equivalent Gates
- These Devices are Pb-Free, Halogen Free/BFR Free and are RoHS Compliant



ON Semiconductor®

<http://onsemi.com>

MARKING DIAGRAMS

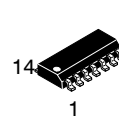

SOIC-14
D SUFFIX
CASE 751A

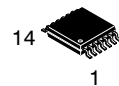
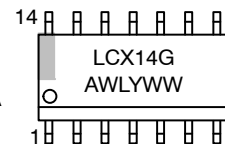

TSSOP-14
DT SUFFIX
CASE 948G

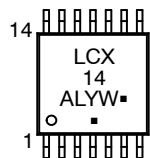

A = Assembly Location
L, WL = Wafer Lot
Y, YY = Year
W, WW = Work Week
G or ■ = Pb-Free Package

(Note: Microdot may be in either location)

ORDERING INFORMATION

See detailed ordering and shipping information in the package dimensions section on page 4 of this data sheet.

MC74LCX14

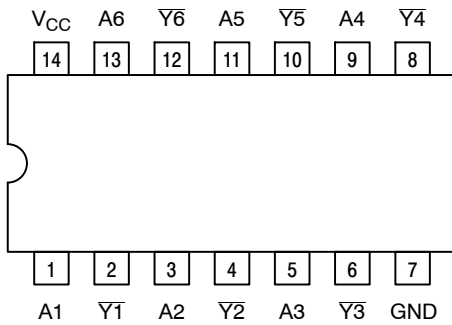

Figure 1. Pinout: 14-Lead (Top View)

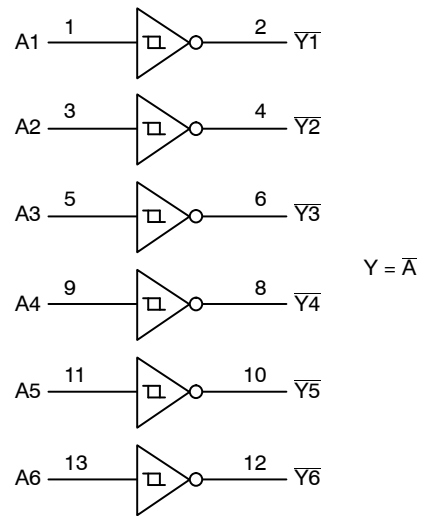

Figure 2. Logic Diagram

PIN NAMES

Pins	Function
A _n	Data Inputs
\bar{Y}_n	Outputs

TRUTH TABLE

Inputs	Outputs
A	\bar{Y}
L	H
H	L

MAXIMUM RATINGS

Symbol	Parameter	Value	Condition	Units
V _{CC}	DC Supply Voltage	-0.5 to +7.0		V
V _I	DC Input Voltage	-0.5 ≤ V _I ≤ +7.0		V
V _O	DC Output Voltage	-0.5 ≤ V _O ≤ V _{CC} + 0.5	Output in HIGH or LOW State. (Note 1)	V
I _{IK}	DC Input Diode Current	-50	V _I < GND	mA
I _{OK}	DC Output Diode Current	-50	V _O < GND	mA
		+50	V _O > V _{CC}	mA
I _O	DC Output Source/Sink Current	±50		mA
I _{CC}	DC Supply Current Per Supply Pin	±100		mA
I _{GND}	DC Ground Current Per Ground Pin	±100		mA
T _{STG}	Storage Temperature Range	-65 to +150		°C
MSL	Moisture Sensitivity		Level 1	

Maximum ratings are those values beyond which device damage can occur. Maximum ratings applied to the device are individual stress limit values (not normal operating conditions) and are not valid simultaneously. If these limits are exceeded, device functional operation is not implied, damage may occur and reliability may be affected.

1. I_O absolute maximum rating must be observed.

MC74LCX14

RECOMMENDED OPERATING CONDITIONS

Symbol	Parameter	Min	Typ	Max	Units
V _{CC}	Supply Voltage Operating Data Retention Only	2.0 1.5	2.5 to 3.3	3.6 3.6	V
V _I	Input Voltage	0		5.5	V
V _O	Output Voltage (HIGH or LOW State)	0		V _{CC}	V
I _{OH}	HIGH Level Output Current V _{CC} = 3.0 V–3.6 V V _{CC} = 2.7 V–3.0 V V _{CC} = 2.3 V–2.7 V			-24 -12 -8	mA
I _{OL}	LOW Level Output Current V _{CC} = 3.0 V–3.6 V V _{CC} = 2.7 V–3.0 V V _{CC} = 2.3 V–2.7 V			+24 +12 +8	mA
T _A	Operating Free-Air Temperature	-40		+85	°C

DC ELECTRICAL CHARACTERISTICS

Symbol	Characteristic	Condition	T _A = -40 to 85°C		Units
			Min	Max	
V _{T+}	Positive Input Threshold Voltage (Figure 3)	V _{CC} = 2.5 V V _{CC} = 3.0 V	0.9 1.2	1.7 2.2	V
V _{T-}	Negative Input Threshold Voltage (Figure 3)	V _{CC} = 2.5 V V _{CC} = 3.0 V	0.4 0.6	1.1 1.5	V
V _H	Input Hysteresis Voltage (Figure 3)	V _{CC} = 2.5 V V _{CC} = 3.0 V	0.3 0.4	1.0 1.2	V
V _{OH}	HIGH Level Output Voltage	2.3 V ≤ V _{CC} ≤ 3.6 V; I _{OL} = 100 μA	V _{CC} - 0.2		V
		V _{CC} = 2.3 V; I _{OH} = -8 mA	1.8		
		V _{CC} = 2.7 V; I _{OH} = -12 mA	2.2		
		V _{CC} = 3.0 V; I _{OH} = -18 mA	2.4		
		V _{CC} = 3.0 V; I _{OH} = -24 mA	2.2		
V _{OL}	LOW Level Output Voltage	2.3 V ≤ V _{CC} ≤ 3.6 V; I _{OL} = 100 μA		0.2	V
		V _{CC} = 2.3 V; I _{OL} = 8 mA		0.3	
		V _{CC} = 2.7 V; I _{OL} = 12 mA		0.4	
		V _{CC} = 3.0 V; I _{OL} = 16 mA		0.4	
		V _{CC} = 3.0 V; I _{OL} = 24 mA		0.55	
I _{OFF}	Power Off Leakage Current	V _{CC} = 0, V _{IN} = 5.5 V or V _{OUT} = 5.5 V		10	μA
I _{IN}	Input Leakage Current	V _{CC} = 3.6 V, V _{IN} = 5.5 V or GND		±5.0	μA
I _{CC}	Quiescent Supply Current	V _{CC} = 3.6 V, V _{IN} = 5.5 V or GND		10	μA
ΔI _{CC}	Increase in I _{CC} per Input	2.3 ≤ V _{CC} ≤ 3.6 V; V _{IH} = V _{CC} - 0.6 V		500	μA

MC74LCX14

AC ELECTRICAL CHARACTERISTICS (Input $t_r = t_f = 2.5$ ns)

Symbol	Parameter	Waveform	Limits						Units
			$T_A = -40^\circ\text{C to } +85^\circ\text{C}$						
			$V_{CC} = 3.3 \text{ V} \pm 0.3 \text{ V}$		$V_{CC} = 2.7 \text{ V}$		$V_{CC} = 2.5 \text{ V} \pm 0.2 \text{ V}$		
			$C_L = 50 \text{ pF}$		$C_L = 50 \text{ pF}$		$C_L = 30 \text{ pF}$		
			Min	Max	Min	Max	Min	Max	
t_{PLH} t_{PHL}	Propagation Delay Input to Output	1	1.5 1.5	6.5 6.5	1.5 1.5	7.5 7.5	1.5 1.5	7.8 7.8	ns
t_{OSHL} t_{OSLH}	Output-to-Output Skew (Note 2)			1.0 1.0					ns

2. Skew is defined as the absolute value of the difference between the actual propagation delay for any two separate outputs of the same device. The specification applies to any outputs switching in the same direction, either HIGH-to-LOW (t_{OSHL}) or LOW-to-HIGH (t_{OSLH}); parameter guaranteed by design.

DYNAMIC SWITCHING CHARACTERISTICS

Symbol	Characteristic	Condition	$T_A = +25^\circ\text{C}$			Units
			Min	Typ	Max	
V_{OLP}	Dynamic LOW Peak Voltage (Note 3)	$V_{CC} = 3.3 \text{ V}, C_L = 50 \text{ pF}, V_{IH} = 3.3 \text{ V}, V_{IL} = 0 \text{ V}$ $V_{CC} = 2.5 \text{ V}, C_L = 30 \text{ pF}, V_{IH} = 2.5 \text{ V}, V_{IL} = 0 \text{ V}$		0.8 0.6		V
V_{OLV}	Dynamic LOW Valley Voltage (Note 3)	$V_{CC} = 3.3 \text{ V}, C_L = 50 \text{ pF}, V_{IH} = 3.3 \text{ V}, V_{IL} = 0 \text{ V}$ $V_{CC} = 2.5 \text{ V}, C_L = 30 \text{ pF}, V_{IH} = 2.5 \text{ V}, V_{IL} = 0 \text{ V}$		-0.8 -0.6		V

3. Number of outputs defined as "n". Measured with "n-1" outputs switching from HIGH-to-LOW or LOW-to-HIGH. The remaining output is measured in the LOW state.

CAPACITIVE CHARACTERISTICS

Symbol	Parameter	Condition	Typical	Units
C_{IN}	Input Capacitance	$V_{CC} = 3.3 \text{ V}, V_I = 0 \text{ V or } V_{CC}$	7	pF
C_{OUT}	Output Capacitance	$V_{CC} = 3.3 \text{ V}, V_I = 0 \text{ V or } V_{CC}$	8	pF
C_{PD}	Power Dissipation Capacitance	10 MHz, $V_{CC} = 3.3 \text{ V}, V_I = 0 \text{ V or } V_{CC}$	25	pF

ORDERING INFORMATION

Device	Package	Shipping [†]
MC74LCX14DG	SOIC-14 (Pb-Free)	55 Units / Rail
MC74LCX14DR2G	SOIC-14 (Pb-Free)	2500 Tape & Reel
MC74LCX14DTG	TSSOP-14 (Pb-Free)	96 Units / Rail
MC74LCX14DTR2G	TSSOP-14 (Pb-Free)	2500 Tape & Reel

[†]For information on tape and reel specifications, including part orientation and tape sizes, please refer to our Tape and Reel Packaging Specifications Brochure, BRD8011/D.

MC74LCX14

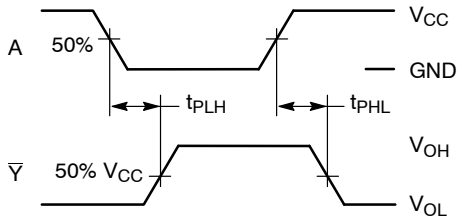
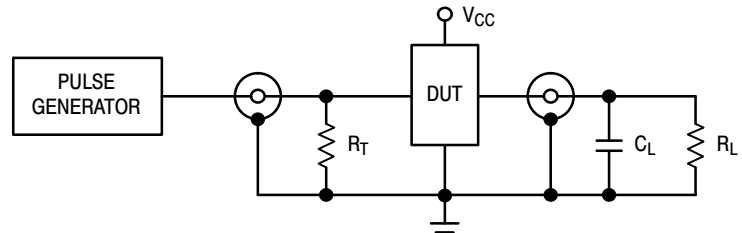

Figure 3. Switching Waveforms



$C_L = 50 \text{ pF}$ at $V_{CC} = 3.3 \pm 0.3 \text{ V}$ or equivalent (includes jig and probe capacitance)
 $R_L = R_1 = 500 \Omega$ or equivalent
 $R_T = Z_{OUT}$ of pulse generator (typically 50Ω)

Figure 4. Test Circuit

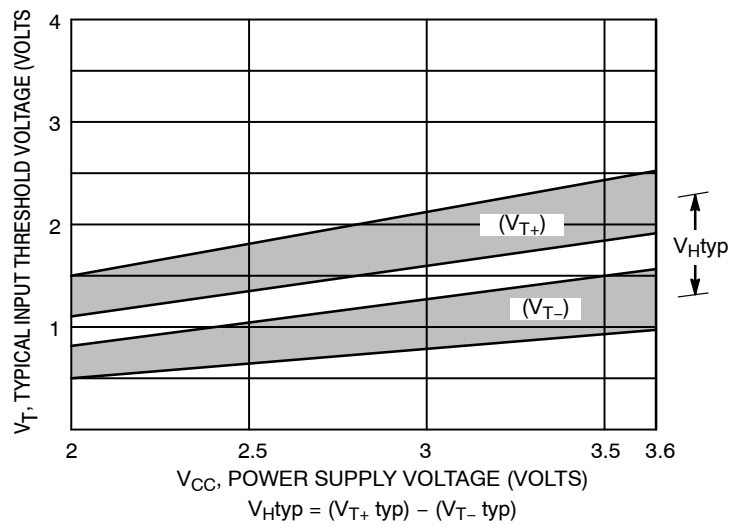
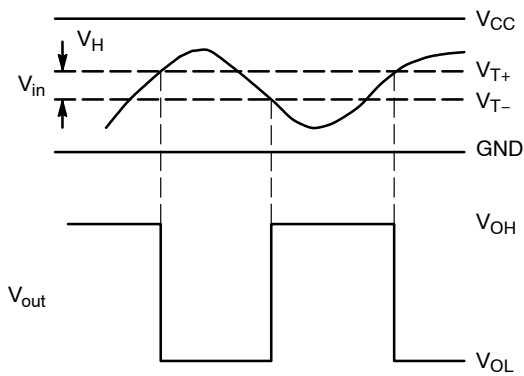

Figure 5. Typical Input Threshold, V_{T+} , V_{T-} versus Power Supply Voltage

(a) A Schmitt-Trigger Squares Up Inputs With Slow Rise and Fall Times



(b) A Schmitt-Trigger Offers Maximum Noise Immunity

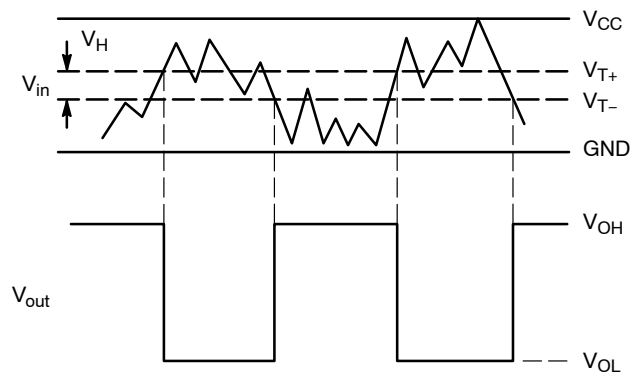

Figure 6. Typical Schmitt-Trigger Applications

MC74LCX14

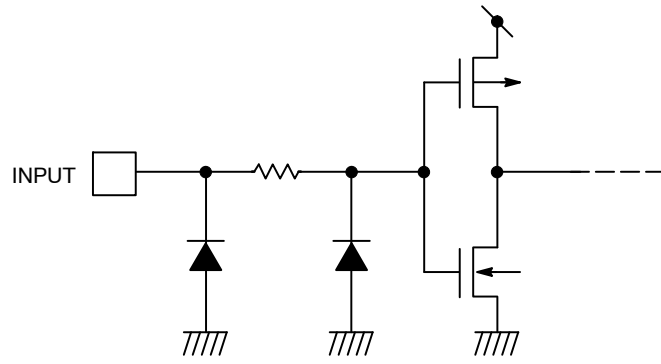
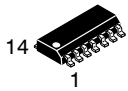

Figure 7. Input Equivalent Circuit

MECHANICAL CASE OUTLINE PACKAGE DIMENSIONS

ON Semiconductor®



SCALE 1:1

SOIC-14 NB
CASE 751A-03
ISSUE L

DATE 03 FEB 2016

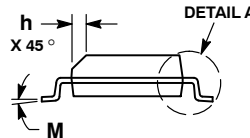
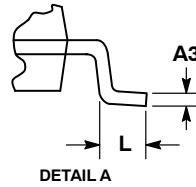
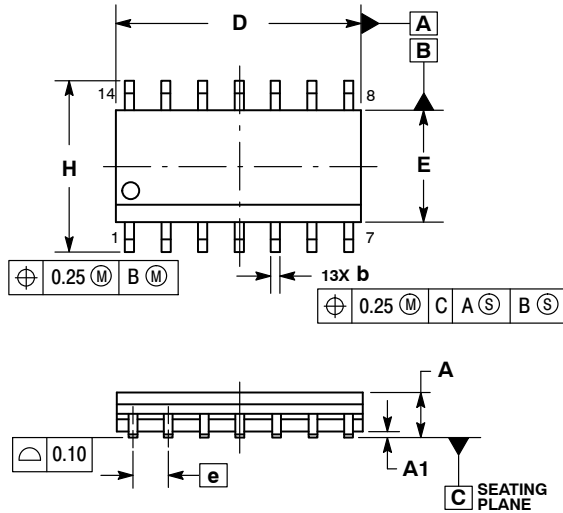

NOTES:

1. DIMENSIONING AND TOLERANCING PER ASME Y14.5M, 1994.
2. CONTROLLING DIMENSION: MILLIMETERS.
3. DIMENSION b DOES NOT INCLUDE DAMBAR PROTRUSION. ALLOWABLE PROTRUSION SHALL BE 0.13 TOTAL IN EXCESS OF AT MAXIMUM MATERIAL CONDITION.
4. DIMENSIONS D AND E DO NOT INCLUDE MOLD PROTRUSIONS.
5. MAXIMUM MOLD PROTRUSION 0.15 PER SIDE.

DIM	MILLIMETERS		INCHES	
	MIN	MAX	MIN	MAX
A	1.35	1.75	0.054	0.068
A1	0.10	0.25	0.004	0.010
A3	0.19	0.25	0.008	0.010
b	0.35	0.49	0.014	0.019
D	8.55	8.75	0.337	0.344
E	3.80	4.00	0.150	0.157
e	1.27 BSC		0.050 BSC	
H	5.80	6.20	0.228	0.244
h	0.25	0.50	0.010	0.019
L	0.40	1.25	0.016	0.049
M	0°	7°	0°	7°

SOLDERING FOOTPRINT*

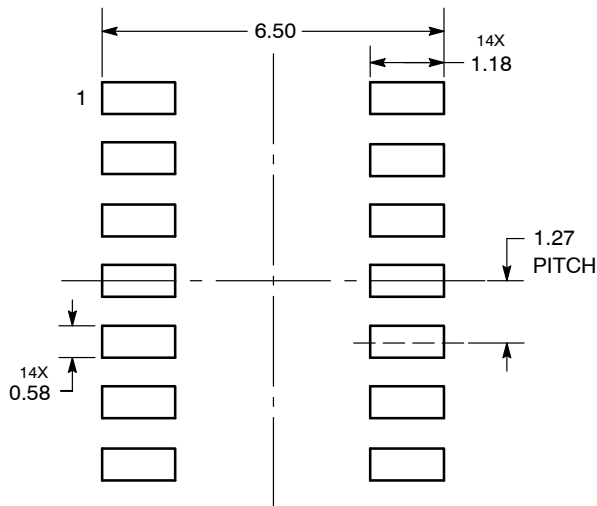

DIMENSIONS: MILLIMETERS

*For additional information on our Pb-Free strategy and soldering details, please download the ON Semiconductor Soldering and Mounting Techniques Reference Manual, SOLDERRM/D.

GENERIC MARKING DIAGRAM*

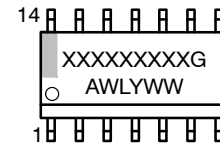

- XXXXXX = Specific Device Code
- A = Assembly Location
- WL = Wafer Lot
- Y = Year
- WW = Work Week
- G = Pb-Free Package

*This information is generic. Please refer to device data sheet for actual part marking. Pb-Free indicator, "G" or microdot "▪", may or may not be present.

STYLES ON PAGE 2

DOCUMENT NUMBER:	98ASB42565B	Electronic versions are uncontrolled except when accessed directly from the Document Repository. Printed versions are uncontrolled except when stamped "CONTROLLED COPY" in red.
DESCRIPTION:	SOIC-14 NB	PAGE 1 OF 2

ON Semiconductor and ON are trademarks of Semiconductor Components Industries, LLC dba ON Semiconductor or its subsidiaries in the United States and/or other countries. ON Semiconductor reserves the right to make changes without further notice to any products herein. ON Semiconductor makes no warranty, representation or guarantee regarding the suitability of its products for any particular purpose, nor does ON Semiconductor assume any liability arising out of the application or use of any product or circuit, and specifically disclaims any and all liability, including without limitation special, consequential or incidental damages. ON Semiconductor does not convey any license under its patent rights nor the rights of others.

SOIC-14
CASE 751A-03
ISSUE L

DATE 03 FEB 2016

STYLE 1:
 PIN 1. COMMON CATHODE
 2. ANODE/CATHODE
 3. ANODE/CATHODE
 4. NO CONNECTION
 5. ANODE/CATHODE
 6. NO CONNECTION
 7. ANODE/CATHODE
 8. ANODE/CATHODE
 9. ANODE/CATHODE
 10. NO CONNECTION
 11. ANODE/CATHODE
 12. ANODE/CATHODE
 13. NO CONNECTION
 14. COMMON ANODE

STYLE 2:
 CANCELLED

STYLE 3:
 PIN 1. NO CONNECTION
 2. ANODE
 3. ANODE
 4. NO CONNECTION
 5. ANODE
 6. NO CONNECTION
 7. ANODE
 8. ANODE
 9. ANODE
 10. NO CONNECTION
 11. ANODE
 12. ANODE
 13. NO CONNECTION
 14. COMMON CATHODE

STYLE 4:
 PIN 1. NO CONNECTION
 2. CATHODE
 3. CATHODE
 4. NO CONNECTION
 5. CATHODE
 6. NO CONNECTION
 7. CATHODE
 8. CATHODE
 9. CATHODE
 10. NO CONNECTION
 11. CATHODE
 12. CATHODE
 13. NO CONNECTION
 14. COMMON ANODE

STYLE 5:
 PIN 1. COMMON CATHODE
 2. ANODE/CATHODE
 3. ANODE/CATHODE
 4. ANODE/CATHODE
 5. ANODE/CATHODE
 6. NO CONNECTION
 7. COMMON ANODE
 8. COMMON CATHODE
 9. ANODE/CATHODE
 10. ANODE/CATHODE
 11. ANODE/CATHODE
 12. ANODE/CATHODE
 13. NO CONNECTION
 14. COMMON ANODE

STYLE 6:
 PIN 1. CATHODE
 2. CATHODE
 3. CATHODE
 4. CATHODE
 5. CATHODE
 6. CATHODE
 7. CATHODE
 8. ANODE
 9. ANODE
 10. ANODE
 11. ANODE
 12. ANODE
 13. ANODE
 14. ANODE

STYLE 7:
 PIN 1. ANODE/CATHODE
 2. COMMON ANODE
 3. COMMON CATHODE
 4. ANODE/CATHODE
 5. ANODE/CATHODE
 6. ANODE/CATHODE
 7. ANODE/CATHODE
 8. ANODE/CATHODE
 9. ANODE/CATHODE
 10. ANODE/CATHODE
 11. COMMON CATHODE
 12. COMMON ANODE
 13. ANODE/CATHODE
 14. ANODE/CATHODE

STYLE 8:
 PIN 1. COMMON CATHODE
 2. ANODE/CATHODE
 3. ANODE/CATHODE
 4. NO CONNECTION
 5. ANODE/CATHODE
 6. ANODE/CATHODE
 7. COMMON ANODE
 8. COMMON ANODE
 9. ANODE/CATHODE
 10. ANODE/CATHODE
 11. NO CONNECTION
 12. ANODE/CATHODE
 13. ANODE/CATHODE
 14. COMMON CATHODE

DOCUMENT NUMBER:	98ASB42565B	Electronic versions are uncontrolled except when accessed directly from the Document Repository. Printed versions are uncontrolled except when stamped "CONTROLLED COPY" in red.
DESCRIPTION:	SOIC-14 NB	PAGE 2 OF 2

ON Semiconductor and  are trademarks of Semiconductor Components Industries, LLC dba ON Semiconductor or its subsidiaries in the United States and/or other countries. ON Semiconductor reserves the right to make changes without further notice to any products herein. ON Semiconductor makes no warranty, representation or guarantee regarding the suitability of its products for any particular purpose, nor does ON Semiconductor assume any liability arising out of the application or use of any product or circuit, and specifically disclaims any and all liability, including without limitation special, consequential or incidental damages. ON Semiconductor does not convey any license under its patent rights nor the rights of others.

MECHANICAL CASE OUTLINE PACKAGE DIMENSIONS

ON Semiconductor®

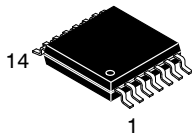

TSSOP-14 WB
CASE 948G
ISSUE C

DATE 17 FEB 2016

SCALE 2:1

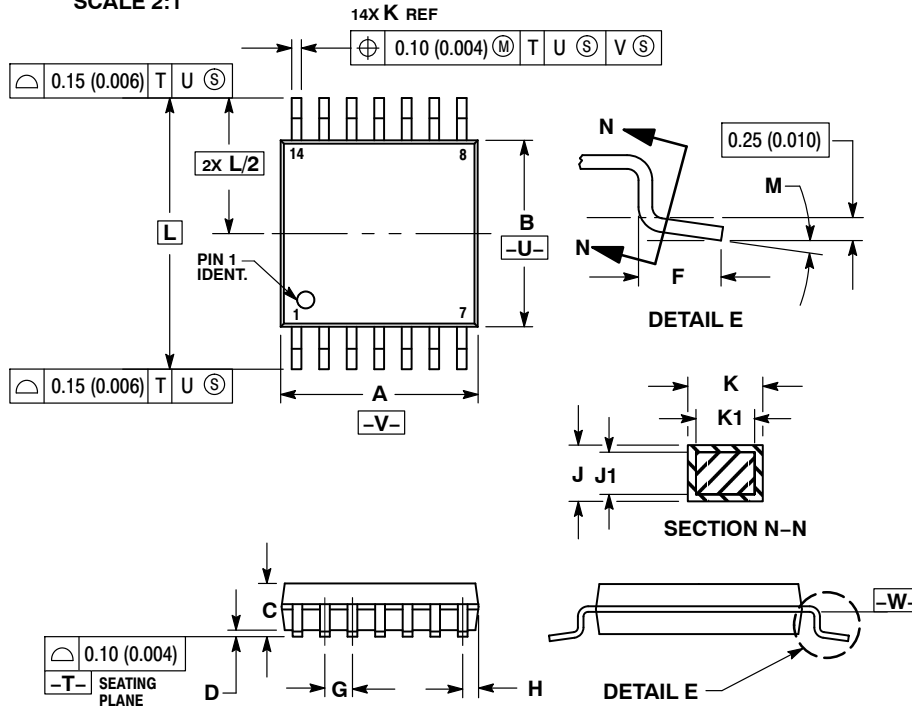

NOTES:

- DIMENSIONING AND TOLERANCING PER ANSI Y14.5M, 1982.
- CONTROLLING DIMENSION: MILLIMETER.
- DIMENSION A DOES NOT INCLUDE MOLD FLASH, PROTRUSIONS OR GATE BURRS. MOLD FLASH OR GATE BURRS SHALL NOT EXCEED 0.15 (0.006) PER SIDE.
- DIMENSION B DOES NOT INCLUDE INTERLEAD FLASH OR PROTRUSION. INTERLEAD FLASH OR PROTRUSION SHALL NOT EXCEED 0.25 (0.010) PER SIDE.
- DIMENSION K DOES NOT INCLUDE DAMBAR PROTRUSION. ALLOWABLE DAMBAR PROTRUSION SHALL BE 0.08 (0.003) TOTAL IN EXCESS OF THE K DIMENSION AT MAXIMUM MATERIAL CONDITION.
- TERMINAL NUMBERS ARE SHOWN FOR REFERENCE ONLY.
- DIMENSION A AND B ARE TO BE DETERMINED AT DATUM PLANE -W-.

DIM	MILLIMETERS		INCHES	
	MIN	MAX	MIN	MAX
A	4.90	5.10	0.193	0.200
B	4.30	4.50	0.169	0.177
C	---	1.20	---	0.047
D	0.05	0.15	0.002	0.006
F	0.50	0.75	0.020	0.030
G	0.65 BSC		0.026 BSC	
H	0.50	0.60	0.020	0.024
J	0.09	0.20	0.004	0.008
J1	0.09	0.16	0.004	0.006
K	0.19	0.30	0.007	0.012
K1	0.19	0.25	0.007	0.010
L	6.40 BSC		0.252 BSC	
M	0°	8°	0°	8°

GENERIC MARKING DIAGRAM*

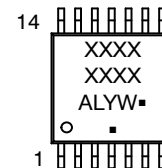

- A = Assembly Location
- L = Wafer Lot
- Y = Year
- W = Work Week
- = Pb-Free Package

(Note: Microdot may be in either location)

*This information is generic. Please refer to device data sheet for actual part marking. Pb-Free indicator, "G" or microdot "▪", may or may not be present.

SOLDERING FOOTPRINT

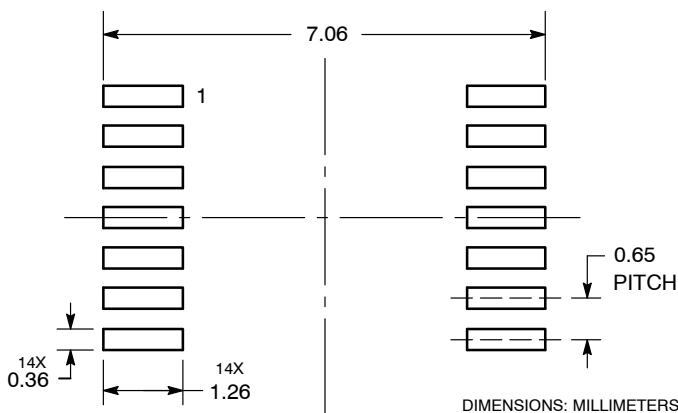

DOCUMENT NUMBER:	98ASH70246A	Electronic versions are uncontrolled except when accessed directly from the Document Repository. Printed versions are uncontrolled except when stamped "CONTROLLED COPY" in red.
DESCRIPTION:	TSSOP-14 WB	PAGE 1 OF 1

ON Semiconductor and ON are trademarks of Semiconductor Components Industries, LLC dba ON Semiconductor or its subsidiaries in the United States and/or other countries. ON Semiconductor reserves the right to make changes without further notice to any products herein. ON Semiconductor makes no warranty, representation or guarantee regarding the suitability of its products for any particular purpose, nor does ON Semiconductor assume any liability arising out of the application or use of any product or circuit, and specifically disclaims any and all liability, including without limitation special, consequential or incidental damages. ON Semiconductor does not convey any license under its patent rights nor the rights of others.

onsemi, **Onsemi**, and other names, marks, and brands are registered and/or common law trademarks of Semiconductor Components Industries, LLC dba "**onsemi**" or its affiliates and/or subsidiaries in the United States and/or other countries. **onsemi** owns the rights to a number of patents, trademarks, copyrights, trade secrets, and other intellectual property. A listing of **onsemi**'s product/patent coverage may be accessed at www.onsemi.com/site/pdf/Patent-Marking.pdf. **onsemi** reserves the right to make changes at any time to any products or information herein, without notice. The information herein is provided "as-is" and **onsemi** makes no warranty, representation or guarantee regarding the accuracy of the information, product features, availability, functionality, or suitability of its products for any particular purpose, nor does **onsemi** assume any liability arising out of the application or use of any product or circuit, and specifically disclaims any and all liability, including without limitation special, consequential or incidental damages. Buyer is responsible for its products and applications using **onsemi** products, including compliance with all laws, regulations and safety requirements or standards, regardless of any support or applications information provided by **onsemi**. "Typical" parameters which may be provided in **onsemi** data sheets and/or specifications can and do vary in different applications and actual performance may vary over time. All operating parameters, including "Typicals" must be validated for each customer application by customer's technical experts. **onsemi** does not convey any license under any of its intellectual property rights nor the rights of others. **onsemi** products are not designed, intended, or authorized for use as a critical component in life support systems or any FDA Class 3 medical devices or medical devices with a same or similar classification in a foreign jurisdiction or any devices intended for implantation in the human body. Should Buyer purchase or use **onsemi** products for any such unintended or unauthorized application, Buyer shall indemnify and hold **onsemi** and its officers, employees, subsidiaries, affiliates, and distributors harmless against all claims, costs, damages, and expenses, and reasonable attorney fees arising out of, directly or indirectly, any claim of personal injury or death associated with such unintended or unauthorized use, even if such claim alleges that **onsemi** was negligent regarding the design or manufacture of the part. **onsemi** is an Equal Opportunity/Affirmative Action Employer. This literature is subject to all applicable copyright laws and is not for resale in any manner.

PUBLICATION ORDERING INFORMATION

LITERATURE FULFILLMENT:

Email Requests to: orderlit@onsemi.com

onsemi Website: www.onsemi.com

TECHNICAL SUPPORT

North American Technical Support:

Voice Mail: 1 800-282-9855 Toll Free USA/Canada

Phone: 011 421 33 790 2910

Europe, Middle East and Africa Technical Support:

Phone: 00421 33 790 2910

For additional information, please contact your local Sales Representative