

1 Msps/500 kSPS, 14/12-Bit Differential Input SAR ADC

Features

- Sample Rate (Throughput):
 - MCP33151D/41D-10: 1 Msps
 - MCP33151D/41D-05: 500 kSPS
- 14/12-Bit Resolution with No Missing Codes
- No Latency Output
- Wide Operating Voltage Range:
 - Analog supply voltage (V_{DD}): 1.8V
 - Digital input/output interface voltage (DV_{IO}): 1.7-5.5V
 - External reference voltage (V_{REF}): $V_{DD} - 5.1V$
- Differential Input Operation
 - Input full-scale range: $-V_{REF}$ to $+V_{REF}$
- Ultra Low Current Consumption (typical):
 - During input acquisition (standby): $\sim 1.5 \mu A$
 - During conversion:
 - MCP33151D/41D-10: ~ 0.66 mA
 - MCP33151D/41D-05: ~ 0.33 mA
- SPI-Compatible Serial Communication:
 - SCLK clock rate: up to 100 MHz
 - 3-wire with optional BUSY indicator
- ADC Self-Calibration for Offset, Gain, and Linearity Errors:
 - During power-up (automatic)
 - On-Demand via user's command during normal operation
- Built In Data Accumulator
 - Integrate up to 1024 consecutive converted samples
 - Increase ENOB up to 18.5 bits by automatically averaging conversion results
- AEC-Q100 Qualified:
 - Temperature grade 1: $-40^{\circ}C$ to $+125^{\circ}C$
- Package Options: MSOP-10 and TDFN-10

Typical Applications

- High-Precision Data Acquisition
- Medical Instruments
- Test Equipment
- Electric Vehicle Battery Management Systems
- Motor Control Applications
- Switch-Mode Power Supply Applications
- Battery-Powered Equipment

System Design Supports

The MCP331x1D-XX Evaluation Kit demonstrates the performance of the MCP331x1D-XX SAR ADC family devices. The evaluation kit includes: (a) MCP331x1D Evaluation Board, (b) PIC32MZ EF Curiosity Board for data collection, and (c) SAR ADC Utility PC GUI.

Contact Microchip Technology Inc. for the evaluation tools and the PIC32 firmware example codes.

Package Types

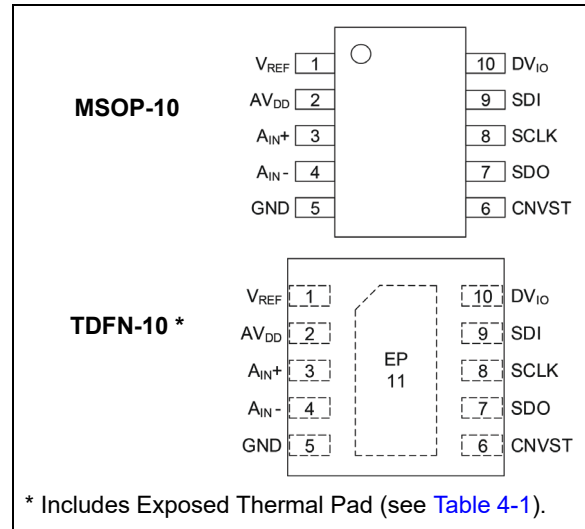

MCP331x1D-XX Device Offering (Note 1)

Part Number	Resolution	Sample Rate	Input Type	Input Range (Differential)	Performance (Typical)				
					SNR (dBFS)	SFDR (dB)	THD (dB)	INL (LSB)	DNL (LSB)
MCP33151D-10	14-bit	1 Msps	Differential	$\pm 5.1V$	83.8	107.3	-104.7	± 0.27	± 0.11
MCP33141D-10	12-bit	1 Msps	Differential	$\pm 5.1V$	73.8	100.0	-101.5	± 0.07	± 0.05
MCP33151D-05	14-bit	500 kSPS	Differential	$\pm 5.1V$	83.7	103.8	-100.9	± 0.27	± 0.11
MCP33141D-05	12-bit	500 kSPS	Differential	$\pm 5.1V$	73.8	99.8	-98.9	± 0.07	± 0.05

Note 1: SNR, SFDR, and THD are measured with $f_{IN} = 10$ kHz, $V_{IN} = -1$ dBFS, $V_{REF} = 5.1V$.

MCP33151D/41D-XX

Application Diagram

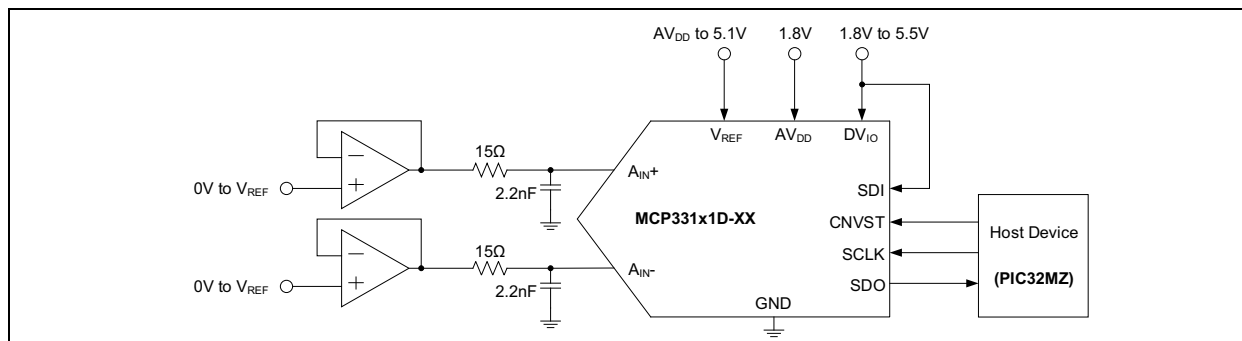

Description

The MCP33151D/41D-10 and MCP33151D/41D-05 are fully-differential, 14-bit and 12-bit, single-channel, 1 Msps and 500 kSPS ADC family devices, respectively, featuring low power consumption and high performance, using a successive approximation register (SAR) architecture.

The device operates with an external voltage reference (V_{REF}) from AV_{DD} to 5.1V, which supports a wide range of input full-scale range from $-V_{REF}$ to $+V_{REF}$. The reference voltage setting is independent of the analog supply voltage (AV_{DD}). The conversion output is available through an easy-to-use simple SPI-compatible 3-wire interface.

The device requires a 1.8V analog supply voltage (AV_{DD}) and a 1.7V to 5.5V digital I/O interface supply voltage (DV_{IO}). The wide digital I/O interface supply (DV_{IO}) range (1.7-5.5V) allows the device to interface with most host devices (Master) available in the current industry such as the PIC32 microcontrollers, without using external voltage level shifters.

Once all supply voltages are connected, the device will power-up and perform an automatic calibration to minimize offset, gain and linearity errors. The automatic calibration takes place approximately 40 ms following power-up, and it is necessary to ensure that all power supplies are fully settled and stable after this time. See [Section 4.3 “Power-Up Sequence and Auto-Calibration”](#) for more details. The device performance stays stable across the specified temperature range. However, when extreme changes in the operating environment, such as in the reference voltage, are made with respect to the initial conditions (e.g. the reference voltage did not fully settle during the initial power-up sequence), the user may send a recalibrate command anytime to initiate another self-calibration and restore optimum performance.

When the initial power-up sequence is completed, the device enters a low-current input acquisition mode (also referred to as ‘Standby mode’), where sampling capacitors are connected to the input pins.

During Standby, most of the internal analog circuitry is shutdown in order to reduce current consumption. Typically, the device consumes approximately 1.5 μ A during Standby. A new conversion is started on the rising edge of CNVST. When the conversion is complete and the host lowers CNVST, the output data is presented on SDO, and the device enters Standby to begin acquiring the next input sample. The user can clock out the ADC output data using the SPI-compatible serial clock during Standby.

The ADC system clock is generated by the internal on-chip clock, therefore the conversion is performed independent of the SPI serial clock (SCLK).

This device can be used for various high-speed and high-accuracy analog-to-digital data conversion applications, where design simplicity, low power, and no output latency are needed.

The device is AEC-Q100 qualified for automotive applications and operates over the extended temperature range of -40°C to $+125^{\circ}\text{C}$. The available package options are Pb-free small 3 mm \times 3 mm TDFN-10 and MSOP-10.

1.0 KEY ELECTRICAL CHARACTERISTICS

1.1 Absolute Maximum Ratings †

External Analog Supply Voltage (AV_{DD})	-0.3V to 2.0V
External Digital Supply Voltage (DV_{IO})	-0.3V to 5.8V
External Reference Voltage (V_{REF})	-0.3V to 5.8V
Analog Inputs w.r.t GND	-0.3V to $V_{REF} + 0.3V$
Current at Input Pins	± 2 mA
Current at Output and Supply Pins	± 250 mA
Storage Temperature	-65°C to +150°C
Maximum Junction Temperature (T_J)	+150°C
ESD Protection on All Pins	≤ 4 kV HBM, ≤ 2 kV CDM

† **Notice:** Stresses above those listed under “Absolute Maximum Ratings” may cause permanent damage to the device. This is a stress rating only and functional operation of the device at those or any other conditions above those indicated in the operational listings of this specification is not implied. Exposure to maximum rating conditions for extended periods may affect device reliability.

1.2 Electrical Specifications

TABLE 1-1: ELECTRICAL CHARACTERISTICS

<p>Electrical Specifications: Unless otherwise specified, all parameters apply for $T_A = -40^\circ\text{C}$ to $+125^\circ\text{C}$, $AV_{DD} = 1.8\text{V}$, $DV_{IO} = 3.3\text{V}$, $V_{REF} = 5\text{V}$, $GND = 0\text{V}$, Differential Analog Input (V_{IN}) = -1 dBFS sine wave, $f_{IN} = 10$ kHz, $C_{LOAD_SDO} = 20$ pF, $+25^\circ\text{C}$ is applied for typical values.</p> <p>MCP331x1D-10: Sample Rate (f_S) = 1 Msps, SPI Clock Input (SCLK) = 60 MHz.</p> <p>MCP331x1D-05: Sample Rate (f_S) = 500 kSPS, SPI Clock Input (SCLK) = 30 MHz.</p>						
Parameters	Sym.	Min.	Typ.	Max.	Units	Conditions
Power Supply Requirements						
Analog Supply Voltage Range	AV_{DD}	1.7	1.8	1.9	V	Note 3
Digital Input/Output Interface Voltage Range	DV_{IO}	1.7	—	5.5		Note 3
Analog Supply Current at AV_{DD} Pin:						
During Conversion	I_{DDAN}	—	660	900	μA	$f_S = 1$ Msps (MCP331x1D-10)
During Standby	I_{DDAN_STBY}	—	330	600	μA	$f_S = 500$ kSPS (MCP331x1D-05)
Average Digital Supply Current at DV_{IO} Pin:						
During Data Transfer	I_{IO_DATA}	—	400	—	μA	$f_S = 1$ Msps (MCP33151D-10)
		—	343	—	μA	$f_S = 1$ Msps (MCP33141D-10)
		—	200	—	μA	$f_S = 500$ kSPS (MCP33151D-05)
		—	171	—	μA	$f_S = 500$ kSPS (MCP33141D-05)
During Standby	I_{IO_STBY}	—	120	—	nA	During Input Acquisition (t_{ACQ})
External Reference Voltage Input						
Reference Voltage (Note 2, Note 3)	V_{REF}	AV_{DD}	—	5.1	V	

- Note 1:** This parameter is ensured by design and not 100% tested.
- 2:** This parameter is ensured by characterization and not 100% tested.
- 3:** Decoupling capacitor is recommended on the following pins:
 (a) AV_{DD} pin: 1 μF ceramic capacitor, (b) DV_{IO} pin: 0.1 μF ceramic capacitor,
 (c) V_{REF} pin: 10 μF tantalum capacitor.
- 4:** Differential Input Full-Scale Range (FSR) = $2 \times V_{REF}$.
- 5:** PSRR (dB) = $-20 \log(D_{VOUT}/AV_{DD})$, where D_{VOUT} = change in conversion result.
- 6:** ENOB = $(\text{SINAD} - 1.76)/6.02$.

MCP33151D/41D-XX

TABLE 1-1: ELECTRICAL CHARACTERISTICS (CONTINUED)

Electrical Specifications: Unless otherwise specified, all parameters apply for $T_A = -40^\circ\text{C}$ to $+125^\circ\text{C}$, $AV_{DD} = 1.8\text{V}$, $DV_{IO} = 3.3\text{V}$, $V_{REF} = 5\text{V}$, $GND = 0\text{V}$, Differential Analog Input (V_{IN}) = -1 dBFS sine wave, $f_{IN} = 10\text{ kHz}$, $C_{LOAD_SDO} = 20\text{ pF}$, $+25^\circ\text{C}$ is applied for typical values.
MCP331x1D-10: Sample Rate (f_S) = 1 Msps, SPI Clock Input (SCLK) = 60 MHz.
MCP331x1D-05: Sample Rate (f_S) = 500 kSPS, SPI Clock Input (SCLK) = 30 MHz.

Parameters	Sym.	Min.	Typ.	Max.	Units	Conditions
Reference Load Current at V_{REF} Pin:						
During Conversion	I_{REF}	—	220	290	μA	$f_S = 1\text{ Msps}$ (MCP331x1D-10)
During Standby	I_{REF_STBY}	—	110	180	μA	$f_S = 500\text{ kSPS}$ (MCP331x1D-05)
			40	—	nA	During Input Acquisition (t_{ACQ})
Total Power Consumption (Including AV_{DD}, DV_{IO}, V_{REF} pins)						
MCP331x1D-10						
at 1 Msps	P_{DISS_TOTAL}	—	3.6	—	mW	Averaged power for $t_{ACQ} + t_{CNV}$
at 500 kSPS		—	1.8	—	mW	
at 100 kSPS		—	0.4	—	mW	
During Standby	P_{DISS_STBY}	—	3.3	—	μW	Input acquisition (t_{ACQ})
MCP331x1D-05						
at 500 kSPS	P_{DISS_TOTAL}	—	1.8	—	mW	Averaged power for $t_{ACQ} + t_{CNV}$
at 100 kSPS		—	0.4	—	mW	
During Standby	P_{DISS_STBY}	—	3.3	—	μW	Input acquisition (t_{ACQ})
Analog Inputs						
Input Voltage Range (Note 2)	V_{IN+}	-0.1	—	$V_{REF} + 0.1$	V	Differential Input: $V_{IN} = V_{IN+} - V_{IN-}$
	V_{IN-}	-0.1	—	$V_{REF} + 0.1$		
Input Full-Scale Voltage Range	FSR	$-V_{REF}$	—	$+V_{REF}$	V_{PP}	Differential Input (Note 2, Note 4)
Input Common-mode Voltage Range	V_{CM}	0	$V_{REF}/2$	V_{REF}		Note 2
Input Sampling Capacitance	C_S	—	10	—	pF	Note 1
-3dB Input Bandwidth	BW_{-3dB}	—	45	—	MHz	Note 1
Aperture Delay (Note 1)		—	2.5	—	ns	Time delay between CNVST rising edge and when input is sampled
Leakage Current at Analog Input Pin	$I_{LEAK_AN_INPUT}$	—	± 2.2	± 200	nA	During Standby
System Performance						
Sample Rate (Throughput Rate)	f_S	—	—	1	Msps	MCP331x1D-10
		—	—	500	kSPS	MCP331x1D-05
Resolution (No Missing Codes)		14	—	—	bits	MCP33151D-XX
		12	—	—	bits	MCP33141D-XX
Integral Nonlinearity	INL	-1.5	± 0.27	+1.5	LSB	MCP33151D-XX
		—	± 0.07	—	LSB	MCP33141D-XX
Differential Nonlinearity	DNL	-0.8	± 0.11	+0.8	LSB	MCP33151D-XX
		-0.3	± 0.05	+0.3	LSB	MCP33141D-XX

Note 1: This parameter is ensured by design and not 100% tested.

Note 2: This parameter is ensured by characterization and not 100% tested.

Note 3: Decoupling capacitor is recommended on the following pins:

- (a) AV_{DD} pin: 1 μF ceramic capacitor, (b) DV_{IO} pin: 0.1 μF ceramic capacitor,
- (c) V_{REF} pin: 10 μF tantalum capacitor.

Note 4: Differential Input Full-Scale Range (FSR) = $2 \times V_{REF}$.

Note 5: PSRR (dB) = $-20 \log(D_{V_{OUT}}/AV_{DD})$, where $D_{V_{OUT}}$ = change in conversion result.

Note 6: ENOB = $(\text{SINAD} - 1.76)/6.02$.

MCP33151D/41D-XX

TABLE 1-1: ELECTRICAL CHARACTERISTICS (CONTINUED)

Electrical Specifications: Unless otherwise specified, all parameters apply for $T_A = -40^{\circ}\text{C}$ to $+125^{\circ}\text{C}$, $AV_{DD} = 1.8\text{V}$, $DV_{IO} = 3.3\text{V}$, $V_{REF} = 5\text{V}$, $GND = 0\text{V}$, Differential Analog Input (V_{IN}) = -1 dBFS sine wave, $f_{IN} = 10\text{kHz}$, $C_{LOAD_SDO} = 20\text{pF}$, $+25^{\circ}\text{C}$ is applied for typical values.
MCP331x1D-10: Sample Rate (f_S) = 1 Msps, SPI Clock Input (SCLK) = 60 MHz.
MCP331x1D-05: Sample Rate (f_S) = 500 kSPS, SPI Clock Input (SCLK) = 30 MHz.

Parameters	Sym.	Min.	Typ.	Max.	Units	Conditions		
Offset Error		-1.62	± 0.4	1.62	mV	MCP33151D-XX		
		-1.33	± 0.4	1.33	mV	MCP33141D-XX		
Offset Error Drift with Temperature		—	± 0.1	—	$\mu\text{V}/^{\circ}\text{C}$	—		
Gain Error	G_{ER}	—	± 1	—	LSB	MCP33151D-XX		
		—	± 0.2	—	LSB	MCP33141D-XX		
Gain Error Drift with Temperature		—	± 8	—	$\mu\text{V}/^{\circ}\text{C}$	—		
Input Common-mode Rejection Ratio	CMRR	—	84	—	dB	—		
Power Supply Rejection Ratio	PSRR	—	75	—	dB	Note 5		
Dynamic Performance								
Signal-to-Noise Ratio	SNR	MCP33151D-10 and MCP33151D-05: 14-bit ADC						
		—	83.9	—	dBFS	$V_{REF} = 5\text{V}$, $f_{IN} = 1\text{kHz}$		
		—	79.2	—		$V_{REF} = 1.8\text{V}$, $f_{IN} = 1\text{kHz}$		
		82.6	83.7	—		$V_{REF} = 5\text{V}$, $f_{IN} = 10\text{kHz}$		
		—	78.8	—		$V_{REF} = 1.8\text{V}$, $f_{IN} = 10\text{kHz}$		
		MCP33141D-10 and MCP33141D-05: 12-bit ADC						
		—	73.8	—	dBFS	$V_{REF} = 5\text{V}$, $f_{IN} = 1\text{kHz}$		
		—	73.1	—		$V_{REF} = 1.8\text{V}$, $f_{IN} = 1\text{kHz}$		
		73.4	73.8	—		$V_{REF} = 5\text{V}$, $f_{IN} = 10\text{kHz}$		
		—	73.0	—		$V_{REF} = 1.8\text{V}$, $f_{IN} = 10\text{kHz}$		
		Signal-to-Noise Distortion Ratio (Note 6)	SINAD	MCP33151D-10 and MCP33151D-05: 14-bit ADC				
				—	83.9	—	dBFS	$V_{REF} = 5\text{V}$, $f_{IN} = 1\text{kHz}$
—	79.2			—	$V_{REF} = 1.8\text{V}$, $f_{IN} = 1\text{kHz}$			
—	83.6			—	$V_{REF} = 5\text{V}$, $f_{IN} = 10\text{kHz}$			
—	77.8			—	$V_{REF} = 1.8\text{V}$, $f_{IN} = 10\text{kHz}$			
MCP33141D-10 and MCP33141D-05: 12-bit ADC								
—	73.8			—	dBFS	$V_{REF} = 5\text{V}$, $f_{IN} = 1\text{kHz}$		
—	73.1			—		$V_{REF} = 1.8\text{V}$, $f_{IN} = 1\text{kHz}$		
—	73.8			—		$V_{REF} = 5\text{V}$, $f_{IN} = 10\text{kHz}$		
—	73.0			—		$V_{REF} = 1.8\text{V}$, $f_{IN} = 10\text{kHz}$		

- Note 1:** This parameter is ensured by design and not 100% tested.
Note 2: This parameter is ensured by characterization and not 100% tested.
Note 3: Decoupling capacitor is recommended on the following pins:
(a) AV_{DD} pin: 1 μF ceramic capacitor, (b) DV_{IO} pin: 0.1 μF ceramic capacitor,
(c) V_{REF} pin: 10 μF tantalum capacitor.
Note 4: Differential Input Full-Scale Range (FSR) = $2 \times V_{REF}$.
Note 5: PSRR (dB) = $-20 \log(D_{VOUT}/AV_{DD})$, where D_{VOUT} = change in conversion result.
Note 6: ENOB = $(\text{SINAD} - 1.76)/6.02$.

MCP33151D/41D-XX

TABLE 1-1: ELECTRICAL CHARACTERISTICS (CONTINUED)

Electrical Specifications: Unless otherwise specified, all parameters apply for $T_A = -40^{\circ}\text{C}$ to $+125^{\circ}\text{C}$, $AV_{DD} = 1.8\text{V}$, $DV_{IO} = 3.3\text{V}$, $V_{REF} = 5\text{V}$, $\text{GND} = 0\text{V}$, Differential Analog Input (V_{IN}) = -1 dBFS sine wave, $f_{IN} = 10\text{ kHz}$, $C_{LOAD_SDO} = 20\text{ pF}$, $+25^{\circ}\text{C}$ is applied for typical values.
MCP331x1D-10: Sample Rate (f_S) = 1 Msps, SPI Clock Input (SCLK) = 60 MHz.
MCP331x1D-05: Sample Rate (f_S) = 500 kSPS, SPI Clock Input (SCLK) = 30 MHz.

Parameters	Sym.	Min.	Typ.	Max.	Units	Conditions		
Spurious Free Dynamic Range	SFDR	MCP33151D-10 and MCP33151D-05: 14-bit ADC						
		—	110.5	—	dBc	$V_{REF} = 5\text{V}$, $f_{IN} = 1\text{ kHz}$		
		—	107.2	—		$V_{REF} = 1.8\text{V}$, $f_{IN} = 1\text{ kHz}$		
		—	105.9	—		$V_{REF} = 5\text{V}$, $f_{IN} = 10\text{ kHz}$		
		—	96.3	—		$V_{REF} = 1.8\text{V}$, $f_{IN} = 10\text{ kHz}$		
		MCP33141D-10 and MCP33141D-05: 12-bit ADC						
		—	99.8	—	dBc	$V_{REF} = 5\text{V}$, $f_{IN} = 1\text{ kHz}$		
		—	99.4	—		$V_{REF} = 1.8\text{V}$, $f_{IN} = 1\text{ kHz}$		
		—	99.9	—		$V_{REF} = 5\text{V}$, $f_{IN} = 10\text{ kHz}$		
		—	95.2	—		$V_{REF} = 1.8\text{V}$, $f_{IN} = 10\text{ kHz}$		
		Total Harmonic Distortion (first five harmonics)	THD	MCP33151D-10 and MCP33151D-05: 14-bit ADC				
				—	-105.0	—	dBc	$V_{REF} = 5\text{V}$, $f_{IN} = 1\text{ kHz}$
—	-105.2			—	$V_{REF} = 1.8\text{V}$, $f_{IN} = 1\text{ kHz}$			
—	103.2			—	$V_{REF} = 5\text{V}$, $f_{IN} = 10\text{ kHz}$			
—	95.2			—	$V_{REF} = 1.8\text{V}$, $f_{IN} = 10\text{ kHz}$			
MCP33141D-10 and MCP33141D-05: 12-bit ADC								
—	-100.7			—	dBc	$V_{REF} = 5\text{V}$, $f_{IN} = 1\text{ kHz}$		
—	-100.3			—		$V_{REF} = 1.8\text{V}$, $f_{IN} = 1\text{ kHz}$		
—	-100.4			—		$V_{REF} = 5\text{V}$, $f_{IN} = 10\text{ kHz}$		
—	-94.2			—		$V_{REF} = 1.8\text{V}$, $f_{IN} = 10\text{ kHz}$		
System Self-Calibration								
Self-Calibration Time	t_{CAL}			—	400	550	ms	Note 2
Number of SCLK Clocks for Recalibrate Command	ReCal_{NSCLK}	—	1024	—	clocks	Includes clocks for data bits		
Serial Interface Timing Information: See Serial Interface Timing Specifications								
Digital Inputs/Outputs								
High-level Input Voltage	V_{IH}	$0.7 \times D$	—	$DV_{IO} + 0.3$	V	$DV_{IO} \geq 2.3\text{V}$		
		V_{IO}				$DV_{IO} < 2.3\text{V}$		
Low-level Input Voltage	V_{IL}	-0.3	—	$0.3 \times DV_{IO}$	V	$DV_{IO} \geq 2.3\text{V}$		
		-0.3		$0.2 \times DV_{IO}$		$DV_{IO} < 2.3\text{V}$		
Hysteresis of Schmitt Trigger Inputs	V_{HYST}	—	$0.2 \times DV_{IO}$	—	V	All digital inputs		

- Note 1:** This parameter is ensured by design and not 100% tested.
Note 2: This parameter is ensured by characterization and not 100% tested.
3: Decoupling capacitor is recommended on the following pins:
(a) AV_{DD} pin: 1 μF ceramic capacitor, (b) DV_{IO} pin: 0.1 μF ceramic capacitor,
(c) V_{REF} pin: 10 μF tantalum capacitor.
4: Differential Input Full-Scale Range (FSR) = $2 \times V_{REF}$.
5: PSRR (dB) = $-20 \log(DV_{OUT}/AV_{DD})$, where DV_{OUT} = change in conversion result.
6: ENOB = $(\text{SINAD} - 1.76)/6.02$.

MCP33151D/41D-XX

TABLE 1-1: ELECTRICAL CHARACTERISTICS (CONTINUED)

Electrical Specifications: Unless otherwise specified, all parameters apply for $T_A = -40^\circ\text{C}$ to $+125^\circ\text{C}$, $AV_{DD} = 1.8\text{V}$, $DV_{IO} = 3.3\text{V}$, $V_{REF} = 5\text{V}$, $\text{GND} = 0\text{V}$, Differential Analog Input (V_{IN}) = -1 dBFS sine wave, $f_{IN} = 10\text{ kHz}$, $C_{LOAD_SDO} = 20\text{ pF}$, $+25^\circ\text{C}$ is applied for typical values.
MCP331x1D-10: Sample Rate (f_S) = 1 Msps, SPI Clock Input (SCLK) = 60 MHz.
MCP331x1D-05: Sample Rate (f_S) = 500 kSPS, SPI Clock Input (SCLK) = 30 MHz.

Parameters	Sym.	Min.	Typ.	Max.	Units	Conditions
Low-level Output Voltage	V_{OL}	—	—	$0.2 \times DV_{IO}$	V	$I_{OL} = 500\ \mu\text{A}$ (source)
High-level Output Voltage	V_{OH}	$0.8 \times D$ V_{IO}	—	—	V	$I_{OH} = -500\ \mu\text{A}$ (sink)
Input Leakage Current	I_{LI}	—	—	± 1	μA	CNVST/SDI/SCLK = GND or DV_{IO}
Output Leakage Current	I_{LO}	—	—	± 1	μA	Output is high-Z, SDO = GND or DV_{IO}
Internal Capacitance (all digital inputs and outputs)	C_{INT}	—	7	—	pF	$T_A = +25^\circ\text{C}$

- Note 1:** This parameter is ensured by design and not 100% tested.
Note 2: This parameter is ensured by characterization and not 100% tested.
Note 3: Decoupling capacitor is recommended on the following pins:
(a) AV_{DD} pin: 1 μF ceramic capacitor, (b) DV_{IO} pin: 0.1 μF ceramic capacitor,
(c) V_{REF} pin: 10 μF tantalum capacitor.
Note 4: Differential Input Full-Scale Range (FSR) = $2 \times V_{REF}$.
Note 5: PSRR (dB) = $-20 \log(D_{VOUT}/AV_{DD})$, where D_{VOUT} = change in conversion result.
Note 6: ENOB = $(\text{SINAD} - 1.76)/6.02$.

TABLE 1-2: SERIAL INTERFACE TIMING SPECIFICATIONS

Electrical Specifications: Unless otherwise specified, all parameters apply for $T_A = -40^\circ\text{C}$ to $+125^\circ\text{C}$, $AV_{DD} = 1.8\text{V}$, $DV_{IO} = 3.3\text{V}$, $\text{GND} = 0\text{V}$, Differential Analog Input (A_{IN}) = -1 dBFS sine wave, Resolution = 14-bit (MCP33151D-10), $f_{IN} = 10\text{ kHz}$, Sample Rate (f_S) = 1 Msps, $+25^\circ\text{C}$ is applied for typical values. All timings are measured at 50%. See [Figure 1-1](#) for timing diagram.

Parameters	Sym.	Min.	Typ.	Max.	Units	Conditions
Serial Clock Frequency	f_{SCLK}	—	—	100	MHz	See t_{SCLK} specification
SCLK Period	t_{SCLK}	10	—	—	ns	$D_{VIO} \geq 3.3\text{V}$, $f_{SCLK} = 100\text{ MHz}$ (Max.)
		12	—	—		$D_{VIO} \geq 2.3\text{V}$, $f_{SCLK} = 83.3\text{ MHz}$ (Max.)
		16	—	—		$D_{VIO} \geq 1.7\text{V}$, $f_{SCLK} = 62.5\text{ MHz}$ (Max.)
SCLK Low Time	t_{SCLK_L}	3	—	—	ns	$D_{VIO} \geq 2.3\text{V}$
		4.5	—	—		$D_{VIO} \geq 1.7\text{V}$
SCLK High Time	t_{SCLK_H}	3	—	—	ns	$D_{VIO} \geq 2.3\text{V}$
		4.5	—	—		$D_{VIO} \geq 1.7\text{V}$
Output Valid from SCLK Low	t_{DO}	—	—	10	ns	$D_{VIO} \geq 3.3\text{V}$
		—	—	12		$D_{VIO} \geq 2.3\text{V}$
		—	—	16		$D_{VIO} \geq 1.7\text{V}$
Quiet Time	t_{QUIET}	10	—	—	ns	—

3-wire Operation:

- Note 1:** This parameter is ensured by design and not 100% tested.
Note 2: This parameter is ensured by characterization and not 100% tested.

MCP33151D/41D-XX

TABLE 1-2: SERIAL INTERFACE TIMING SPECIFICATIONS (CONTINUED)

Electrical Specifications: Unless otherwise specified, all parameters apply for $T_A = -40^{\circ}\text{C}$ to $+125^{\circ}\text{C}$, $AV_{DD} = 1.8\text{V}$, $DV_{IO} = 3.3\text{V}$, $\text{GND} = 0\text{V}$,
 Differential Analog Input (A_{IN}) = -1 dBFS sine wave, Resolution = 14-bit (MCP33151D-10), $f_{IN} = 10\text{ kHz}$, Sample Rate (f_S) = 1 Msp/s, $+25^{\circ}\text{C}$ is applied for typical values. All timings are measured at 50%. See [Figure 1-1](#) for timing diagram.

Parameters	Sym.	Min.	Typ.	Max.	Units	Conditions
SDI Valid Setup Time	$t_{SU_SDIH_CNV}$	5	—	—	ns	SDI High to CNVST Rising Edge
CNVST Pulse Width Time	t_{CNVH}	10	—	—	—	—
Output Enable Time	t_{EN}	—	—	10	—	$D_{VIO} \geq 2.3\text{V}$
		—	—	15		$D_{VIO} \geq 1.7\text{V}$
Output Disable Time	t_{DIS}	—	—	15	—	Note 2
MCP331x1D-10						
Sample Rate	f_S	—	—	1	Msp/s	Throughput Rate
Input Acquisition Time	t_{ACQ}	250	490	—	ns	—
Data Conversion Time	t_{CNV}	—	510	750	ns	—
Time Between Conversions	t_{CYC}	1	—	—	μs	$t_{CYC} = t_{ACQ} + t_{CNV}$, $f_S = 1\text{ Msp/s}$
MCP331x1D-05						
Sample Rate	f_S	—	—	500	kSPS	Throughput Rate
Input Acquisition Time	t_{ACQ}	600	800	—	ns	—
Data Conversion Time	t_{CNV}	—	1200	1400	ns	—
Time Between Conversions	t_{CYC}	2	—	—	μs	$t_{CYC} = t_{ACQ} + t_{CNV}$, $f_S = 500\text{ kSPS}$

- Note 1:** This parameter is ensured by design and not 100% tested.
Note 2: This parameter is ensured by characterization and not 100% tested.

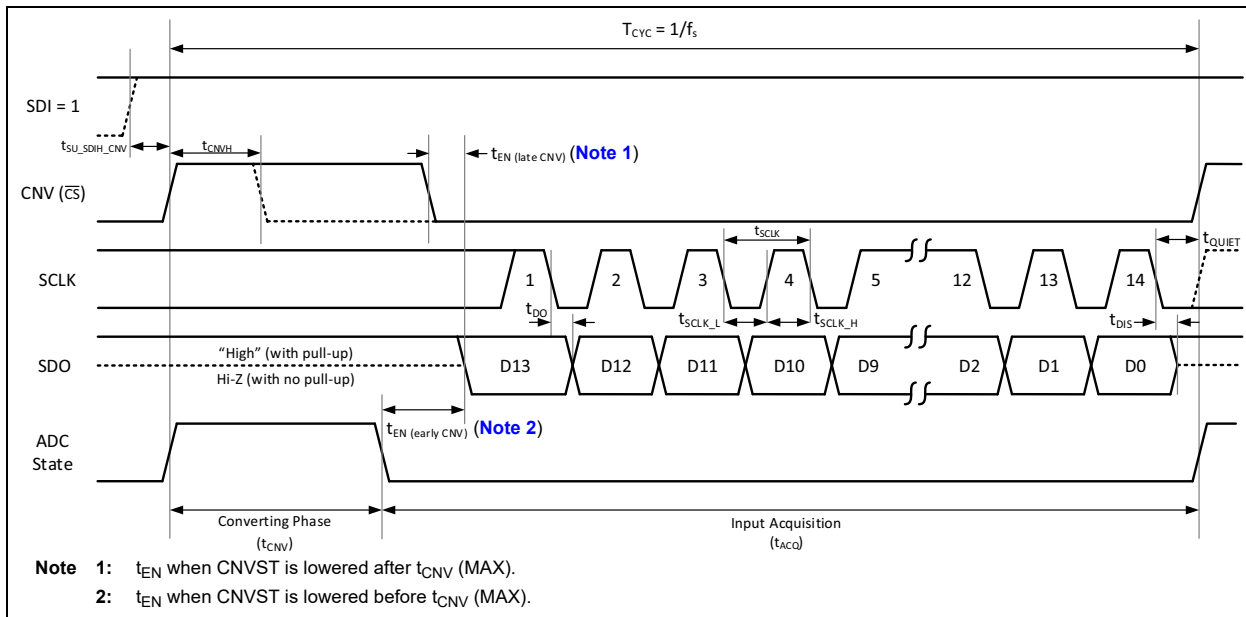

FIGURE 1-1: Interface Timing Diagram (14-bit device). CNVST is Used as Chip Select. See Section 6.0 “Digital Serial Interface” for More Details.

MCP33151D/41D-XX

TABLE 1-3: TEMPERATURE CHARACTERISTICS

Parameters	Symbol	Min.	Typ.	Max.	Units	Conditions
Temperature Ranges						
Operating Temperature Range	T_A	-40	—	+125	°C	Note 1
Storage Temperature Range	T_A	-65	—	+150	°C	Note 1
Thermal Package Resistance						
Thermal Resistance, MSOP-10	θ_{JA}	—	202	—	°C/W	—
Thermal Resistance, TDFN-10	θ_{JA}	—	68	—	°C/W	—

Note 1: The internal junction temperature (T_j) must not exceed the absolute maximum specification of +150°C.

MCP33151D/41D-XX

NOTES:

2.0 TYPICAL PERFORMANCE CURVES FOR 14-BIT DEVICES (MCP33151D-XX)

Note: The graphs and tables provided following this note are a statistical summary based on a limited number of samples and are provided for informational purposes only. The performance characteristics listed herein are not tested or guaranteed. In some graphs or tables, the data presented may be outside the specified operating range (e.g., outside specified power supply range) and therefore outside the warranted range.

Note: Unless otherwise specified, all parameters apply for $T_A = +25^\circ\text{C}$, $AV_{DD} = 1.8\text{V}$, $DV_{IO} = 3.3\text{V}$, $V_{REF} = 5\text{V}$, $GND = 0\text{V}$, Differential Analog Input (V_{IN}) = -1 dBFS, $f_{IN} = 10\text{ kHz}$, $C_{LOAD_SDO} = 20\text{ pF}$.
MCP33151D-10: Sample Rate (f_S) = 1 Msps, SPI Clock Input = 60 MHz.
MCP33151D-05: Sample Rate (f_S) = 500 kSPS, SPI Clock Input = 30 MHz.

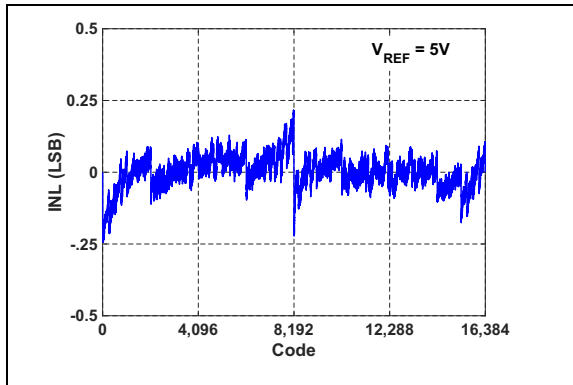

FIGURE 2-1: INL vs. Output Code:
 $V_{REF} = 5\text{V}$.

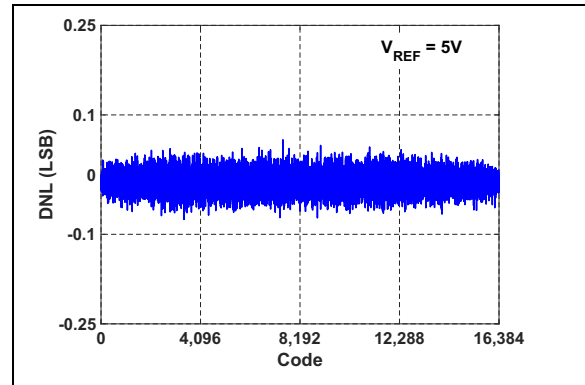

FIGURE 2-4: DNL vs. Output Code:
 $V_{REF} = 5\text{V}$.

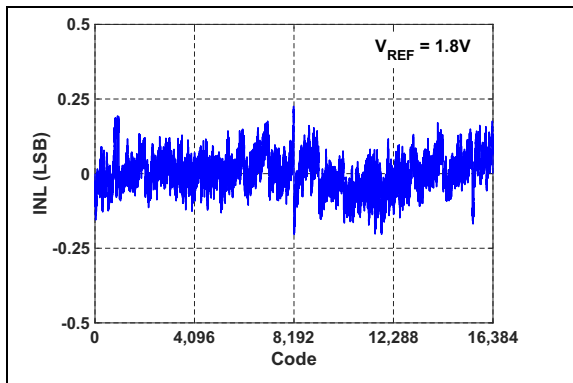

FIGURE 2-2: INL vs. Output Code:
 $V_{REF} = 1.8\text{V}$.

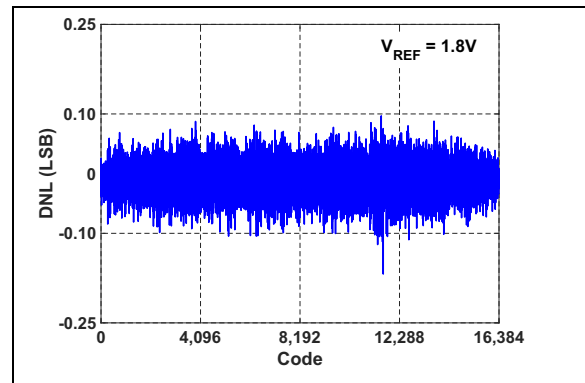

FIGURE 2-5: DNL vs. Output Code:
 $V_{REF} = 1.8\text{V}$.

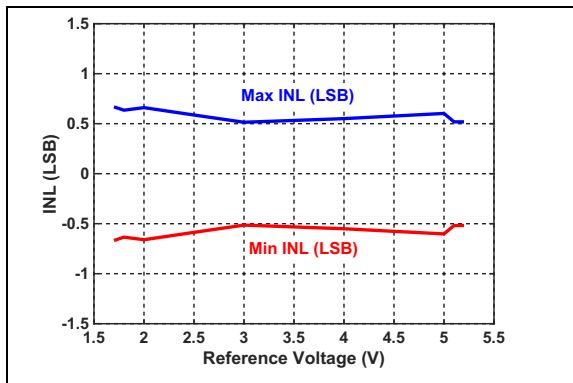

FIGURE 2-3: INL vs. Reference Voltage.

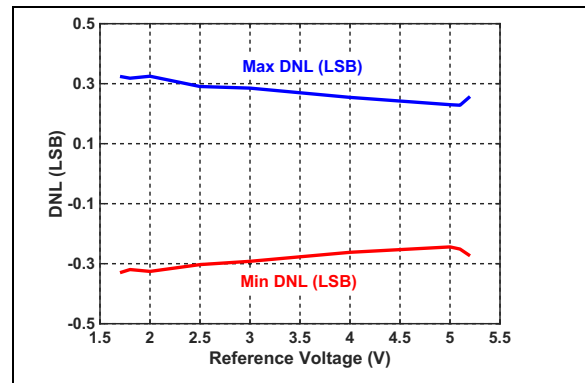

FIGURE 2-6: DNL vs. Reference Voltage.

MCP33151D/41D-XX

Note: Unless otherwise specified, all parameters apply for $T_A = +25^\circ\text{C}$, $AV_{DD} = 1.8\text{V}$, $DV_{IO} = 3.3\text{V}$, $V_{REF} = 5\text{V}$, $GND = 0\text{V}$, Differential Analog Input (V_{IN}) = -1 dBFS , $f_{IN} = 10\text{ kHz}$, $C_{LOAD_SDO} = 20\text{ pF}$.
MCP33151D-10: Sample Rate (f_S) = 1 Msp s, SPI Clock Input = 60 MHz .
MCP33151D-05: Sample Rate (f_S) = 500 kSPS , SPI Clock Input = 30 MHz .

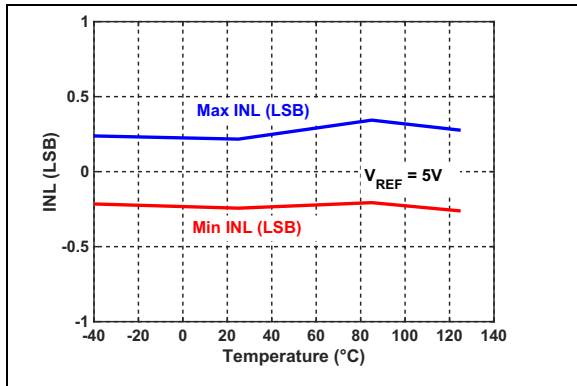

FIGURE 2-7: INL vs. Temperature.

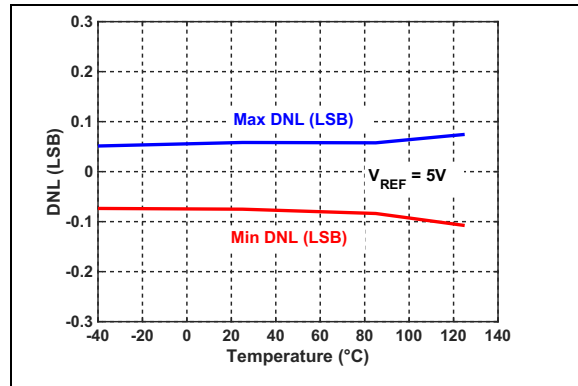

FIGURE 2-10: DNL vs. Temperature.

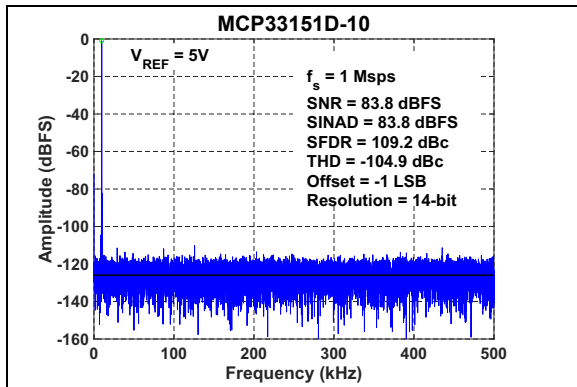

FIGURE 2-8: FFT for 10 kHz Input Signal: $f_S = 1\text{ Msp}$ s, $V_{IN} = -1\text{ dBFS}$, $V_{REF} = 5\text{V}$.

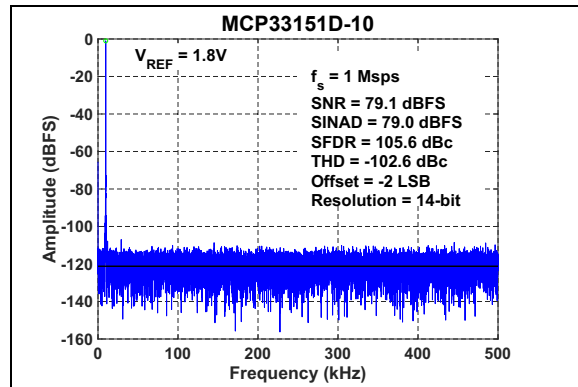

FIGURE 2-11: FFT for 10 kHz Input Signal: $f_S = 1\text{ Msp}$ s, $V_{IN} = -1\text{ dBFS}$, $V_{REF} = 1.8\text{V}$.

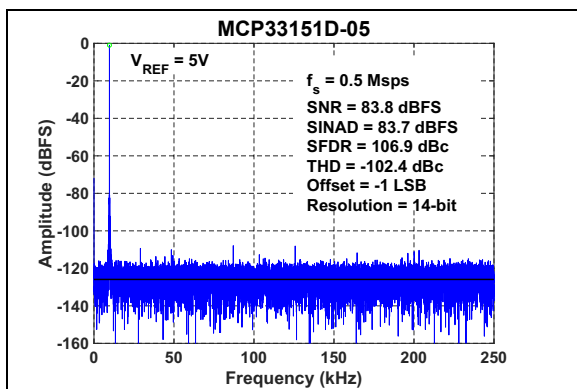

FIGURE 2-9: FFT for 10 kHz Input Signal: $f_S = 500\text{ kSPS}$, $V_{IN} = -1\text{ dBFS}$, $V_{REF} = 5\text{V}$.

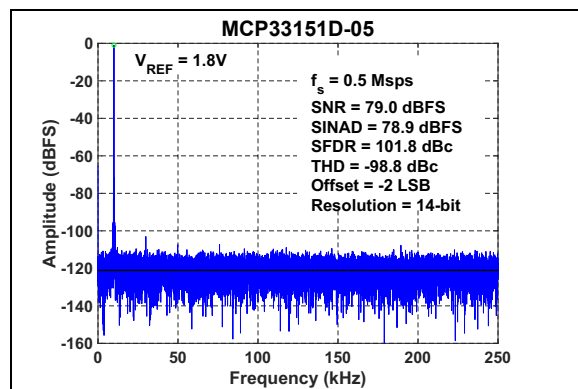

FIGURE 2-12: FFT for 10 kHz Input Signal: $f_S = 500\text{ kSPS}$, $V_{IN} = -1\text{ dBFS}$, $V_{REF} = 1.8\text{V}$.

MCP33151D/41D-XX

Note: Unless otherwise specified, all parameters apply for $T_A = +25^\circ\text{C}$, $AV_{DD} = 1.8\text{V}$, $DV_{IO} = 3.3\text{V}$, $V_{REF} = 5\text{V}$, $GND = 0\text{V}$, Differential Analog Input (V_{IN}) = -1 dBFS, $f_{IN} = 10\text{ kHz}$, $C_{LOAD_SDO} = 20\text{ pF}$.
MCP33151D-10: Sample Rate (f_S) = 1 Msps, SPI Clock Input = 60 MHz.
MCP33151D-05: Sample Rate (f_S) = 500 kSPS, SPI Clock Input = 30 MHz.

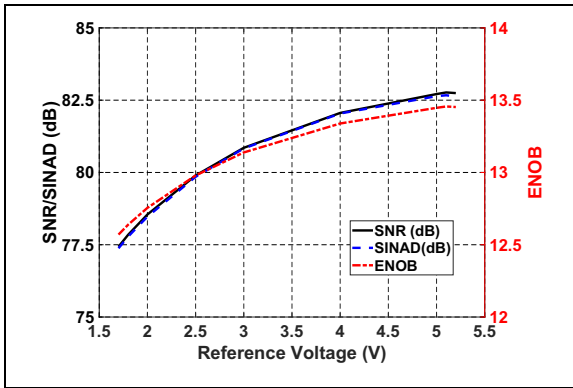

FIGURE 2-13: SNR/SINAD/ENOB vs. Reference Voltage.

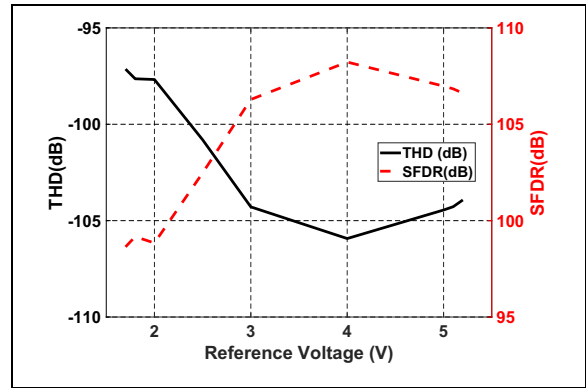

FIGURE 2-16: THD/SFDR vs. Reference Voltage.

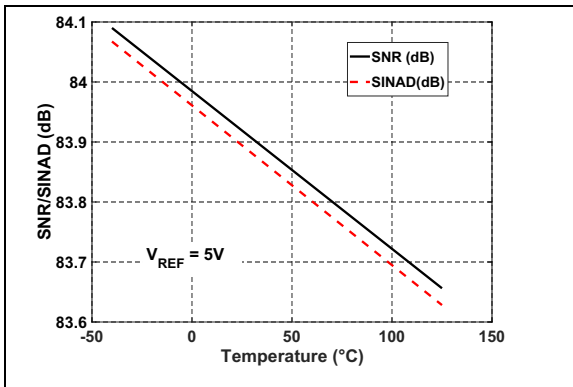

FIGURE 2-14: SNR/SINAD vs. Temperature: $V_{REF} = 5\text{V}$.

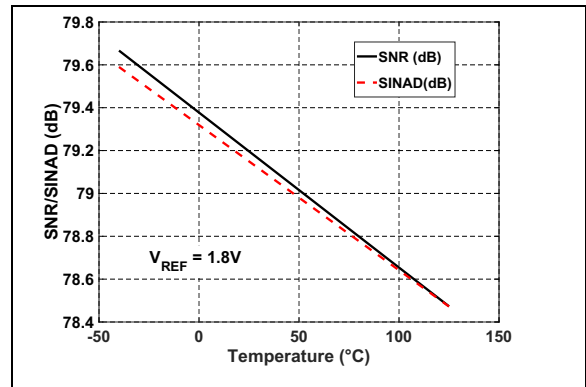

FIGURE 2-17: SNR/SINAD vs. Temperature: $V_{REF} = 1.8\text{V}$.

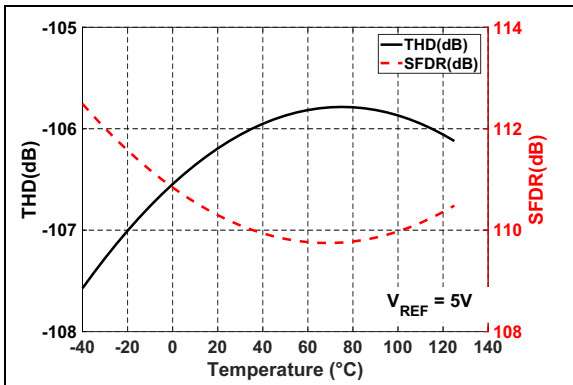

FIGURE 2-15: THD/SFDR vs. Temperature: $V_{REF} = 5\text{V}$.

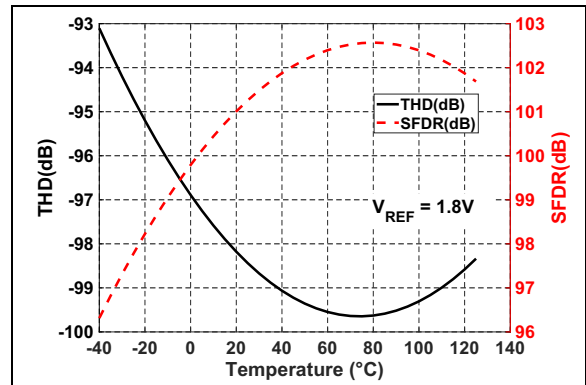

FIGURE 2-18: THD/SFDR vs. Temperature: $V_{REF} = 1.8\text{V}$.

MCP33151D/41D-XX

Note: Unless otherwise specified, all parameters apply for $T_A = +25^\circ\text{C}$, $AV_{DD} = 1.8\text{V}$, $DV_{IO} = 3.3\text{V}$, $V_{REF} = 5\text{V}$, $GND = 0\text{V}$, Differential Analog Input (V_{IN}) = -1 dBFS, $f_{IN} = 10\text{ kHz}$, $C_{LOAD_SDO} = 20\text{ pF}$.
MCP33151D-10: Sample Rate (f_S) = 1 Msp/s, SPI Clock Input = 60 MHz.
MCP33151D-05: Sample Rate (f_S) = 500 kSPS, SPI Clock Input = 30 MHz.

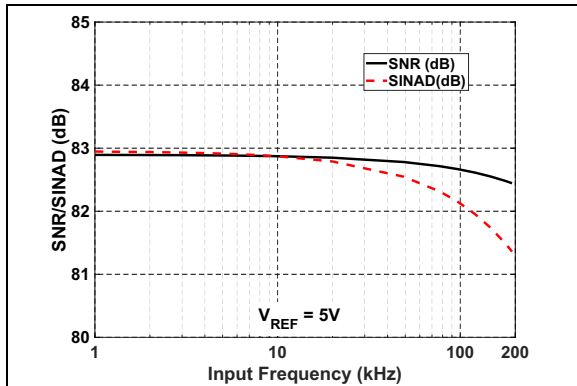

FIGURE 2-19: SNR/SINAD vs. Input Frequency: $V_{REF} = 5\text{V}$.

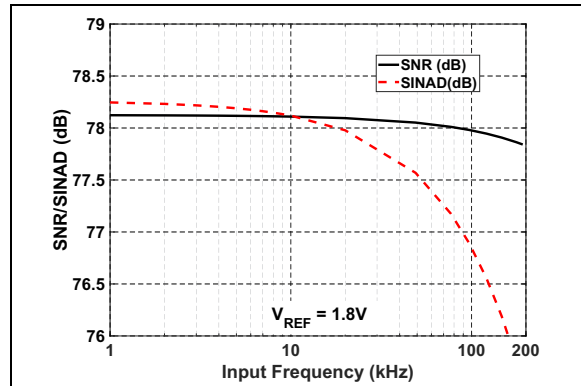

FIGURE 2-22: SNR/SINAD vs. Input Frequency: $V_{REF} = 1.8\text{V}$.

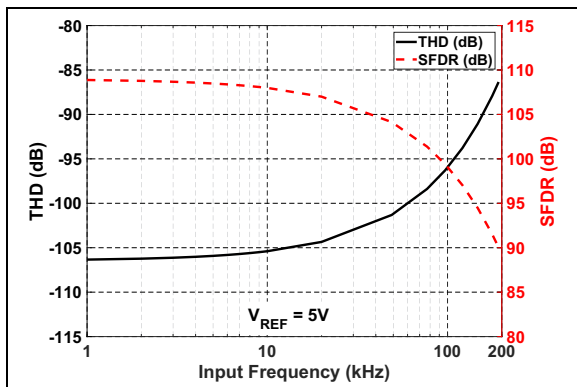

FIGURE 2-20: THD/SFDR vs. Input Frequency: $V_{REF} = 5\text{V}$.

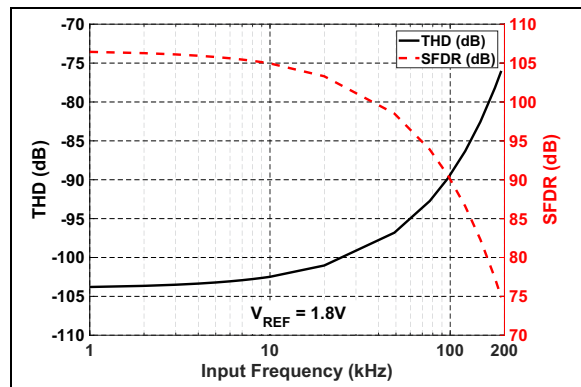

FIGURE 2-23: THD/SFDR vs. Input Frequency: $V_{REF} = 1.8\text{V}$.

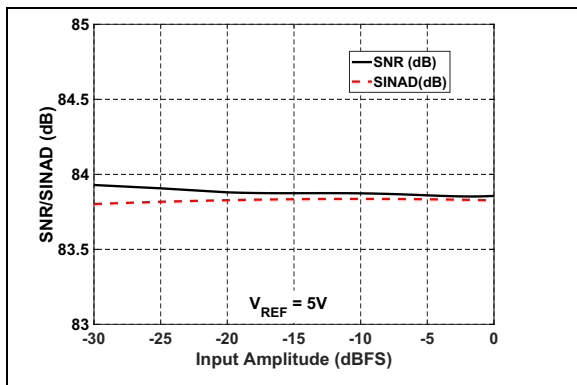

FIGURE 2-21: SNR/SINAD vs. Input Amplitude: $V_{REF} = 5\text{V}$.

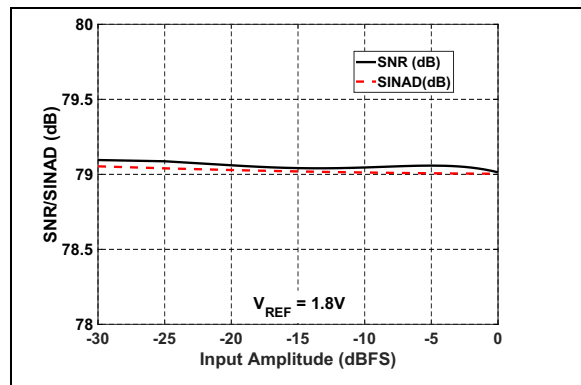

FIGURE 2-24: SNR/SINAD vs. Input Amplitude: $V_{REF} = 1.8\text{V}$.

MCP33151D/41D-XX

Note: Unless otherwise specified, all parameters apply for $T_A = +25^\circ\text{C}$, $AV_{DD} = 1.8\text{V}$, $DV_{IO} = 3.3\text{V}$, $V_{REF} = 5\text{V}$, $GND = 0\text{V}$, Differential Analog Input (V_{IN}) = -1 dBFS, $f_{IN} = 10\text{ kHz}$, $C_{LOAD_SDO} = 20\text{ pF}$.
MCP33151D-10: Sample Rate (f_S) = 1 Msps, SPI Clock Input = 60 MHz.
MCP33151D-05: Sample Rate (f_S) = 500 kSPS, SPI Clock Input = 30 MHz.

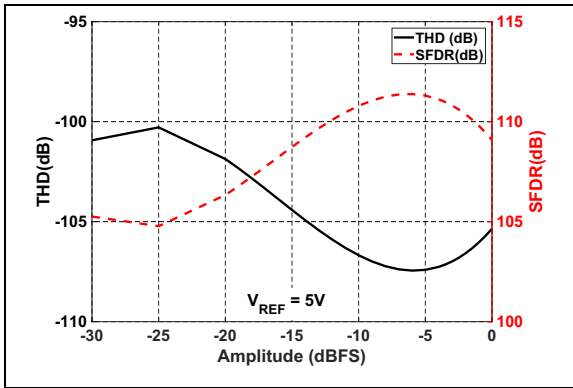

FIGURE 2-25: THD/SFDR vs. Input Amplitude: $V_{REF} = 5\text{V}$.

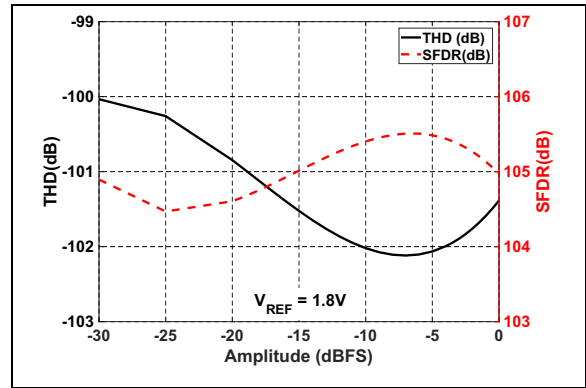

FIGURE 2-28: THD/SFDR vs. Input Amplitude: $V_{REF} = 1.8\text{V}$.

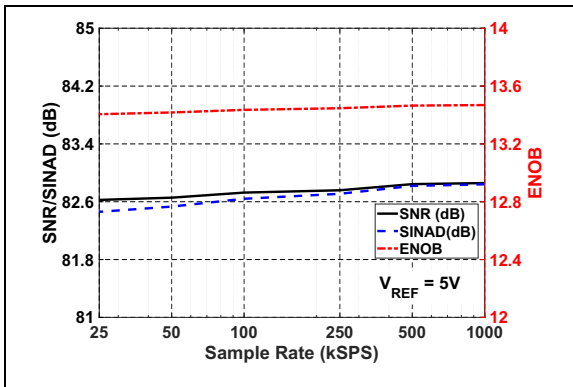

FIGURE 2-26: SNR/SINAD/ENOB vs. Sample Rate: $V_{REF} = 5\text{V}$.

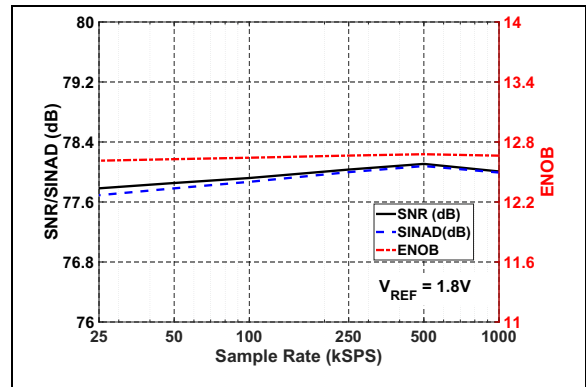

FIGURE 2-29: SNR/SINAD/ENOB vs. Sample Rate: $V_{REF} = 1.8\text{V}$.

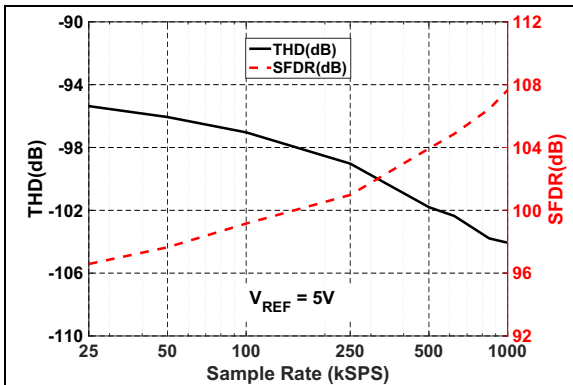

FIGURE 2-27: THD/SFDR vs Sample Rate: $V_{REF} = 5\text{V}$.

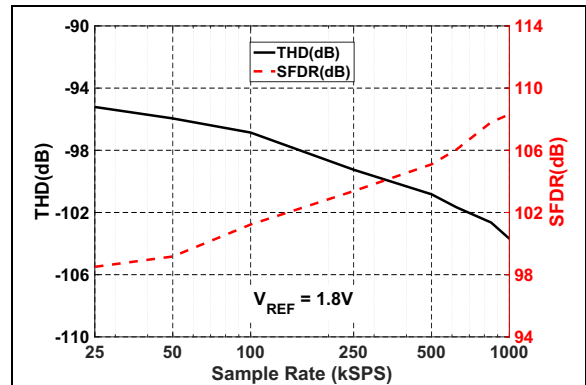

FIGURE 2-30: THD/SFDR vs Sample Rate: $V_{REF} = 1.8\text{V}$.

MCP33151D/41D-XX

Note: Unless otherwise specified, all parameters apply for $T_A = +25^\circ\text{C}$, $AV_{DD} = 1.8\text{V}$, $DV_{IO} = 3.3\text{V}$, $V_{REF} = 5\text{V}$, $GND = 0\text{V}$, Differential Analog Input (V_{IN}) = -1 dBFS, $f_{IN} = 10\text{ kHz}$, $C_{LOAD_SDO} = 20\text{ pF}$.
MCP33151D-10: Sample Rate (f_S) = 1 Msp/s, SPI Clock Input = 60 MHz.
MCP33151D-05: Sample Rate (f_S) = 500 kSPS, SPI Clock Input = 30 MHz.

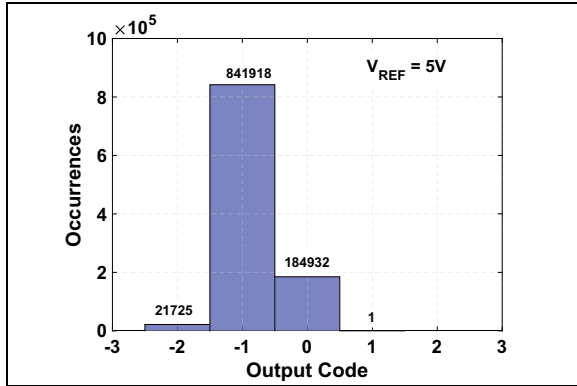

FIGURE 2-31: Shorted Input Histogram: $V_{REF} = 5\text{V}$.

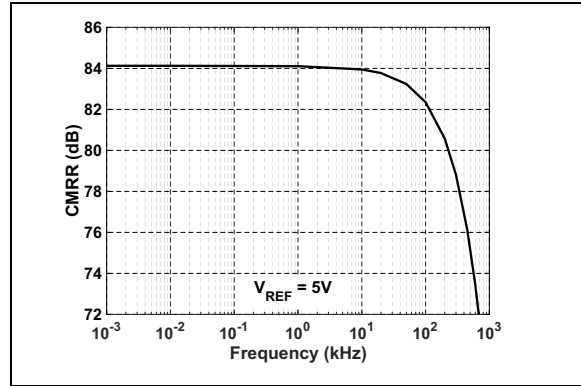

FIGURE 2-34: CMRR vs. Input Frequency: $V_{REF} = 5\text{V}$.

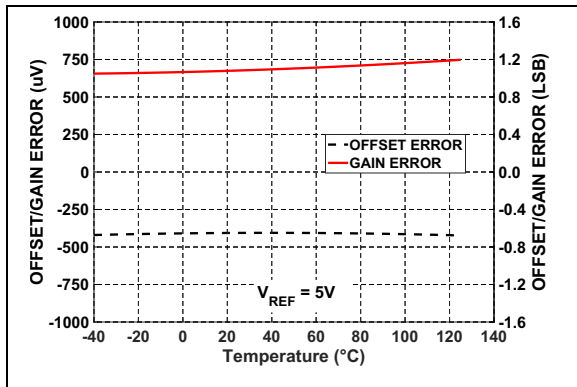

FIGURE 2-32: Offset and Gain Error vs. Temperature: $V_{REF} = 5\text{V}$.

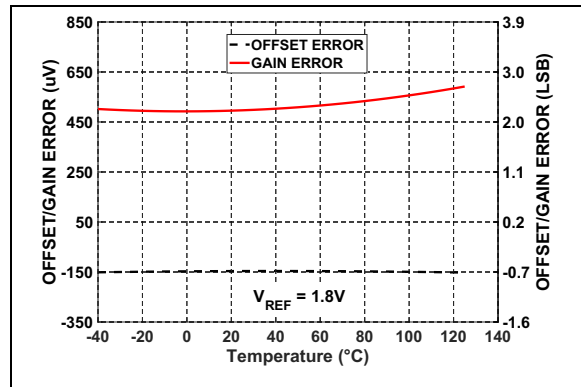

FIGURE 2-35: Offset and Gain Error vs. Temperature: $V_{REF} = 1.8\text{V}$.

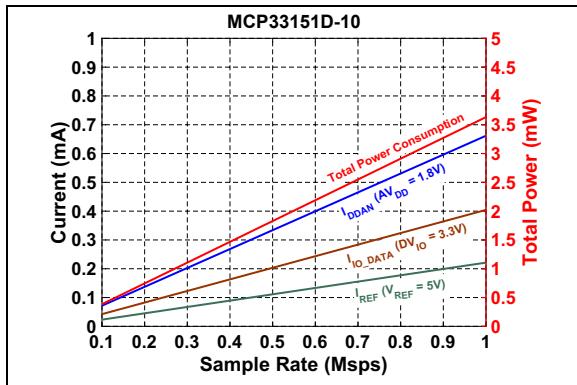

FIGURE 2-33: Power Consumption vs. Sample Rate, MCP33151D-10: $C_{LOAD_SDO} = 20\text{ pF}$.

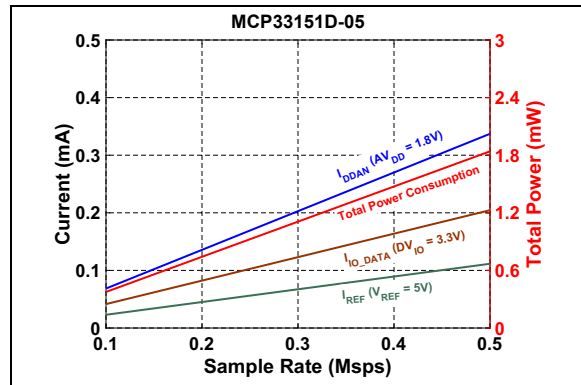

FIGURE 2-36: Power Consumption vs. Sample Rate, MCP33151D-05: $C_{LOAD_SDO} = 20\text{ pF}$.

MCP33151D/41D-XX

Note: Unless otherwise specified, all parameters apply for $T_A = +25^\circ\text{C}$, $AV_{DD} = 1.8\text{V}$, $DV_{IO} = 3.3\text{V}$, $V_{REF} = 5\text{V}$, $GND = 0\text{V}$, Differential Analog Input (V_{IN}) = -1 dBFS, $f_{IN} = 10\text{ kHz}$, $C_{LOAD_SDO} = 20\text{ pF}$.
MCP33151D-10: Sample Rate (f_S) = 1 Msps, SPI Clock Input = 60 MHz.
MCP33151D-05: Sample Rate (f_S) = 500 kSPS, SPI Clock Input = 30 MHz.

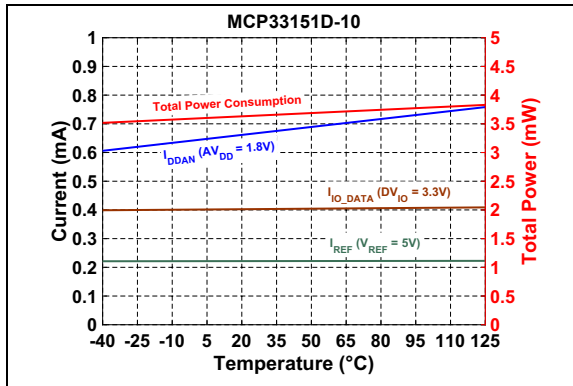

FIGURE 2-37: Power Consumption vs. Temperature, MCP33151D-10:
 $C_{LOAD_SDO} = 20\text{ pF}$.

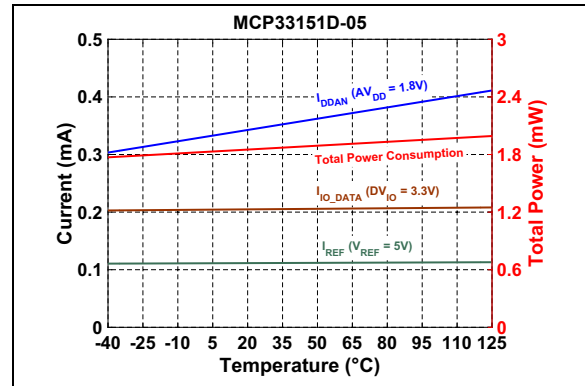

FIGURE 2-39: Power Consumption vs. Temperature, MCP33151D-05:
 $C_{LOAD_SDO} = 20\text{ pF}$.

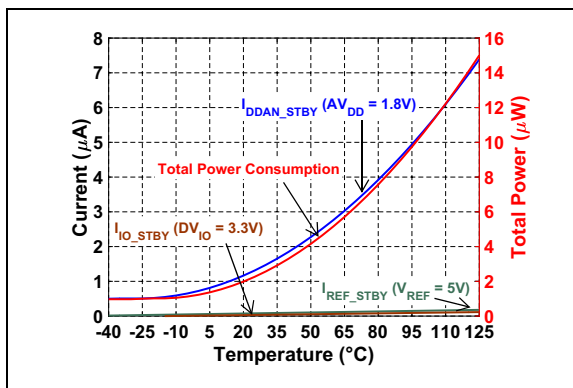

FIGURE 2-38: Power Consumption vs. Temperature during Shutdown (Standby).

MCP33151D/41D-XX

NOTES:

3.0 TYPICAL PERFORMANCE CURVES FOR 12-BIT DEVICES (MCP33141D-XX)

Note: The graphs and tables provided following this note are a statistical summary based on a limited number of samples and are provided for informational purposes only. The performance characteristics listed herein are not tested or guaranteed. In some graphs or tables, the data presented may be outside the specified operating range (e.g., outside specified power supply range) and therefore outside the warranted range.

Note: Unless otherwise specified, all parameters apply for $T_A = +25^\circ\text{C}$, $AV_{DD} = 1.8\text{V}$, $DV_{IO} = 3.3\text{V}$, $V_{REF} = 5\text{V}$, $\text{GND} = 0\text{V}$, Differential Analog Input (V_{IN}) = -1 dBFS, $f_{IN} = 10\text{ kHz}$, $C_{LOAD_SDO} = 20\text{ pF}$.
MCP33141D-10: Sample Rate (f_S) = 1 Msps, SPI Clock Input = 60 MHz.
MCP33141D-05: Sample Rate (f_S) = 500 kSPS, SPI Clock Input = 30 MHz.

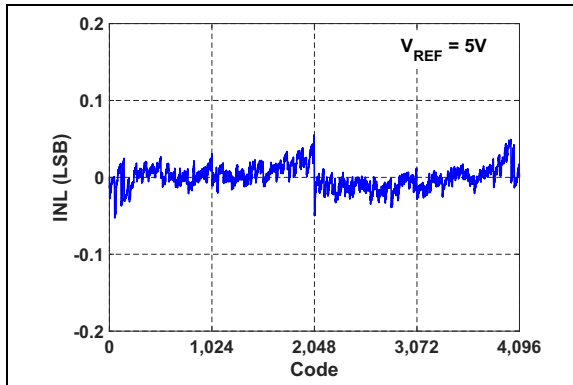

FIGURE 3-1: INL vs. Output Code:
 $V_{REF} = 5\text{V}$.

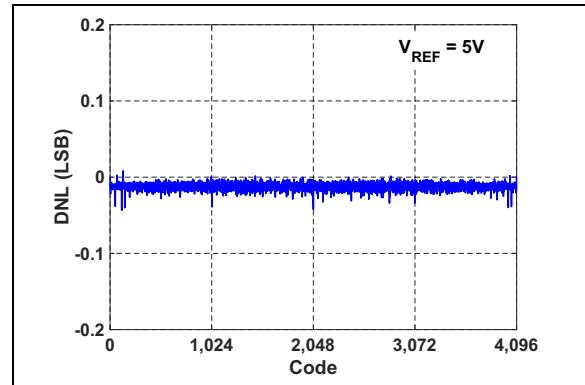

FIGURE 3-4: DNL vs. Output Code:
 $V_{REF} = 5\text{V}$.

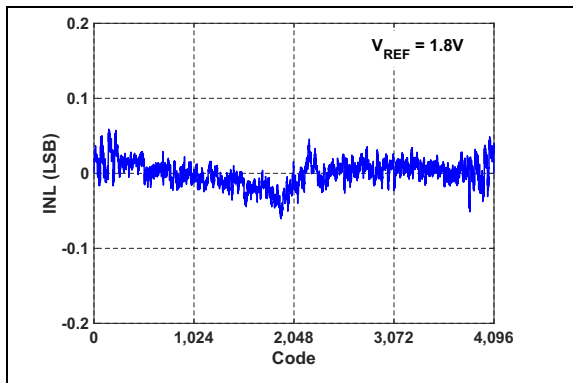

FIGURE 3-2: INL vs. Output Code:
 $V_{REF} = 1.8\text{V}$.

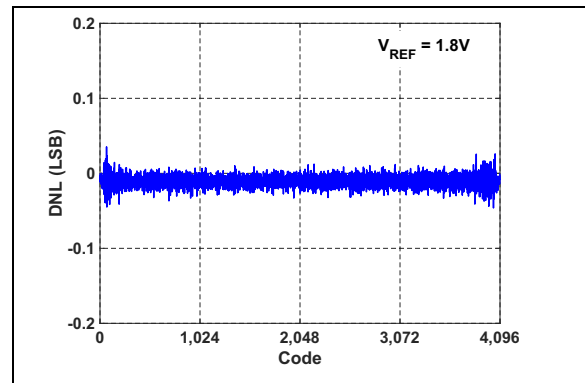

FIGURE 3-5: DNL vs. Output Code:
 $V_{REF} = 1.8\text{V}$.

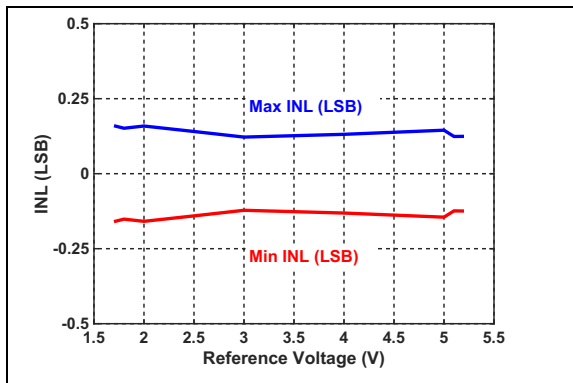

FIGURE 3-3: INL vs. Reference Voltage.

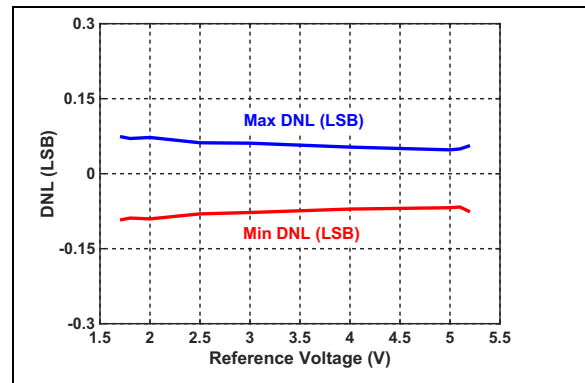

FIGURE 3-6: DNL vs. Reference Voltage.

MCP33151D/41D-XX

Note: Unless otherwise specified, all parameters apply for $T_A = +25^\circ\text{C}$, $V_{DD} = 1.8\text{V}$, $DV_{IO} = 3.3\text{V}$, $V_{REF} = 5\text{V}$, $\text{GND} = 0\text{V}$, Differential Analog Input (V_{IN}) = -1 dBFS, $f_{IN} = 10\text{ kHz}$, $C_{LOAD_SDO} = 20\text{ pF}$.
MCP33141D-10: Sample Rate (f_S) = 1 MspS, SPI Clock Input = 60 MHz.
MCP33141D-05: Sample Rate (f_S) = 500 kSPS, SPI Clock Input = 30 MHz.

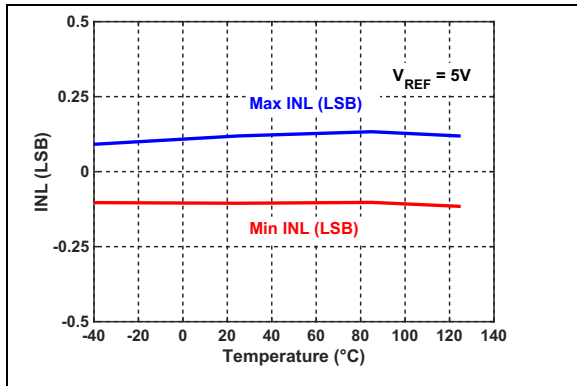

FIGURE 3-7: INL vs. Temperature.

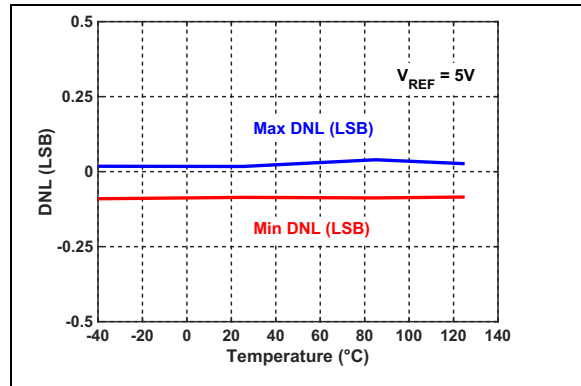

FIGURE 3-10: DNL vs. Temperature.

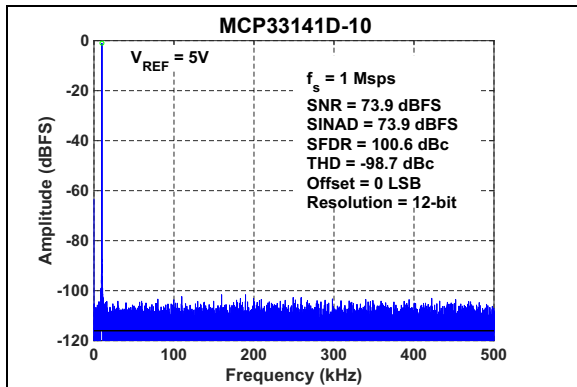

FIGURE 3-8: FFT for 10 kHz Input Signal: $f_S = 1\text{ MspS}$, $V_{IN} = -1\text{ dBFS}$, $V_{REF} = 5\text{V}$.

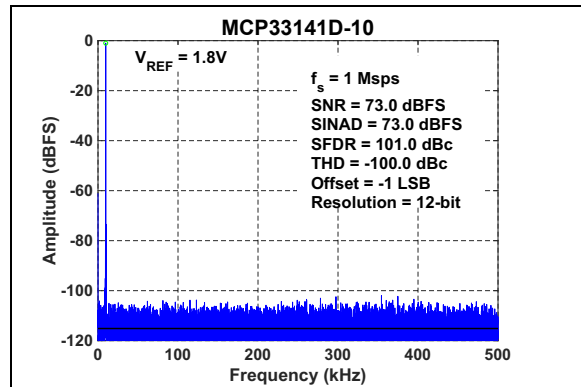

FIGURE 3-11: FFT for 10 kHz Input Signal: $f_S = 1\text{ MspS}$, $V_{IN} = -1\text{ dBFS}$, $V_{REF} = 1.8\text{V}$.

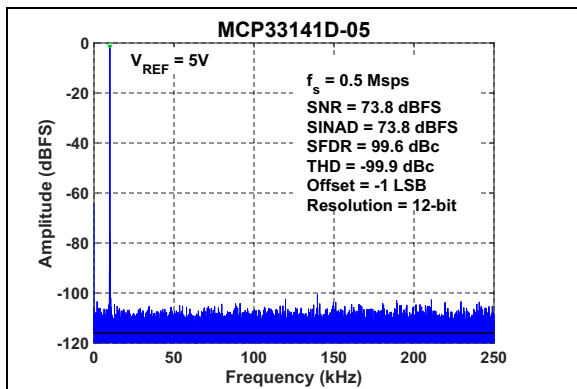

FIGURE 3-9: FFT for 10 kHz Input Signal: $f_S = 500\text{ kSPS}$, $V_{IN} = -1\text{ dBFS}$, $V_{REF} = 5\text{V}$.

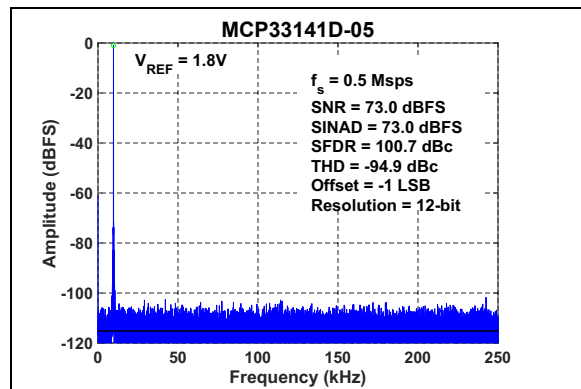

FIGURE 3-12: FFT for 10 kHz Input Signal: $f_S = 500\text{ kSPS}$, $V_{IN} = -1\text{ dBFS}$, $V_{REF} = 1.8\text{V}$.

MCP33151D/41D-XX

Note: Unless otherwise specified, all parameters apply for $T_A = +25^\circ\text{C}$, $AV_{DD} = 1.8\text{V}$, $DV_{IO} = 3.3\text{V}$, $V_{REF} = 5\text{V}$, $\text{GND} = 0\text{V}$, Differential Analog Input (V_{IN}) = -1 dBFS, $f_{IN} = 10\text{ kHz}$, $C_{LOAD_SDO} = 20\text{ pF}$.
MCP33141D-10: Sample Rate (f_S) = 1 Msps, SPI Clock Input = 60 MHz.
MCP33141D-05: Sample Rate (f_S) = 500 kSPS, SPI Clock Input = 30 MHz.

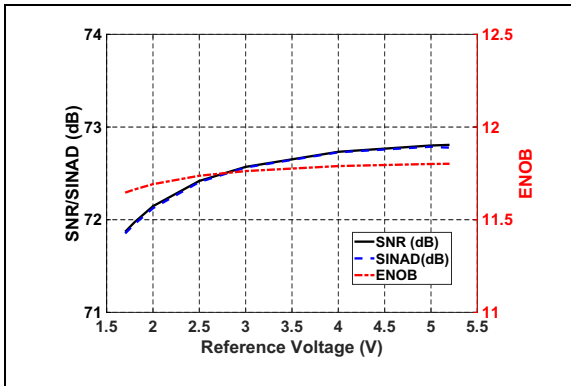

FIGURE 3-13: SNR/SINAD/ENOB vs. Reference Voltage.

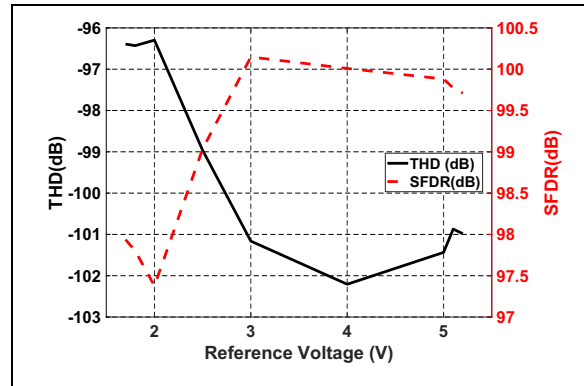

FIGURE 3-16: THD/SFDR vs. Reference Voltage.

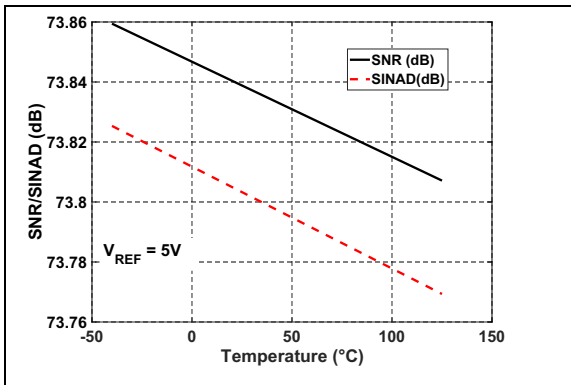

FIGURE 3-14: SNR/SINAD vs. Temperature: $V_{REF} = 5\text{V}$.

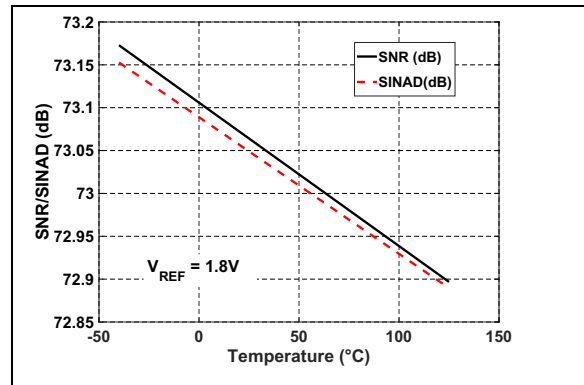

FIGURE 3-17: SNR/SINAD vs. Temperature: $V_{REF} = 1.8\text{V}$.

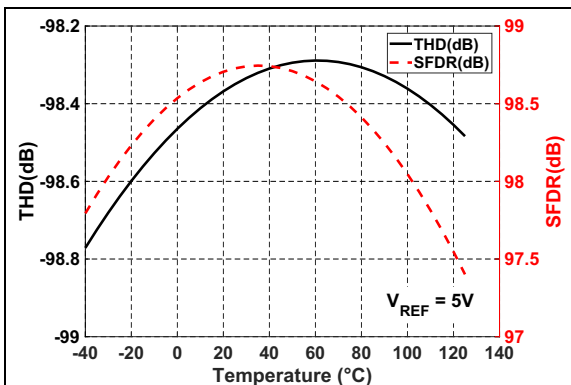

FIGURE 3-15: THD/SFDR vs. Temperature: $V_{REF} = 5\text{V}$.

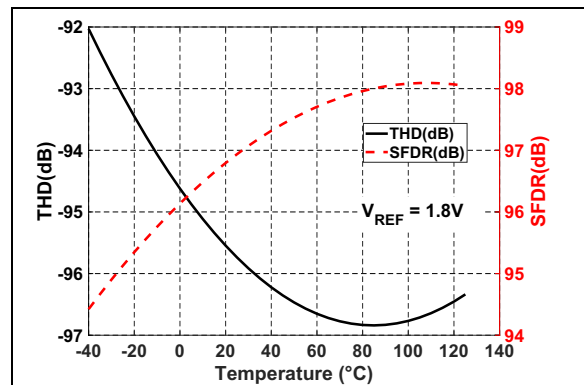

FIGURE 3-18: THD/SFDR vs. Temperature: $V_{REF} = 5\text{V}$.

MCP33151D/41D-XX

Note: Unless otherwise specified, all parameters apply for $T_A = +25^\circ\text{C}$, $V_{DD} = 1.8\text{V}$, $DV_{IO} = 3.3\text{V}$, $V_{REF} = 5\text{V}$, $\text{GND} = 0\text{V}$, Differential Analog Input (V_{IN}) = -1 dBFS, $f_{IN} = 10\text{ kHz}$, $C_{LOAD_SDO} = 20\text{ pF}$.
MCP33141D-10: Sample Rate (f_S) = 1 Msp/s, SPI Clock Input = 60 MHz.
MCP33141D-05: Sample Rate (f_S) = 500 kSPS, SPI Clock Input = 30 MHz.

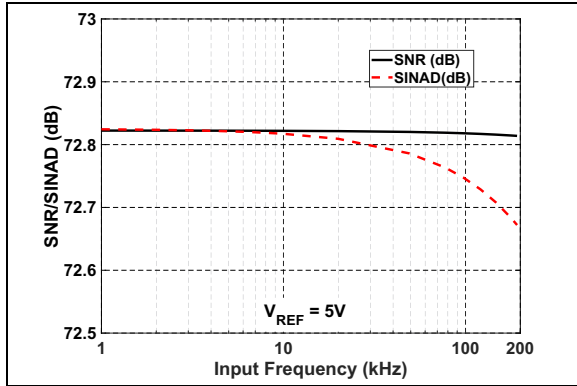

FIGURE 3-19: SNR/SINAD vs. Input Frequency: $V_{REF} = 5\text{V}$.

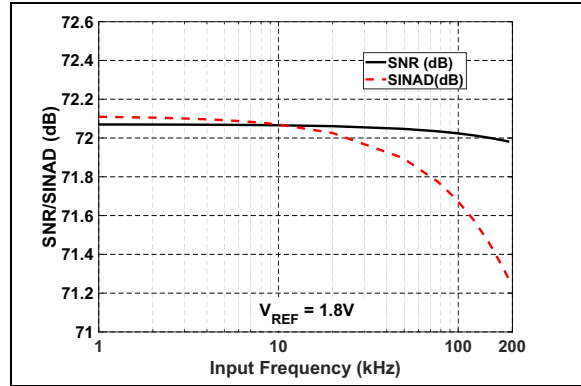

FIGURE 3-22: SNR/SINAD vs. Input Frequency: $V_{REF} = 1.8\text{V}$.

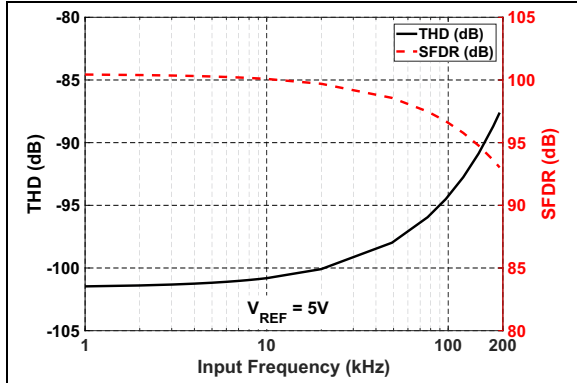

FIGURE 3-20: THD/SFDR vs. Input Frequency: $V_{REF} = 5\text{V}$.

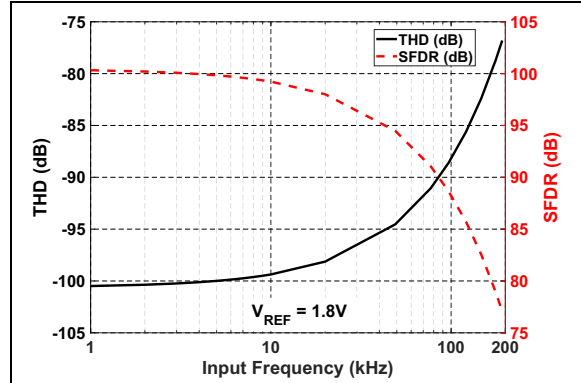

FIGURE 3-23: THD/SFDR vs. Input Frequency: $V_{REF} = 1.8\text{V}$.

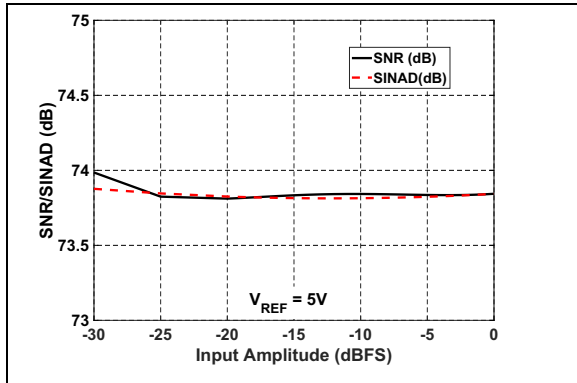

FIGURE 3-21: SNR/SINAD vs. Input Amplitude: $V_{REF} = 5\text{V}$.

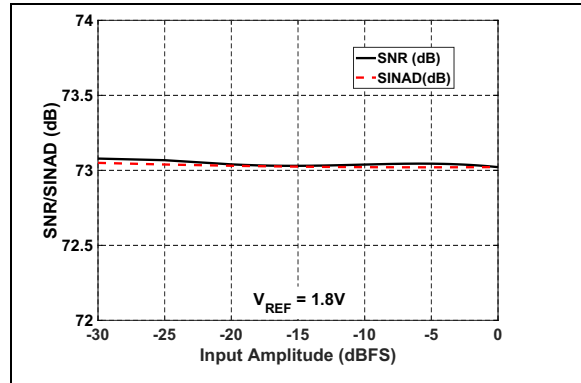

FIGURE 3-24: SNR/SINAD vs. Input Amplitude: $V_{REF} = 1.8\text{V}$.

MCP33151D/41D-XX

Note: Unless otherwise specified, all parameters apply for $T_A = +25^\circ\text{C}$, $AV_{DD} = 1.8\text{V}$, $DV_{IO} = 3.3\text{V}$, $V_{REF} = 5\text{V}$, $\text{GND} = 0\text{V}$, Differential Analog Input (V_{IN}) = -1 dBFS, $f_{IN} = 10\text{ kHz}$, $C_{LOAD_SDO} = 20\text{ pF}$.
MCP33141D-10: Sample Rate (f_s) = 1 MspS, SPI Clock Input = 60 MHz.
MCP33141D-05: Sample Rate (f_s) = 500 kSPS, SPI Clock Input = 30 MHz.

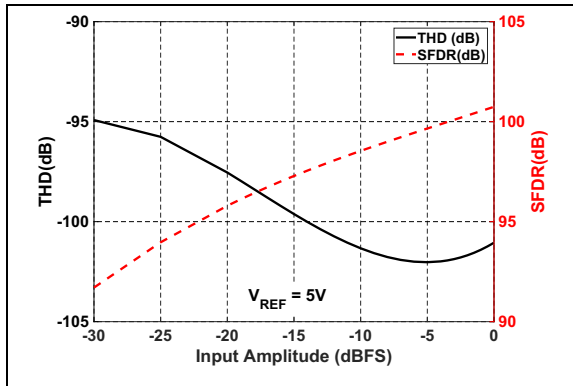

FIGURE 3-25: THD/SFDR vs. Input Amplitude: $V_{REF} = 5\text{V}$.

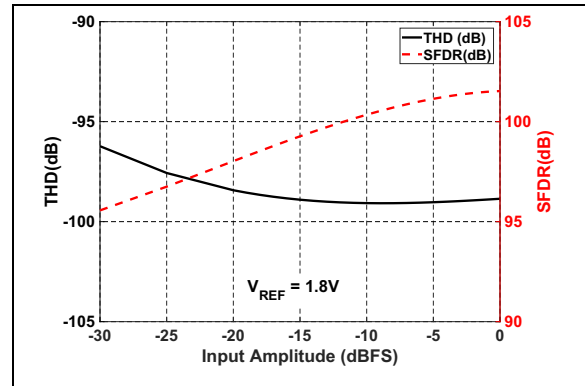

FIGURE 3-28: THD/SFDR vs. Input Amplitude: $V_{REF} = 1.8\text{V}$.

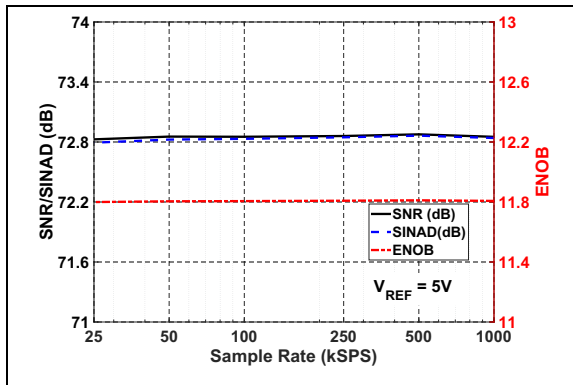

FIGURE 3-26: SNR/SINAD/ENOB vs. Sample Rate: $V_{REF} = 5\text{V}$.

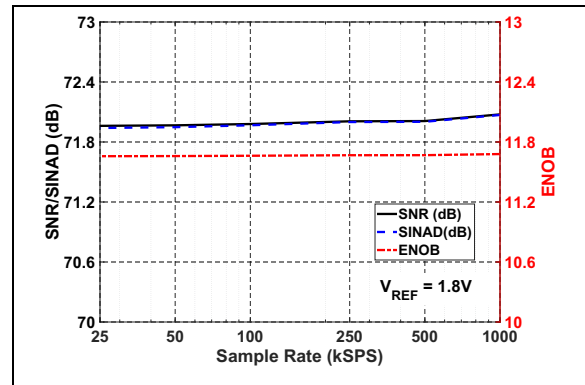

FIGURE 3-29: SNR/SINAD/ENOB vs. Sample Rate: $V_{REF} = 1.8\text{V}$.

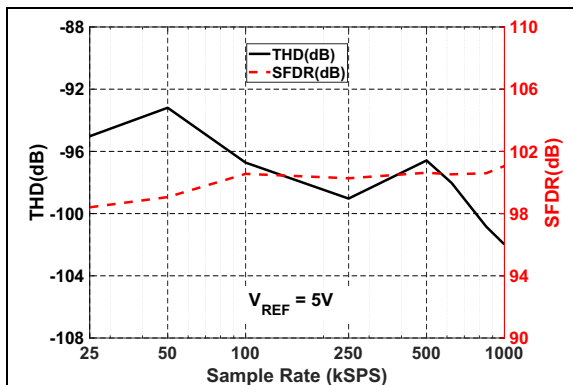

FIGURE 3-27: THD/SFDR vs. Sample Rate: $V_{REF} = 5\text{V}$.

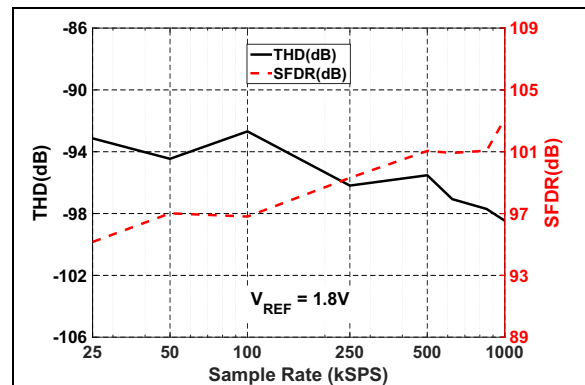

FIGURE 3-30: THD/SFDR vs. Sample Rate: $V_{REF} = 1.8\text{V}$.

MCP33151D/41D-XX

Note: Unless otherwise specified, all parameters apply for $T_A = +25^\circ\text{C}$, $V_{DD} = 1.8\text{V}$, $DV_{IO} = 3.3\text{V}$, $V_{REF} = 5\text{V}$, $\text{GND} = 0\text{V}$, Differential Analog Input (V_{IN}) = -1 dBFS, $f_{IN} = 10\text{ kHz}$, $C_{LOAD_SDO} = 20\text{ pF}$.
MCP33141D-10: Sample Rate (f_S) = 1 Msp/s, SPI Clock Input = 60 MHz.
MCP33141D-05: Sample Rate (f_S) = 500 kSPS, SPI Clock Input = 30 MHz.

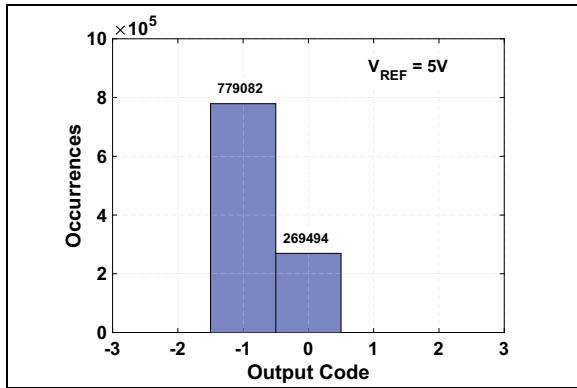

FIGURE 3-31: Shorted Input Histogram: $V_{REF} = 5\text{V}$.

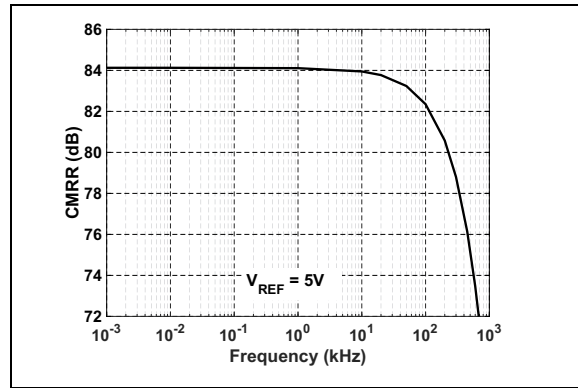

FIGURE 3-34: CMRR vs. Input Frequency: $V_{REF} = 5\text{V}$.

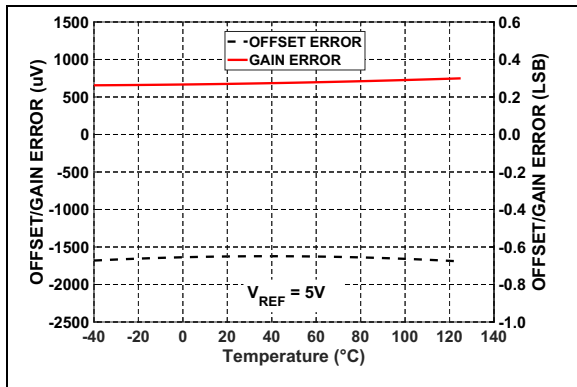

FIGURE 3-32: Offset and Gain Error vs. Temperature: $V_{REF} = 5\text{V}$.

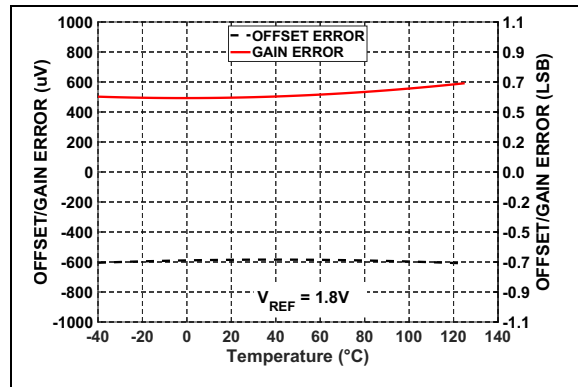

FIGURE 3-35: Offset and Gain Error vs. Temperature: $V_{REF} = 1.8\text{V}$.

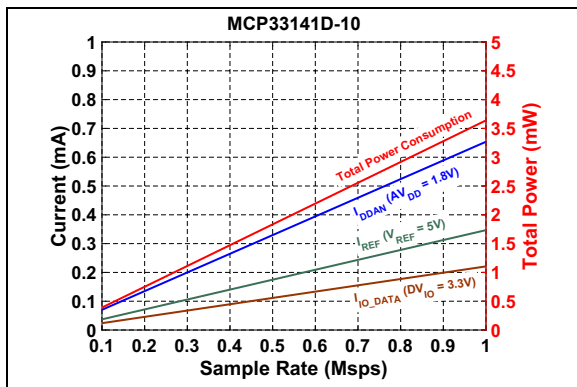

FIGURE 3-33: Power Consumption vs. Sample Rate, MCP33141D-10: $C_{LOAD_SDO} = 20\text{ pF}$.

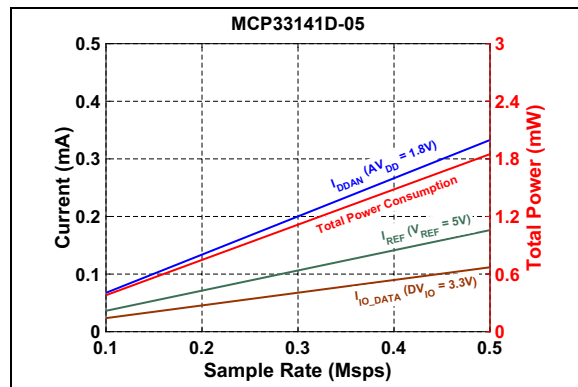

FIGURE 3-36: Power Consumption vs. Sample Rate, MCP33141D-05: $C_{LOAD_SDO} = 20\text{ pF}$.

MCP33151D/41D-XX

Note: Unless otherwise specified, all parameters apply for $T_A = +25^\circ\text{C}$, $AV_{DD} = 1.8\text{V}$, $DV_{IO} = 3.3\text{V}$, $V_{REF} = 5\text{V}$, $\text{GND} = 0\text{V}$, Differential Analog Input (V_{IN}) = -1 dBFS, $f_{IN} = 10\text{ kHz}$, $C_{LOAD_SDO} = 20\text{ pF}$.
MCP33141D-10: Sample Rate (f_S) = 1 Msp/s, SPI Clock Input = 60 MHz.
MCP33141D-05: Sample Rate (f_S) = 500 kSPS, SPI Clock Input = 30 MHz.

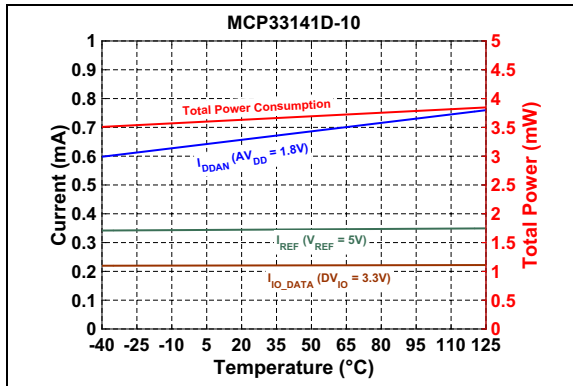

FIGURE 3-37: Power Consumption vs. Temperature, MCP33141D-10:
 $C_{LOAD_SDO} = 20\text{ pF}$.

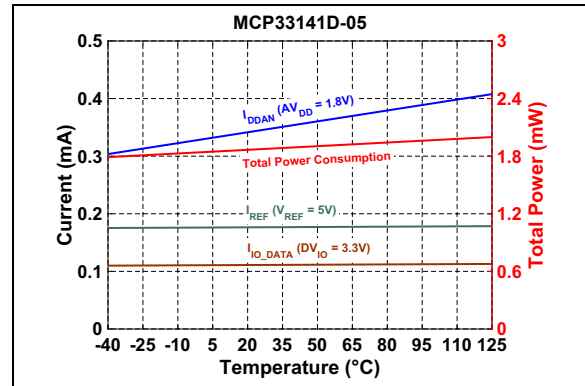

FIGURE 3-39: Power Consumption vs. Temperature, MCP33141D-05:
 $C_{LOAD_SDO} = 20\text{ pF}$.

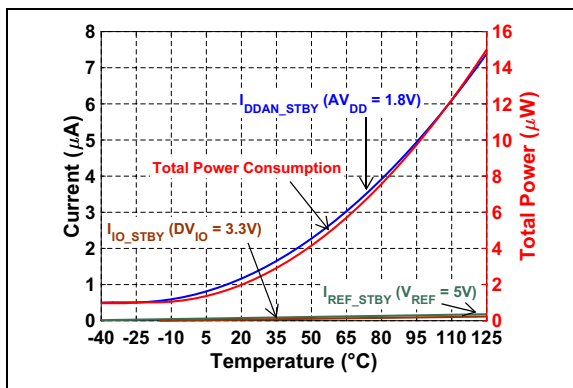

FIGURE 3-38: Power Consumption vs. Temperature during Shutdown (Standby).

MCP33151D/41D-XX

NOTES:

4.0 PIN DESCRIPTIONS

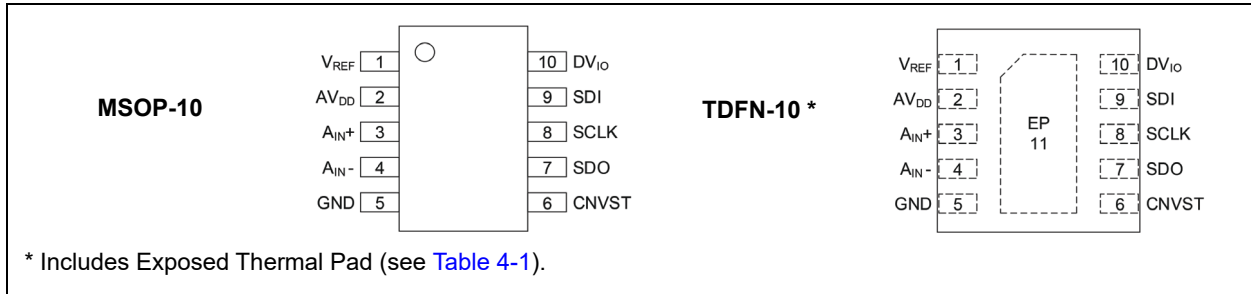

FIGURE 4-1: Pin Configurations.

TABLE 4-1: PIN FUNCTION TABLE

Pin Number		Pin Name	Description
MSOP-10	TDFN-10		
1	1	V_{REF}	Reference voltage input ($AV_{DD} - 5.1V$). This pin should be decoupled with a 10 μF tantalum capacitor.
2	2	AV_{DD}	DC supply voltage input for analog section (1.8V). This pin should be decoupled with a 1 μF ceramic capacitor.
3	3	A_{IN+}	Differential positive analog input.
4	4	A_{IN-}	Differential negative analog input.
5	5	GND	Power supply ground reference. This pin is a common ground for both the analog power supply (AV_{DD}) and digital I/O supply (DV_{IO}).
6	6	CNVST	Conversion-start control and active-low SPI chip-select digital input. A new conversion is started on the rising edge of CNVST. When the conversion is complete, output data is available at SDO by lowering CNVST.
7	7	SDO	SPI-compatible serial digital data output: ADC conversion data is shifted out by SCLK clock, with MSB first.
8	8	SCLK	SPI-compatible serial data clock digital input. The ADC output is synchronously shifted out by this clock.
9	9	SDI	SPI-compatible serial data digital input. Tie to DV_{IO} for normal operation.
10	10	DV_{IO}	DC supply voltage for digital input/output interface (1.7V - 5.5V). This pin should be decoupled with a 0.1 μF ceramic capacitor.
—	11	EP	Exposed Thermal Pad. Not internally bonded (NC).

MCP33151D/41D-XX

4.1 Supply Voltages (AV_{DD} , DV_{IO})

The device has two power supply pins: (a) 1.8V analog power supply (AV_{DD}), and (b) 1.7V to 5.5V digital input/output interface power supply (DV_{IO}). Since DV_{IO} has a very wide voltage range, some I/O interface signal parameters have slightly different timing specifications depending on the DV_{IO} value. See [Serial Interface Timing Specifications](#) for details.

Note: Proper decoupling capacitors (1 μ F to AV_{DD} , 0.1 μ F to DV_{IO}) should be mounted as close as possible to the respective pins.

4.2 Reference Voltage (V_{REF})

The device requires a single-ended external reference voltage (V_{REF}). The external input reference range is from AV_{DD} to 5.1V. This reference voltage sets the differential input full-scale range from $-V_{REF}$ to $+V_{REF}$.

The reference pin needs a tantalum decoupling capacitor (10 μ F, 10V rating). Additional multiple ceramic capacitors can be added in parallel to decouple high-frequency noise.

4.2.1 VOLTAGE REFERENCE SELECTION

The performance of the voltage reference has a large impact on the accuracy of high-precision data acquisition systems. The voltage reference should have high accuracy, low-noise, and low-temperature drift. A $\pm 0.1\%$ output accuracy of the reference directly corresponds to $\pm 0.1\%$ absolute accuracy of the ADC output. The RMS output noise voltage of the reference must be less than 1/2 LSB of the ADC.

4.3 Power-Up Sequence and Auto-Calibration

The device will perform an automatic calibration on power-up approximately 40 ms after all three power rails (AV_{DD} , DV_{IO} , and V_{REF}) are powered by their respective voltage supplies. The calibration process will take approximately 400 ms to complete before the device will be ready for acquisition. To avoid potential auto-calibration issues, all supplies must be fully stabilized < 40 ms from the moment power is initially supplied. All digital activity must be avoided prior to and during device calibration. At higher operating temperatures ($>85^{\circ}\text{C}$) it may be necessary to provide additional time for the device to complete calibration (up to 550ms at 125°C). Therefore it is advisable to wait at least 450-500 ms following power-on before initiating any other activity. Otherwise, it may be necessary to send a manual recalibration command to ensure proper operation. See [Figure 4-2](#) for example power-on operation timing, and refer to [Section 6.2 "Recalibrate Command"](#) for more details regarding initiating manual recalibration. Once the device finishes calibration it will automatically enter Acquisition (ACQ) mode.

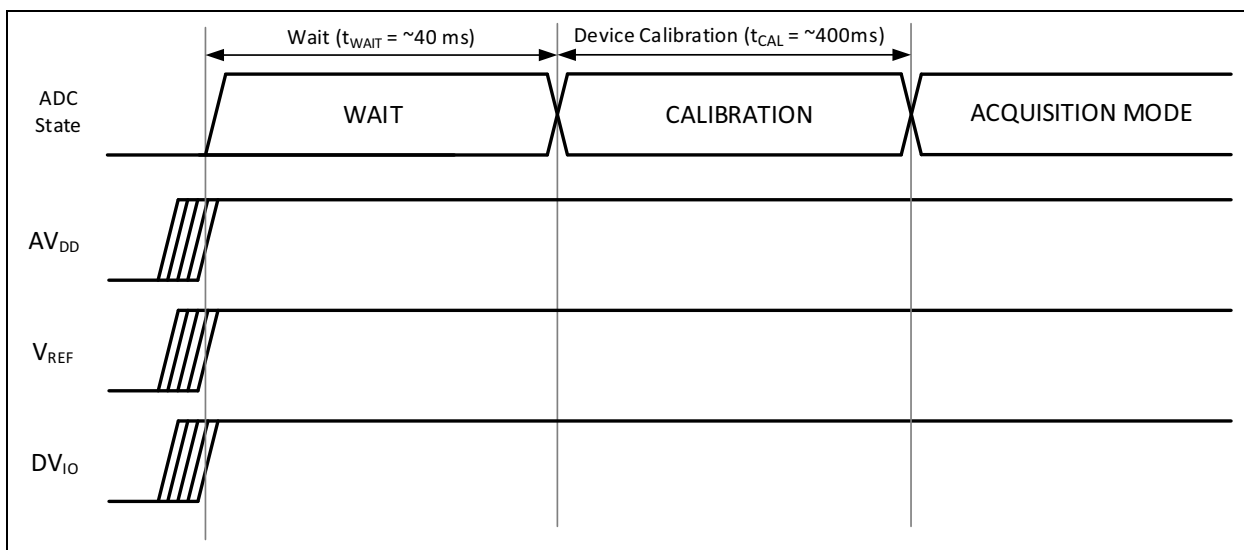

FIGURE 4-2: Power-Up Sequence and Auto-Calibration Timing Diagram.

Note: Unlike manual recalibration, there will be no activity on SDO to indicate completion of auto-calibration. Refer to [Section 6.2 "Recalibrate Command"](#) for more details.

5.0 DEVICE OVERVIEW

When the MCP33151D/41D-XX is first powered-up, it automatically performs a self-calibration and enters a low-current input acquisition mode (Standby).

The external reference voltage (V_{REF}), ranging from A_{VDD} to 5.1V, sets the differential input full-scale range (FSR) from $-V_{REF}$ to $+V_{REF}$.

The differential input signal needs an appropriate input common-mode voltage from 0V to V_{REF} , depending on the input signal condition. $V_{REF}/2$ is typically used for a symmetric differential input.

During input acquisition (Standby), the internal input sampling capacitors are connected to the input signal, while most of the internal analog circuits are shutdown to save power. During this input acquisition time (t_{ACQ}), the device consumes a typical current of 1.5 μ A.

The user can operate the device with an easy-to-use, SPI-compatible, 3-wire interface.

The device initiates data conversion on the rising edge of the conversion-start control (CNVST). The data conversion time (t_{CNV}) is set by the internal clock. Once the conversion is complete and the host lowers CNVST, the output data is available on SDO and the device automatically starts the next input acquisition. During this input acquisition time (t_{ACQ}), the user can clock out the output data by providing the SPI-compatible serial clock (SCLK).

The device provides conversion data with no missing codes. This ADC device family has a large input full-scale range, high precision, high throughput with no output latency, and is an ideal choice for various ADC applications.

5.1 Analog Inputs

Figure 5-1 shows a simplified equivalent circuit of the differential input architecture with a switched capacitor input stage. The input sampling capacitors (C_S^+ and C_S^-) are about 10 pF each. The back-to-back diodes ($D_1 - D_2$) at each input are ESD protection diodes. Note that these ESD diodes are tied to V_{REF} , so that each input signal can swing from 0V to $+V_{REF}$ and from $-V_{REF}$ to $+V_{REF}$ differentially.

During input acquisition (Standby), the sampling switches are closed and each input sees the sampling capacitor (≈ 10 pF) in series with the on-resistance of the sampling switch, R_{SON} ($\approx 350\Omega$).

For high-precision data conversion applications, the input voltage needs to be fully settled within 1/2 LSB during the input acquisition period (t_{ACQ}). The settling time is directly related to the source impedance: A lower impedance source results in faster input settling time. Although the device can be driven directly with a low impedance source, using a low-noise input driver, such as the MCP6D11, is highly recommended.

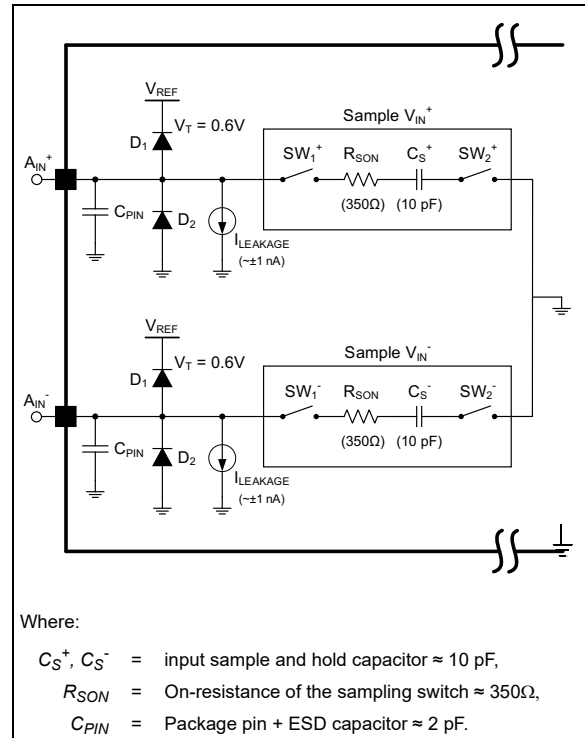

FIGURE 5-1: Simplified Equivalent Analog Input Circuit.

5.1.1 ABSOLUTE MAXIMUM INPUT VOLTAGE RANGE

The input voltage at each input pin (A_{IN+} and A_{IN-}) must meet the following absolute maximum input voltage limits:

- $(V_{IN+}, V_{IN-}) < V_{REF} + 0.1V$
- $(V_{IN+}, V_{IN-}) > GND - 0.1V$

Note: The ESD diodes at the analog input pins are biased from V_{REF} . Any input voltage outside the absolute maximum range can turn on the input ESD protection diodes and results in input leakage current which may cause conversion errors and permanent damage to the device. Care must be taken in setting the input voltage ranges so that the input voltage does not exceed the absolute maximum input voltage range.

MCP33151D/41D-XX

5.1.2 INPUT VOLTAGE RANGE

The differential input (V_{IN}) and common-mode voltage (V_{CM}) at the input pins are defined by [Equation 5-1](#):

EQUATION 5-1: DIFFERENTIAL INPUT

$$V_{IN} = V_{IN^+} - V_{IN^-}$$
$$V_{CM} = \frac{V_{IN^+} + V_{IN^-}}{2}$$

Where:

- V_{IN^+} = the input at the A_{IN^+} pin,
- V_{IN^-} = the input at the A_{IN^-} pin.

The input signal swings around an input common-mode voltage (V_{CM}), typically centered at $V_{REF}/2$ for the best performance.

The absolute value of the differential input (V_{IN}) needs to be less than the reference voltage. The device will output saturated output codes if the absolute value of the input (V_{IN}) is greater than the reference voltage.

Note: Saturation output codes:
011111111111111 for $V_{IN} > V_{REF}$
100000000000000 for $V_{IN} < -V_{REF}$

The differential input full-scale voltage range (FSR) is given by the external reference voltage (V_{REF}) setting (see [Equation 5-2](#)).

EQUATION 5-2: FSR AND INPUT RANGE

$$\text{Input Full-Scale Range (FSR)} = 2V_{REF}$$
$$\text{Input Range: } -V_{REF} \leq V_{IN} \leq (V_{REF} - 1 \text{ LSB})$$

5.2 Analog Input Conditioning Circuits

The MCP33151D/41D-XX supports various input types, such as: fully-differential inputs, arbitrary waveform inputs and single-ended inputs.

5.2.1 FULLY-DIFFERENTIAL INPUT SIGNALS

The MCP33151D/41D-XX provides the best linearity performance with fully-differential inputs. [Figure 5-2](#) shows an example of a fully-differential input conditioning circuit with a differential input driver followed by an RC anti-aliasing filter. [Figure 5-3](#) shows its transfer function.

The differential input (V_{IN}) between the two differential ADC analog input pins (A_{IN^+} , A_{IN^-}) swings from $-V_{REF}$ to $+V_{REF}$ centered at the input common-mode voltage (V_{OCM}).

The front-end differential driver provides a low output impedance, which provides fast settling of the analog inputs during the acquisition phase and provides isolation between the signal source and the ADC. The RC low-pass anti-aliasing filter band-limits the output noise of the input driver and attenuates the kick-back noise spikes from the ADC during conversion.

[Figure 5-2](#) is the reference circuit that is used to collect most of the linearity performance data shown in [Section 1.0 “Key Electrical Characteristics”](#).

The differential input driver shown in [Figure 5-2](#) can be replaced with a low noise dual-channel op-amp. See [Section 5.3 “ADC Input Driver Selection”](#) for the driver selection.

5.2.2 ARBITRARY WAVEFORM INPUT SIGNALS

The MCP33151D/41D-XX can convert input signals with arbitrary waveforms at the inputs A_{IN^+} and A_{IN^-} . These inputs can be symmetric, non-symmetric or independent with respect to each other.

In the arbitrary input configuration, each ADC analog input is connected to a single ended source ranging from 0V to V_{REF} . In this case, the ADC converts the voltage difference between the two input signals. [Figure 5-4](#) shows the configuration example for the arbitrary input signals.

5.2.3 SINGLE-ENDED INPUT SIGNALS

Although the MCP33151D/41D-10 is a fully-differential input device, it can also convert single-ended input signals. The most commonly recommended single-ended configurations are:

- pseudo-differential bipolar configuration, and
- pseudo-differential unipolar configuration.

5.2.3.1 Pseudo-Differential Bipolar Configuration

In the pseudo-differential bipolar configuration, one of the ADC analog inputs (typically A_{IN^-}) is driven with a fixed DC voltage (typically $V_{REF}/2$), while the other (A_{IN^+}) is connected to a single-ended signal in the range 0V to V_{REF} .

In this case, the ADC converts the voltage difference between the single-ended signal and the DC voltage. [Figure 5-5](#) shows the configuration example and [Figure 5-6](#) shows its transfer function.

5.2.3.2 Pseudo-Differential Unipolar Configuration

In the pseudo-differential unipolar input configuration, one of the ADC analog inputs (typically A_{IN-}) is connected to ground, while the other (A_{IN+}) is connected to a single ended signal in the range 0V to V_{REF} .

In this case, the ADC converts the voltage difference between the single ended signal and ground. [Figure 5-7](#) shows the configuration example and [Figure 5-8](#) shows its transfer function.

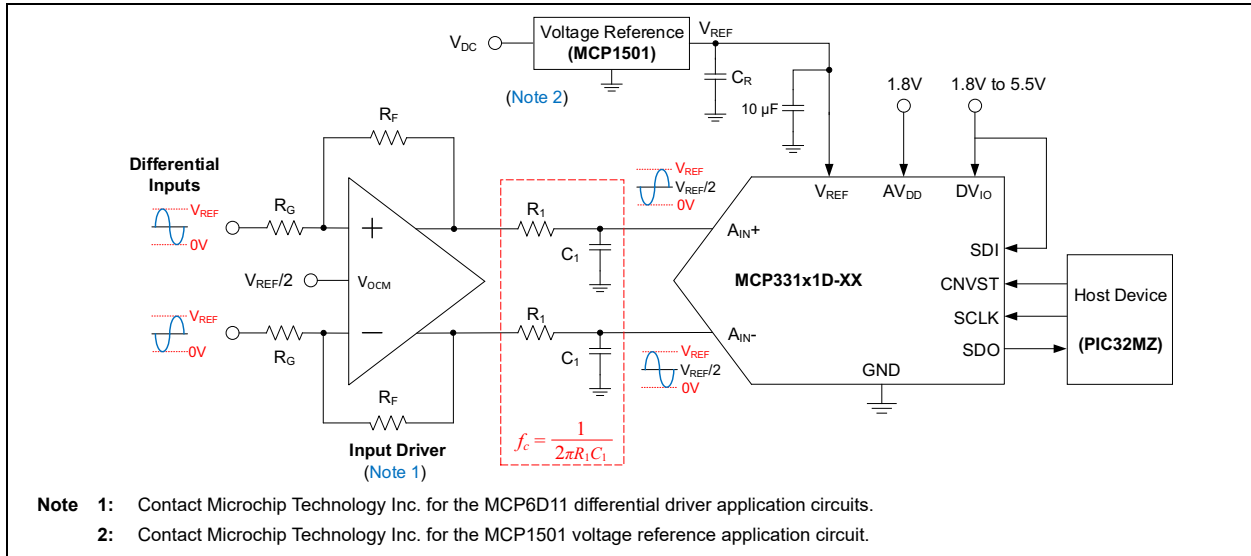
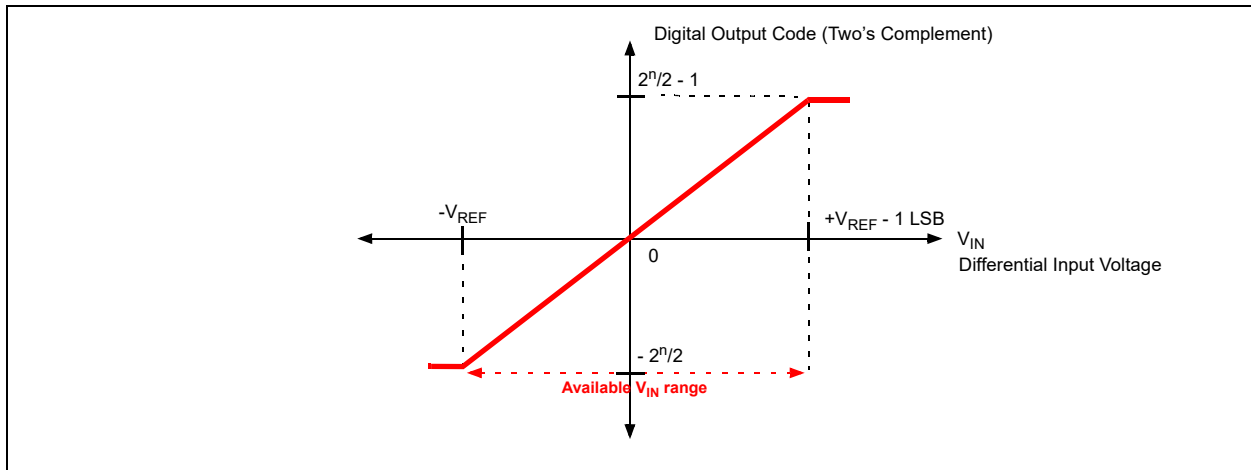

FIGURE 5-2: Input Conditional Circuit for Fully-Differential Input.



MCP33151D/41D-XX

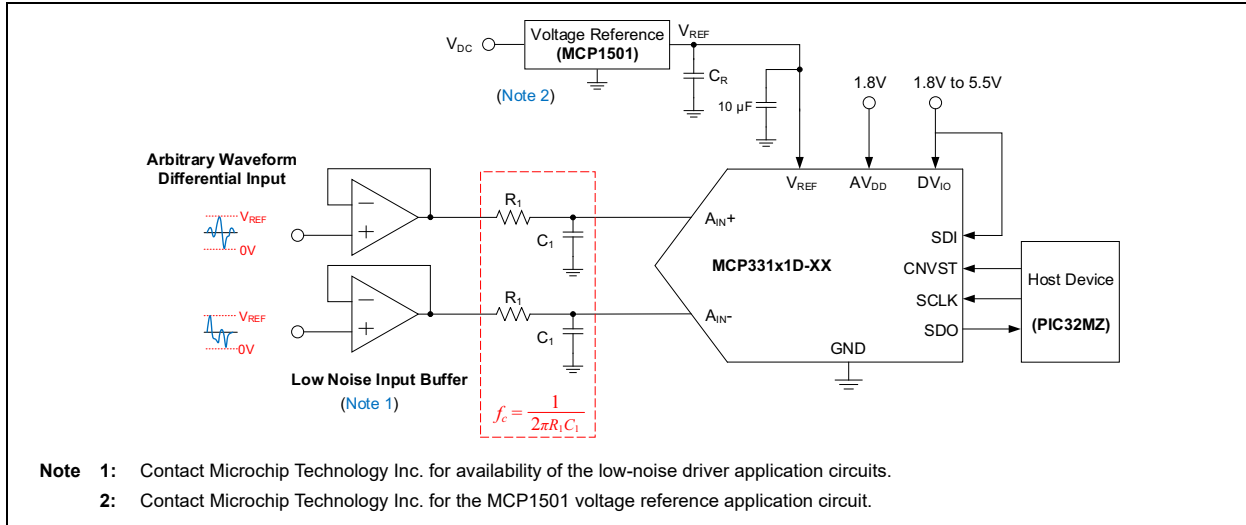

FIGURE 5-4: Input Configuration for Arbitrary Waveform Input Signals.

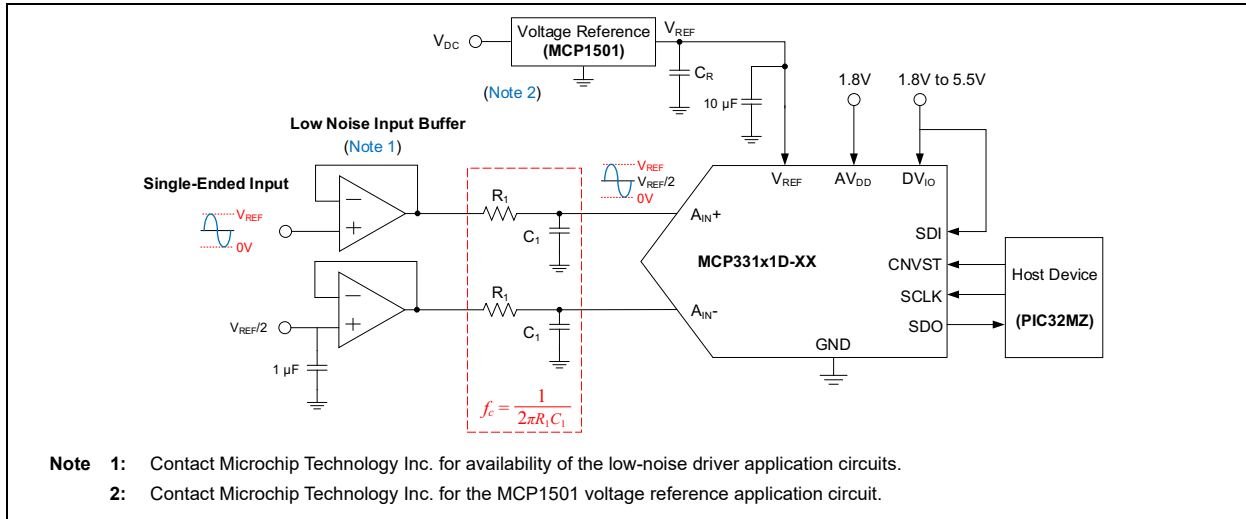

FIGURE 5-5: Pseudo-Differential Bipolar-Input Configuration for Single-Ended Input Signal.

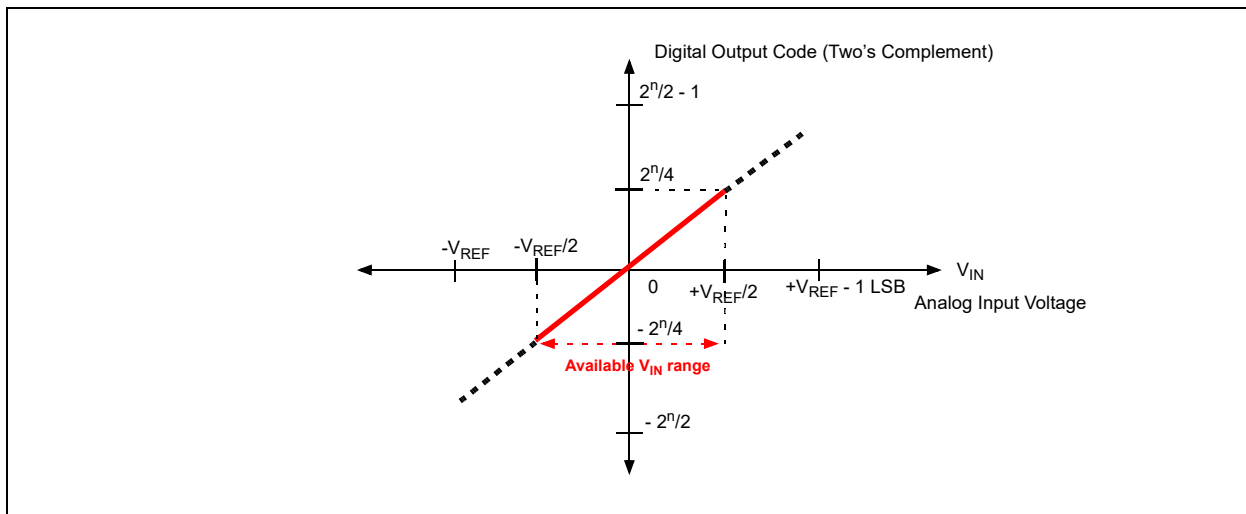

FIGURE 5-6: Transfer Function for Figure 5-5. See the output code example in Table 5-4.

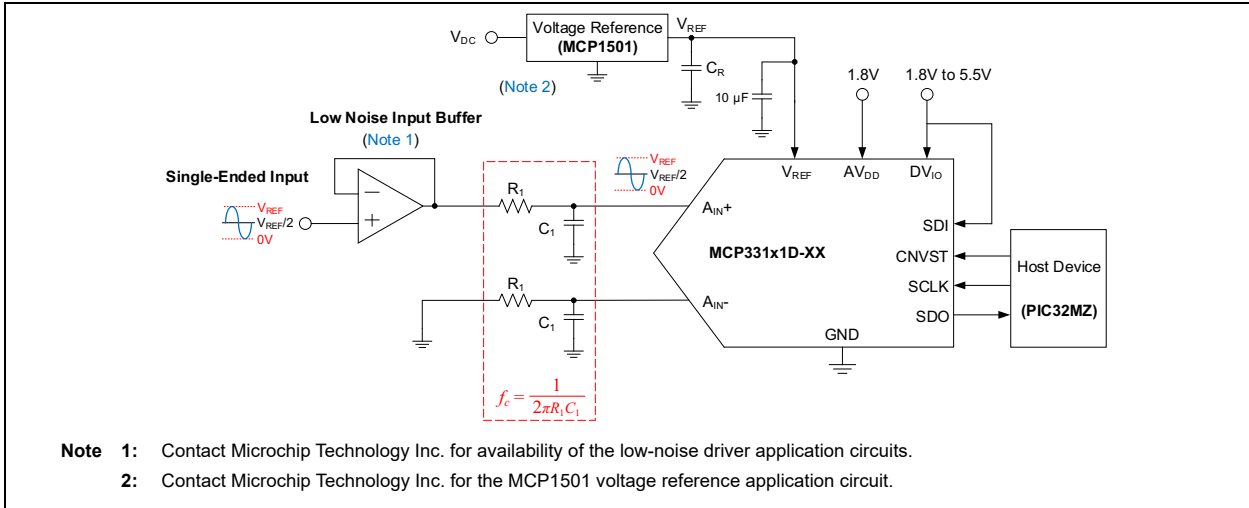

FIGURE 5-7: Pseudo-Differential Unipolar-Input Configuration for Single-Ended Input Signal.

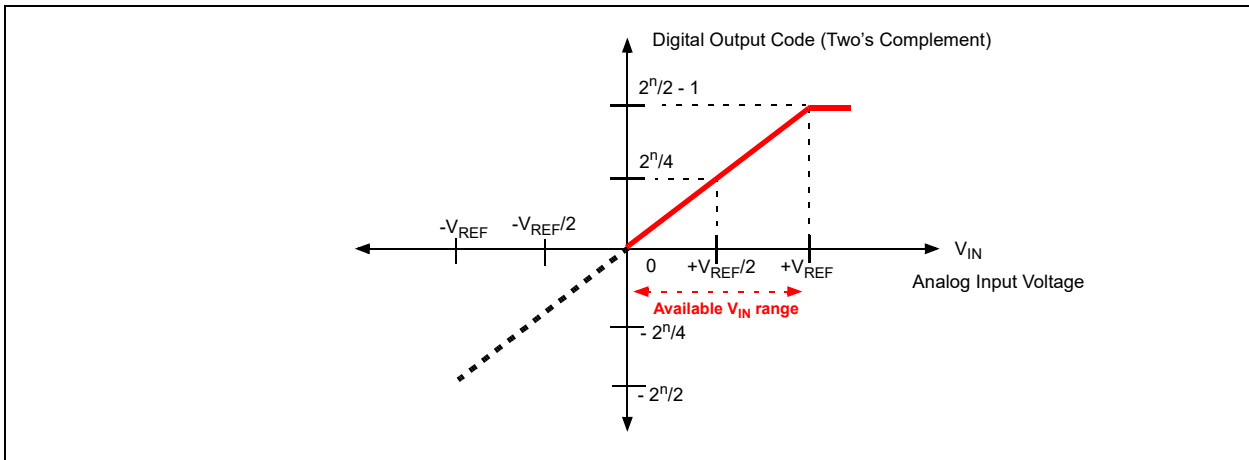

FIGURE 5-8: Transfer Function for Figure 5-7. See the output code example in Table 5-5.

Note: For measuring single-ended input signals, consider using Microchip's single-ended ADC devices such as the MCP33131-XX, MCP33151-XX or MCP33141-XX.

MCP33151D/41D-XX

5.3 ADC Input Driver Selection

The noise and distortion of the ADC input driver can degrade the dynamic performance (SNR, SFDR, and THD) of the overall ADC application system. Therefore, the ADC input driver needs better performance specifications than the ADC itself. The data sheet of the driver typically shows the output noise voltage and harmonic distortion parameters.

Figure 5-9 shows a simplified system noise presentation block diagram for the front-end driver and ADC.

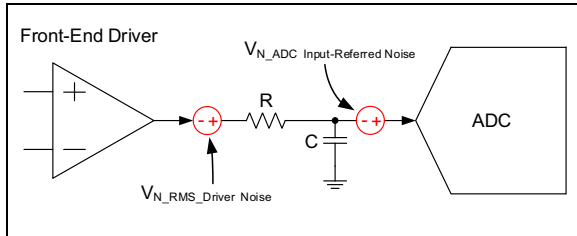

FIGURE 5-9: Simplified System Noise Representation.

- **Unity Gain Bandwidth:**

An input driver with higher bandwidth usually results in better overall linearity performance. Typically, the driver should have the unity gain bandwidth greater than 5 times the -3 dB cutoff frequency of the anti-aliasing filter:

EQUATION 5-3: BANDWIDTH REQUIREMENT FOR ADC INPUT DRIVER

$$BW_{Input\ Driver} \geq 5 \times f_B \quad (\text{Hz})$$

$$\geq \frac{5}{2\pi RC} \quad , \text{ for a single-pole RC filter.}$$

Where:

$$f_B = \text{-3 dB bandwidth of RC anti-aliasing filter, as shown in Figure 5-9.}$$

- **Distortion:**

The nonlinearity characteristics of the input driver cause distortions in the ADC output. Therefore, the input driver should have less distortion than the ADC itself. The recommended total harmonic distortion (THD) of the driver is at least 10 dB less than that of the ADC:

EQUATION 5-4: RECOMMENDED THD FOR ADC INPUT DRIVER

$$THD_{Input\ Driver} \leq THD_{ADC} - 10 \quad (\text{dB})$$

- **ADC Input-Referred Noise:**

When the ADC is operating with a full-scale input range, the ADC input-referred RMS noise is approximated as shown in Equation 5-5:

EQUATION 5-5: ADC INPUT-REFERRED NOISE

$$V_{N_ADC} \text{ Input-Referred Noise (V)}$$

$$= \frac{FSR}{2\sqrt{2}} 10^{-\frac{SNR}{20}}$$

$$= \frac{V_{REF}}{\sqrt{2}} 10^{-\frac{SNR}{20}} \quad , \text{ for differential input;}$$

$$= \frac{V_{REF}}{2\sqrt{2}} 10^{-\frac{SNR}{20}} \quad , \text{ for single-ended input.}$$

Where FSR is the input full-scale range of the ADC.

- **Noise Contribution from the Front-End Driver:**

The noise from the input driver can degrade the ADC's SNR performance. Therefore, the selected input driver should have the lowest possible broadband noise density and 1/f noise. When an anti-aliasing filter is used after the input driver, the output noise density of the input driver is integrated over the -3 dB bandwidth of the filter.

Equation 5-6 shows the RMS output noise voltage calculation using the RC filter's bandwidth and noise density (e_N) of the input driver. G_N in Equation 5-6 is the noise gain of the driver amplifier and becomes 1 for a unity gain buffer driver.

EQUATION 5-6: NOISE FROM FRONT-END DRIVER AMPLIFIER

$$V_{N_RMS_Driver_Noise} = G_N \frac{e_N}{\sqrt{2}} \sqrt{\pi f_B} \quad (\text{V})$$

Where e_N is the broadband noise density (V/√Hz) of the front-end driver amplifier and is typically given in its data sheet.

In Equation 5-6, 1/f noise ($e_{N\text{Flicker}}$) is ignored assuming it is very small compared to the broadband noise (e_N).

For high precision ADC applications, the noise contribution from the front-end input driver amplifier is typically constrained to be less than about 20% (or 1/5 times) of the ADC input-referred noise as shown in Equation 5-7:

EQUATION 5-7: RECOMMENDED ADC INPUT DRIVER NOISE

$$V_{N_RMS_Driver_Noise} \leq \frac{1}{5} V_{N_ADC_Input-Referred_Noise}$$

Using Equation 5-5 to Equation 5-7, the recommended noise voltage density (e_N) limit of the ADC input driver is expressed in Equation 5-8:

EQUATION 5-8: NOISE DENSITY FOR ADC INPUT DRIVER

$$G_N \frac{e_N}{\sqrt{2}} \sqrt{\pi f_B} \leq \frac{1}{5} V_{N_ADC_Input_Referred_Noise}$$

(a) e_N for differential input ADC:

$$e_N \leq \frac{1}{5G_N} \frac{1}{\sqrt{\pi f_B}} V_{REF} 10^{\frac{SNR}{20}} \left(\frac{V}{\sqrt{Hz}} \right)$$

(a) e_N for single-ended input ADC:

$$e_N \leq \frac{1}{10G_N} \frac{1}{\sqrt{\pi f_B}} V_{REF} 10^{\frac{SNR}{20}} \left(\frac{V}{\sqrt{Hz}} \right)$$

Using Equation 5-8, the recommended maximum noise voltage density limit for unity gain input driver for differential input ADC can be estimated. Table 5-1 and Table 5-2 show a few example results with $G_N = 1$. These tables may be used as a reference when selecting the ADC input driver amplifier.

TABLE 5-1: NOISE VOLTAGE DENSITY (E_N) OF INPUT DRIVER FOR MCP33151D-XX

ADC (Note 1)			RC Filter	ADC Input Driver Amplifier ($G_N = 1$)
V_{REF}	SNR (dBFS)	ADC Input-Referred Noise	fB (Note 2)	Noise Voltage Density (e_N)
1.8V	78.8	146 μ V	3 MHz	13.5 nV/ \sqrt{Hz}
			4 MHz	11.7 nV/ \sqrt{Hz}
			5 MHz	10.4 nV/ \sqrt{Hz}
3V	81.8	172 μ V	3 MHz	15.9 nV/ \sqrt{Hz}
			4 MHz	13.8 nV/ \sqrt{Hz}
			5 MHz	12.3 nV/ \sqrt{Hz}
5V	83.7	231 μ V	3 MHz	21.3 nV/ \sqrt{Hz}
			4 MHz	18.4 nV/ \sqrt{Hz}
			5 MHz	16.5 nV/ \sqrt{Hz}

- Note 1:** See Equation 5-5 for the ADC input-referred noise calculation for differential input.
- 2:** f_B is -3dB bandwidth of the RC anti-aliasing filter.

TABLE 5-2: NOISE VOLTAGE DENSITY (e_N) OF INPUT DRIVER FOR MCP33141D-XX

ADC (Note 1)			RC Filter	ADC Input Driver Amplifier ($G_N = 1$)
V_{REF}	SNR (dBFS)	ADC Input-Referred Noise	fB (Note 2)	Noise Voltage Density (e_N)
1.8V	72	319.7 μ V	3 MHz	29.5 nV/ \sqrt{Hz}
			4 MHz	25.5 nV/ \sqrt{Hz}
			5 MHz	22.8 nV/ \sqrt{Hz}
3V	73.6	443.2 μ V	3 MHz	40.8 nV/ \sqrt{Hz}
			4 MHz	35.4 nV/ \sqrt{Hz}
			5 MHz	31.6 nV/ \sqrt{Hz}
5V	73.8	721.9 μ V	3 MHz	66.5 nV/ \sqrt{Hz}
			4 MHz	57.6 nV/ \sqrt{Hz}
			5 MHz	51.5 nV/ \sqrt{Hz}

- Note 1:** See Equation 5-5 for the ADC input-referred noise calculation for differential input.
- 2:** f_B is -3dB bandwidth of the RC anti-aliasing filter.

MCP33151D/41D-XX

5.4 Device Operation

When the MCP33151D/41D-XX is first powered-up, it self-calibrates internal systems and automatically enters Input Acquisition mode. The device operates in two phases: **(a)** Input Acquisition (Standby) and **(b)** Data Conversion. Figure 5-10 shows the ADC's operating sequence.

5.4.1 INPUT ACQUISITION PHASE (STANDBY)

During the input acquisition phase (t_{ACQ}), also called Standby, the two input sampling capacitors, C_S^+ and C_S^- , are connected to the A_{IN}^+ and A_{IN}^- pins, respectively. The input voltage is sampled until a rising edge on CNVST is detected. The input voltage should be fully settled within 1/2 LSB during t_{ACQ} .

The acquisition time (t_{ACQ}) is user-controllable. The system designer can increase the acquisition time (t_{ACQ}) as much as needed to reduce sampling rate for additional power savings.

5.4.2 DATA CONVERSION PHASE

The start of the conversion is controlled by CNVST. On the rising edge of CNVST, the sampled charge is locked (sample switches are opened) and the ADC performs the conversion. Once a conversion is started, it will not stop until the current conversion is complete. The data conversion time (t_{CNV}) is not user controllable. After the conversion is complete and the host lowers CNVST, the output data is presented on SDO.

Any noise injection during the conversion phase may affect the accuracy of the conversion. To reduce external environment noise, minimize I/O events and running clocks during the conversion time.

The output data is clocked out MSB first. While the output data is being transferred, the device enters the next input acquisition phase.

Note: Transferring output data during the acquisition phase can disturb the next input sample. It is highly recommended to allow at least t_{QUIET} (10 ns, typical) between the last edge on the SPI interface and the rising edge on CNVST. See Figure 1-1 for t_{QUIET} .

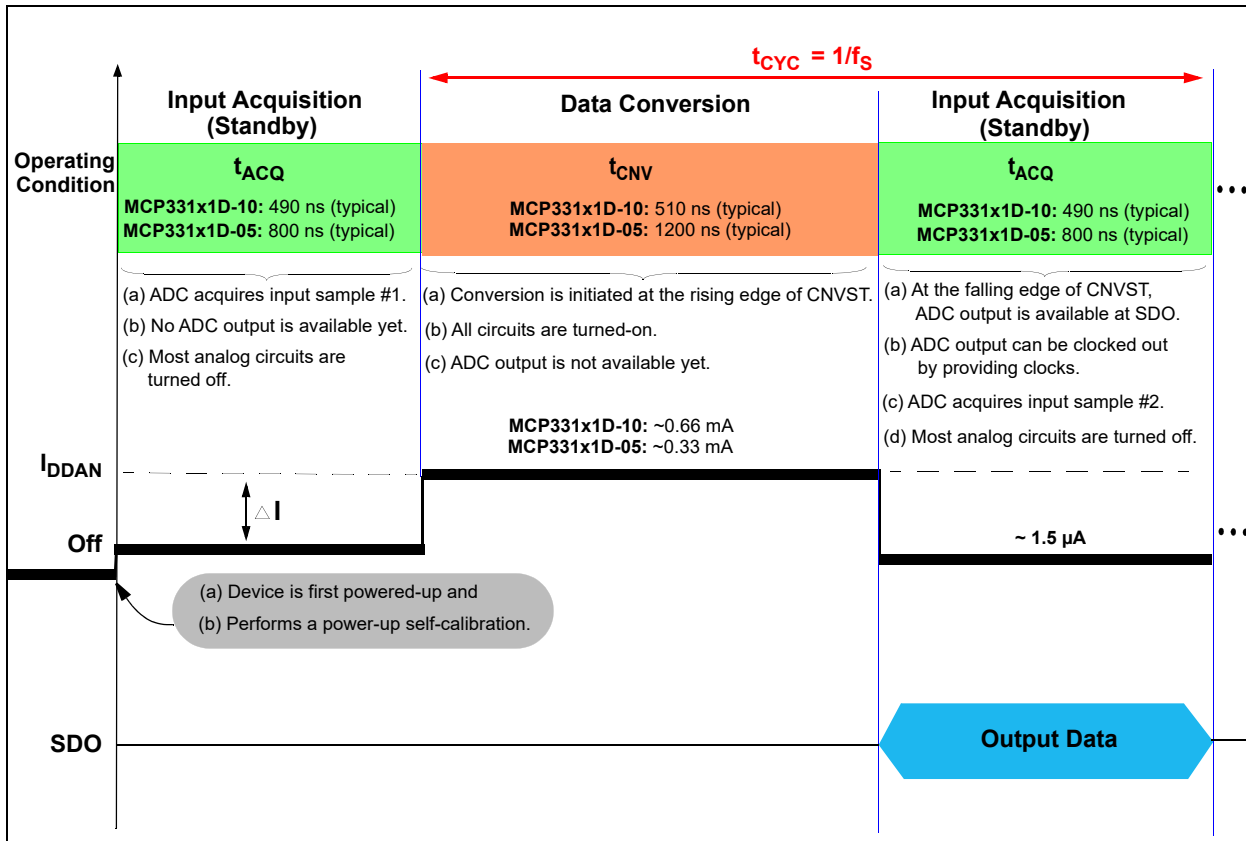

FIGURE 5-10: Device Operating Sequence.

5.4.3 SAMPLE THROUGHPUT RATE

The device completes data conversion within the maximum specification of the data conversion time (t_{CNV}). The continuous input sample rate is the inverse of the sum of input acquisition time (t_{ACQ}) and data conversion time (t_{CNV}). Equation 5-9 shows the continuous sample rate calculation using the minimum and maximum specifications of the input acquisition time (t_{ACQ}) and data conversion time (t_{CNV}).

EQUATION 5-9: SAMPLE RATE

$$\text{Sample Rate} = \frac{1}{(t_{ACQ} + t_{CNV})}$$

(a) MCP331X1D-10:

$$\text{Sample Rate} = \frac{1}{(250 \text{ ns} + 750 \text{ ns})} = 1 \text{ Msps}$$

(b) MCP331X1D-05:

$$\text{Sample Rate} = \frac{1}{(600 \text{ ns} + 1400 \text{ ns})} = 500 \text{ kSPS}$$

5.4.4 SERIAL SPI CLOCK FREQUENCY REQUIREMENT

The ADC output is collected during the input acquisition time (t_{ACQ}). For continuous input sampling and data conversion sequence, the SPI clock frequency should be fast enough to clock out all output data bits during the input acquisition time (t_{ACQ}). For the continuous sampling rate (f_S), the minimum SPI clock frequency requirement is determined by Equation 5-10:

EQUATION 5-10: SPI CLOCK FREQUENCY REQUIREMENT

$$t_{ACQ} = N \times T_{SCLK} + t_{QUIET} + t_{EN}$$

$$f_{SCLK} = \frac{1}{T_{SCLK}} = \frac{N}{t_{ACQ} - (t_{QUIET} + t_{EN})}$$

Where:

- f_{SCLK} = minimum SPI serial clock frequency required to transfer all N-bits of output data during t_{ACQ}
- N = number of output data bits
- T_{SCLK} = Period of SPI clock
- $N \times T_{SCLK}$ = Output data window
- t_{QUIET} = Quiet time between the last output bit and beginning of the next conversion start
 - = 10 ns (Min.)
- t_{EN} = Output enable time
 - = 10 ns (Max.) with DVIO \geq 2.3V

Note: Refer to [Serial Interface Timing Specifications](#) for relevant timing information and see [Figure 1-1](#) for interface timing diagram.

5.4.5 SERIAL SPI CLOCK FREQUENCY REQUIREMENT

The ADC output is collected during the input acquisition time (t_{ACQ}). For continuous input sampling and data conversion sequence, the SPI clock frequency should be fast enough to clock out all output data bits during the input acquisition time (t_{ACQ}). For the continuous sampling rate (f_S), the minimum SPI clock frequency requirement is determined by Equation 5-10:

MCP33151D/41D-XX

5.5 Transfer Function

The differential analog input is $V_{IN} = (V_{IN+}) - (V_{IN-})$. The LSB size is given by Equation 5-11, and an example of LSB size vs. reference voltage is summarized in Table 5-3.

EQUATION 5-11: LSB SIZE (EXAMPLE)

$$LSB = \frac{2V_{REF}}{2^N}$$

Where N is the resolution of the ADC in bits.

TABLE 5-3: LSB SIZE VS. REFERENCE

Reference Voltage (V_{REF})	LSB Size	
	MCP33151D-XX (14-bit)	MCP33141D-XX (12-bit)
1.8V	219.7 μ V	879.8 μ V
2V	244 μ V	976.6 μ V
2.5V	305.2 μ V	1.2207 mV
3V	366.2 μ V	1.4648 mV
3.3V	402.8 μ V	1.6113 mV
3.5V	427.3 μ V	1.7090 mV
4V	488.3 μ V	1.9531 mV
4.5V	549.3 μ V	2.1973 mV
5V	610.4 μ V	2.4414 mV
5.1V	622.6 μ V	2.4902 mV

Figure 5-11 shows the ideal transfer function and Table 5-4 shows the digital output codes for the MCP33151D/41D-XX.

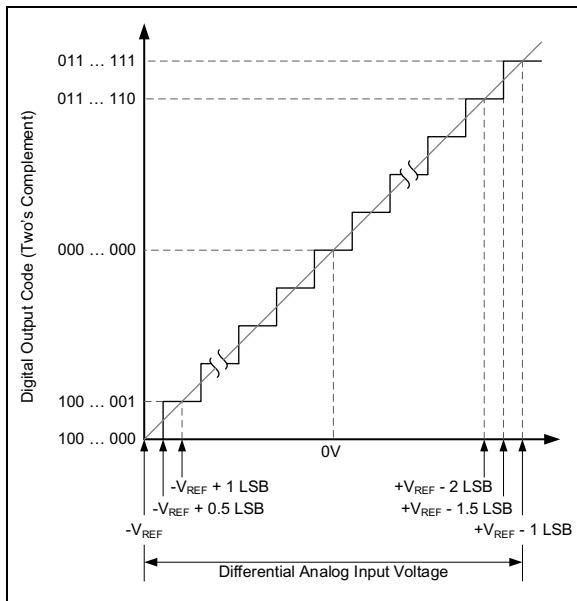

FIGURE 5-11: Ideal Transfer Function for Fully-Differential Input Signal.

5.6 Digital Output Codes

5.6.1 DIGITAL OUTPUT CODE FOR DIFFERENTIAL INPUT CONFIGURATIONS (See Figure 5-2 to Figure 5-6)

The digital output code is proportional to the input voltage. The output data is in two's complement format. With this coding scheme the MSB can be considered a sign indicator. When the MSB is a logic '0', the input is positive. When the MSB is a logic '1', the input is negative. The following is an example of the output code:

(a) for a negative full-scale input:

Analog Input: $(V_{IN+}) - (V_{IN-}) = -V_{REF}$

Output Code: 1000...0000

(b) for a zero differential input:

Analog Input: $(V_{IN+}) - (V_{IN-}) = 0V$

Output Code: 0000...0000

(c) for a positive full-scale input:

Analog Input: $(V_{IN+}) - (V_{IN-}) = +V_{REF}$

Output Code: 0111...1111

The MSB (sign bit) is always transmitted first through the SDO pin.

The code will be locked at 0111...11 for all voltages greater than $(V_{REF} - 1 \text{ LSB})$ and 1000...00 for voltages less than $-V_{REF}$. Table 5-4 shows an example of output codes of various input levels.

Note: Collect the output code at SDO on the falling edge of SCLK pulse.

TABLE 5-4: DIGITAL OUTPUT CODE (See Figure 5-2 to Figure 5-6)

Input Voltage (V)	Digital Output Codes	
	MCP33151D-XX (14-bit)	MCP33141D-XX (12-bit)
V_{REF}	01-1111-1111-1111	0111-1111-1111
$V_{REF} - 1 \text{ LSB}$	01-1111-1111-1111	0111-1111-1111
.	.	.
2 LSB	00-0000-0000-0010	0000-0000-0010
1 LSB	00-0000-0000-0001	0000-0000-0001
0V	00-0000-0000-0000	0000-0000-0000
-1 LSB	11-1111-1111-1111	1111-1111-1111
-2 LSB	11-1111-1111-1110	1111-1111-1110
.	.	.
$-V_{REF}$	10-0000-0000-0000	1000-0000-0000
$< -V_{REF}$	10-0000-0000-0000	1000-0000-0000

5.6.2 DIGITAL OUTPUT CODE FOR SINGLE-ENDED INPUT CONFIGURATION (See Figure 5-7)

The MCP33151D/MCP33141D-XX are designed for a differential input configuration; therefore, it computes a sign-bit. When a single-ended input configuration is used as shown in Figure 5-7, the input is always unipolar and above the GND level. Because of this, the

sign-bit (MSB) must be ignored and the remaining bits are used as straight binary code. Table 5-5 shows the output code example when the input is configured as a pseudo-differential unipolar-input for a single-ended input signal as shown in Figure 5-7. Note that the LSB is computed using the same equation in Equation 5-11.

TABLE 5-5: DIGITAL OUTPUT CODE FOR SINGLE-ENDED INPUT (See Figure 5-7)

Input Voltage (V)	Digital Output Codes	
	MCP33151D-XX (14-bit)	MCP33141D-XX (12-bit)
V_{REF}	X1-1111-1111-1111	X111-1111-1111
$V_{REF} - 1 \text{ LSB}$	X1-1111-1111-1111	X111-1111-1111
.	.	.
2 LSB	X0-0000-0000-0010	X000-0000-0010
1 LSB	X0-0000-0000-0001	X000-0000-0001
$\leq 0V$	X0-0000-0000-0000	X000-0000-0000

Note: X in MSB is a do not care bit and needs to be ignored in computation.

MCP33151D/41D-XX

5.7 Data Accumulator

The MCP33151D/41D-XX devices feature an internal integrator capable of accumulating consecutive sample data and transmitting the accumulated data directly from the ADC, without requiring any special SPI settings to operate. This enables the user to achieve a higher ENOB through consecutive sample integration utilizing the ADC hardware, without requiring any external computational resources and reducing the amount of data transmitted on the serial bus. See [Figure 5-12](#) for an example FFT performance plot after 1024 integrated samples while sampling a 75Hz input signal with a 5V reference voltage. Refer to [Figure 5-13](#) for an example of FFT performance across possible integration lengths.

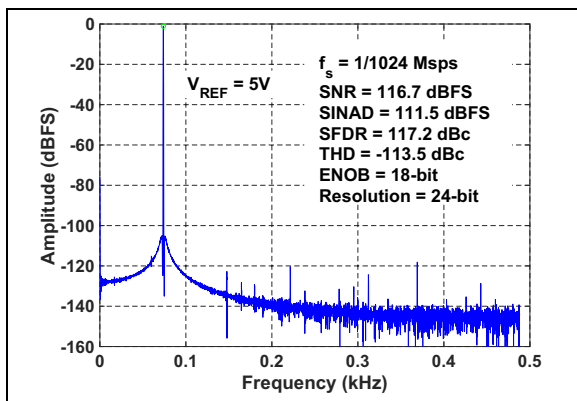

FIGURE 5-12: FFT with 1024 integrated samples: Input Freq = 75Hz.

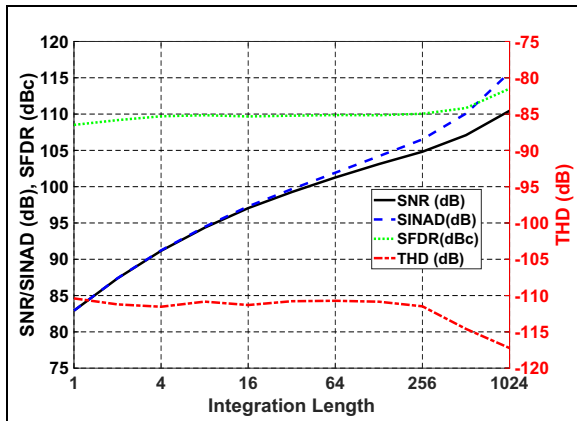

FIGURE 5-13: FFT with 1024 integrated samples: Input Freq = 75Hz.

5.7.1 DATA ACCUMULATOR USAGE

Data accumulation is performed automatically within the device between each sequential Conversion/Acquisition cycle (TCYC) whenever the current conversion results are not read out, up to a total of 1024 consecutive conversions for an ENOB increase of up to 5 bits above typical. To begin data accumulation, the user simply avoids transmitting any

SCLK pulses during each sequential conversion cycle.

Note: If a sample has been converted but not read out, the sample can be discarded by providing at least 1 SCLK pulse before initiating the next conversion. Providing at least 1 SCLK will reset the system for single acquisition. Otherwise all consecutive conversions without an SCLK pulse will automatically be integrated with the previous conversion results.

After completing the desired number of conversions to achieve the target ENOB, the user can begin transferring the total accumulated data by transmitting the necessary number of SCLK pulses to transfer all stored bits. Refer to [Table 5-5](#) for number of conversions, bit size and ENOB relationship. See [Figure 6-5](#) and [Figure 6-8](#) for example Conversion/Acquisition control and SPI timing operation.

Consecutive sample integration increases the bit size of the output data, up to the maximum output size of the ADC (24-bits / 18.5 ENOB at 1024 samples for a 14-bit ADC).

Because the addition of two binary values can produce a sum with an increased bit size, the ADC will need to output data proportional to the amount of samples being integrated. See [Table 5-5](#) for an estimate of the data size and ENOB capability depending on the number of conversions the user chooses to integrate.

When using the accumulator, it is important to consider the frequency content of the input signal being sampled. Because the accumulator is averaging all consecutive conversions over the accumulated time period, the input frequency must be low enough to ensure that no signal information is being filtered out. This means that there is a performance trade-off between sample integration length (and resulting ENOB improvement) and the maximum input frequency that can be sampled. Refer to [Table 5-6](#) to understand the roll-off frequencies for various integration lengths, and refer to [Figure 5-14](#) for an example of the dB attenuation across integration lengths.

TABLE 5-5: ACCUMULATED DATA SIZE AND ENOB FOR 14-BIT ADC

Number of Conversions	ADC transmission size (bits)	Effective Number of bits (ENOB) (1)
1	14	13.5
2	15	14
3 - 4	16	14 - 14.5
5 - 8	17	14.5 - 15
9 - 16	18	15 - 15.5
17 - 32	19	15.5 - 16

Number of Conversions	ADC transmission size (bits)	Effective Number of bits (ENOB) (1)
33 - 64	20	16 - 16.5
65 - 128	21	16.5 - 17
129 - 256	22	17 - 17.5
257 - 512	23	17.5 - 18
513 - 1024	24	18 - 18.5

Note 1: ENOB values based on typical 14b device characteristics under nominal conditions and setting N to the maximum value in the corresponding row.

Note: The discrepancy between the output data size and the actual ENOB is a result of sample integration doubling both the signal amplitude and the noise power for each factor of two that the samples are integrated. By integrating 2 samples, the signal amplitude increases SNR by 6 dB, and the noise power decreases SNR by 3 dB, resulting in an overall SNR increase of 3 dB (+0.5 ENOB).

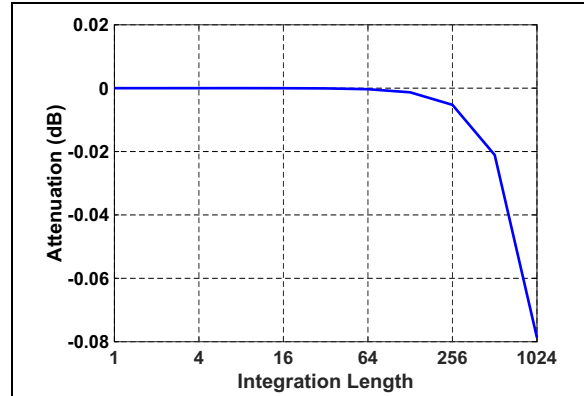

FIGURE 5-14: Measured Attenuation of Fundamental Frequency (dB) vs Integration Length: Input Freq = 75 Hz.

TABLE 5-6: INPUT SIGNAL ROLL-OFF FREQUENCY VS INTEGRATION LENGTH

Integration Length	Roll-Off (Hz @ 1MSPS)		
	0.1 dB	0.01 dB	0.001 dB
2	41781.9	13226.3	4183.0
4	20890.9	6613.2	2091.5
8	10445.5	3306.6	1045.7
16	5222.7	1653.3	522.9
32	2611.4	826.6	261.4
64	1305.7	413.3	130.7
128	652.8	206.7	65.4
256	326.4	103.3	32.7
512	163.2	51.7	16.3
1024	81.6	25.8	8.2

MCP33151D/41D-XX

6.0 DIGITAL SERIAL INTERFACE

The device has an SPI compatible serial digital interface using four digital interface pins: CNV, SDI, SDO and SCLK.

The following sections describe the operation of the MCP33151D/41D-XX using the digital serial interface.

Table 6-1 summarizes the descriptions of both digital interface pins and interface options, respectively. The communication is always started by the host device (Master).

Note: This device supports a standard SPI Mode 0,0 only.
SPI MODE 0,0: In this mode, the SCLK Idle state is “Low”. Data is clocked out on the SDO pin on the falling edge of the SCLK pin.
 For the MCP33151D/41D-XX, this means that there will be a rising edge before there is a falling edge.

6.1 Serial Interface Options and Serial Communications

The device offers a \overline{CS} mode with 3-wire interface, and can operate either with or without a BUSY indicator status output. This BUSY status output bit is followed by the conversion output bits, and can be used as an interrupt request (\overline{IRQ}) input for the digital host device.

The 3-Wire \overline{CS} mode (using CNV, SCLK, SDO) interface is simple and useful when the host device handles a single MCP33151D/41D-XX device.

The following sections detail the serial communication of the 3-Wire \overline{CS} modes with or without a BUSY output.

TABLE 6-1: INTERFACE MODE SELECTION SUMMARY

Interface Mode	SDI Pin		CNV Pin at t_{CNV} (recommended)	SCLK at CNV Rising Edge	BUSY bit at SDO
	At CNV Rising Edge	After CNV Rising Edge			
3-Wire \overline{CS} Mode without BUSY output bit	“High”		Transition from “High” to “Low” after t_{CNV} (Max)	—	No
3-Wire \overline{CS} Mode with BUSY output bit	“Low”		Transition from “High” to “Low” before t_{CNV} (Max)	—	Yes

6.1.1 \overline{CS} MODES

Note: The timing diagram examples in the following subsections are shown for 14-bit mode only. The examples are applicable for 12-bit mode in the same way with reduced bits.

6.1.1.1 3-Wire \overline{CS} MODE WITHOUT BUSY OUTPUT BIT

This interface option is most useful when a single MCP33151D/41D-XX is connected to an SPI-compatible digital host. Figure 6-1 shows the connection diagram with the host device. In this mode, CNV functions as both conversion control and chip select (\overline{CS}).

To enable this interface option, SDI can either be tied to V_{IO} , or otherwise permanently held in a Logic = 1 state. By doing so, the device will never output a BUSY status bit.

As shown in Figure 6-2, at the rising edge of CNV, the conversion is initiated. The SDO pin becomes high-Z state (if no external pull-up is used). Once the conversion is initiated, it continues and the ADC

completes the conversion regardless of the state of the CNV pin. This means the CNV pin can be used for other SPI devices after the conversion is initiated.

When conversion is complete, the device enters the acquisition phase (Power-Down state), and SDO comes out of the high-Z state when CNV is lowered. The device exits the acquisition phase when CNV goes “High”. SDO returns to a high-Z state after the 14th SCLK falling edge or when CNV goes high, whichever occurs first.

The device will output the MSB on the SDO pin following the falling edge of CNV, or once the Converting Phase (t_{CNV}) completes, whichever happens later. The remaining data bits are then clocked out on the subsequent SCLK falling edges. A digital host collects the data (SDO) on the falling edge of SCLK.

It is recommended to use this mode only when the ADC Converting Phase (t_{CNV}) will complete before the falling edge of CNV.

Figure 6-2 and Figure 6-3 show the timing diagrams for both early and late CNV lowering scenarios.

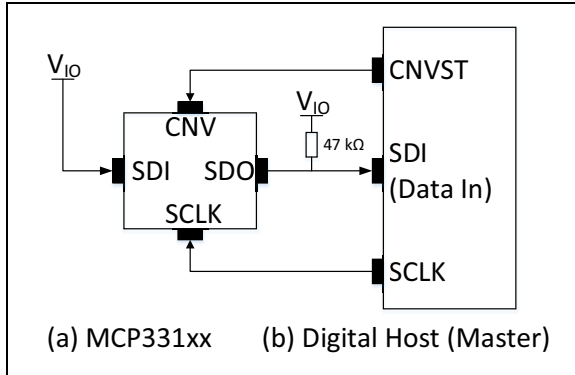

FIGURE 6-1: Connection Diagram for 3-Wire \overline{CS} Mode without *BUSY* Status Indicator Output Bit.

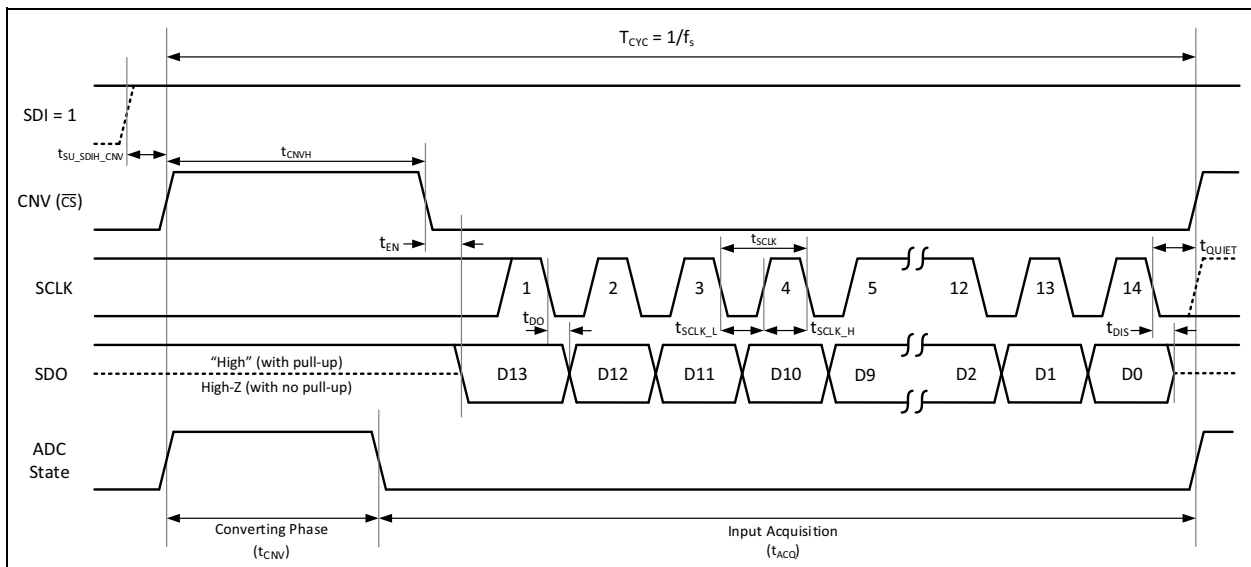

FIGURE 6-2: Interface Timing Diagram for 3-Wire \overline{CS} Mode without *BUSY* Status Indicator Output Bit, Late CNV (Recommended).

MCP33151D/41D-XX

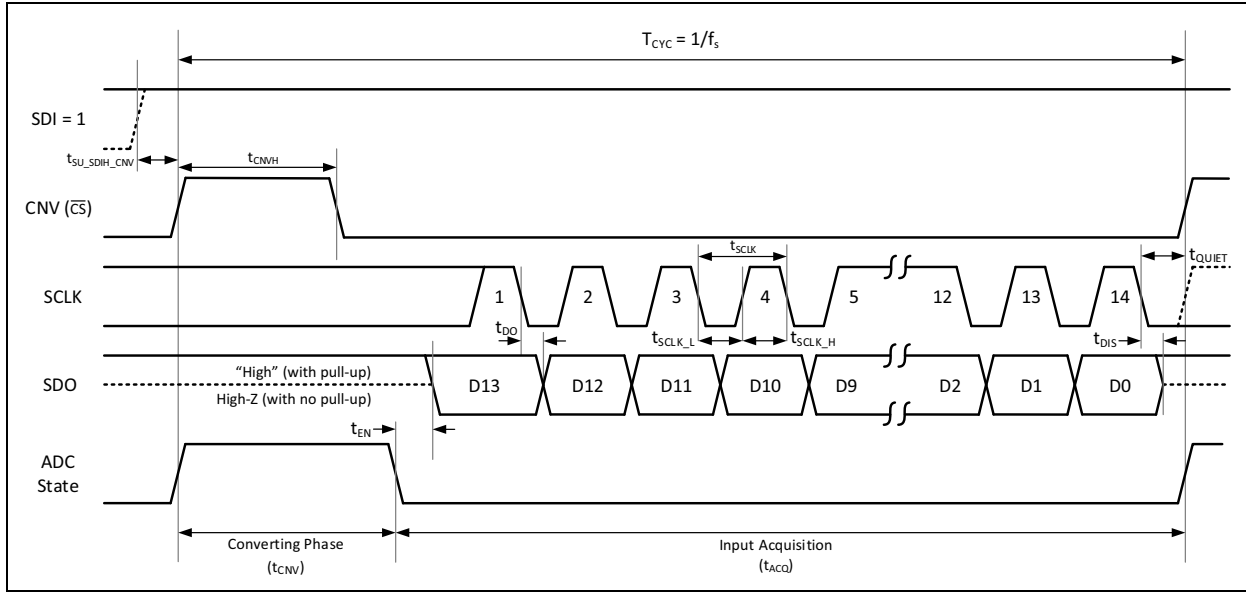

FIGURE 6-3: Interface Timing Diagram for 3-Wire $\overline{\text{CS}}$ Mode without BUSY Status Indicator Output Bit, Early CNV.

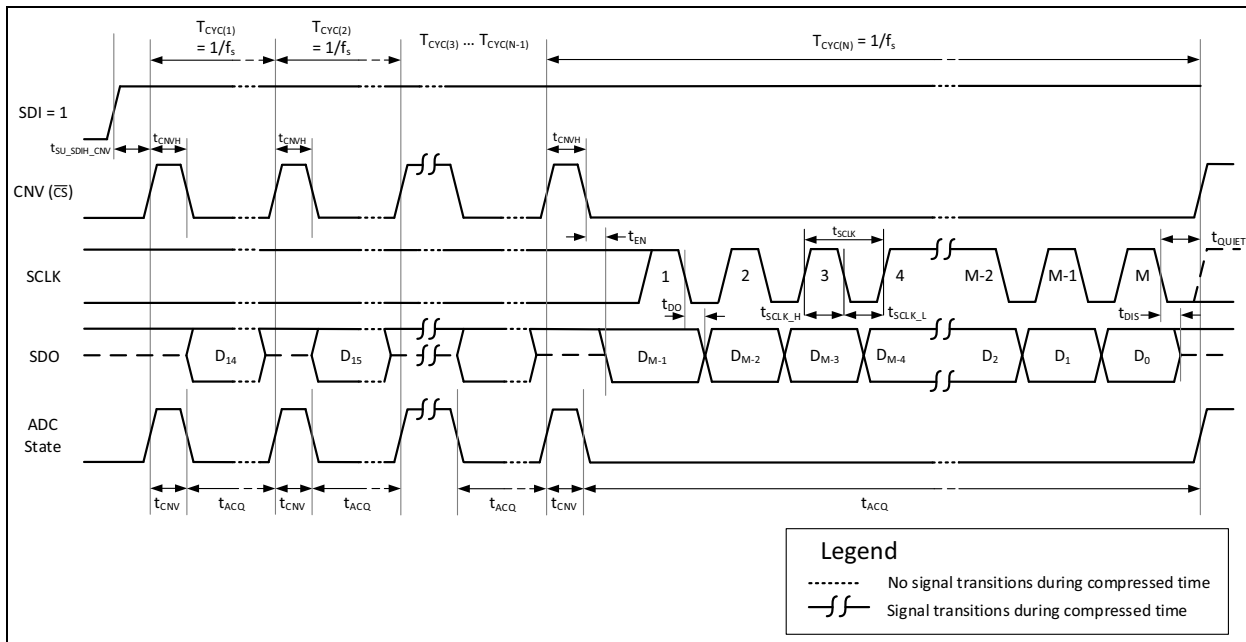

FIGURE 6-4: Interface Timing Diagram for Accumulator Operation in 3-Wire $\overline{\text{CS}}$ Mode without BUSY Status Indicator Output Bit.

Note: Refer to [Section 5.7, Data Accumulator](#) for more details about using the data accumulator feature.

6.1.1.2 3-Wire \overline{CS} Mode with BUSY Output Bit

This interface option is typically used when a single MCP33151D/41D-XX is connected to an SPI-compatible digital host that has an interrupt (IRQ) input.

Figure 6-5 shows the connection diagram with the host device. In this mode, CNV functions as both conversion control and chip select (\overline{CS}).

To enable this interface option, SDI can either be tied to GND, or otherwise permanently held in a Logic = 0 state. By doing so, the device will output a BUSY bit before each conversion data sample.

As shown in Figure 6-6, at the rising edge of CNV, conversion is initiated. The SDO pin becomes high-Z state (if no external pull-up is used). Once the conversion is initiated, it continues and the ADC completes the conversion regardless of the state of the CNV pin. This means the CNV pin can be used for other SPI devices after the conversion is initiated.

When conversion is complete, the device enters an acquisition phase and Power-Down state, SDO comes out of the high-Z state, and outputs a BUSY status indicator bit (“Low” level). The device exits the acquisition phase when CNV once again returns to a “High” state. SDO then returns to a high-Z state after the 15th SCLK falling edge or when CNV goes high, whichever occurs first.

Note: It is recommended that CNV be driven low before the minimum conversion time (t_{CNV}) expires, and remain “Low” until the maximum possible conversion time (t_{CONV}) expires. A “Low” level on the CNV input at the end of a conversion ensures the device generates a BUSY status indicator bit when the ADC has finished converting.

This configuration provides a high-to-low transition on the IRQ pin of the digital host caused by the BUSY bit. The data bits are clocked out, MSB first, on the subsequent SCLK falling edges. Data are valid on both edges of SCLK and can be captured on either edge. However, a digital host capturing data on the SCLK falling edge can achieve a faster reading rate.

Figure 6-6 and Figure 6-7 show the timing diagrams for both early and late CNV lowering scenarios.

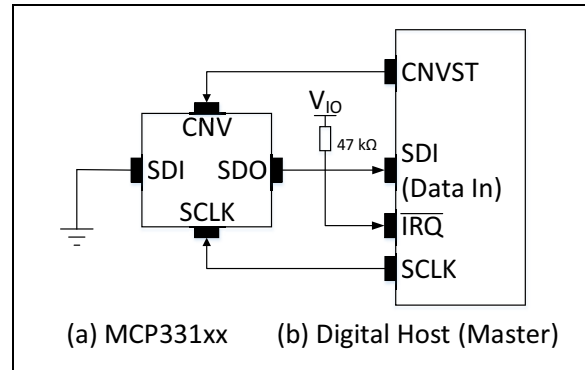

FIGURE 6-5: Connection Diagram for 3-Wire \overline{CS} Mode with BUSY Status Indicator Output Bit. IRQ Pin in the Host Device Is Used for Interrupt Event.

Note: The pull-up resistor on the SDO pin is required in this mode as it ensures that the IRQ pin of the digital host is held high when SDO goes to high-Z state.

MCP33151D/41D-XX

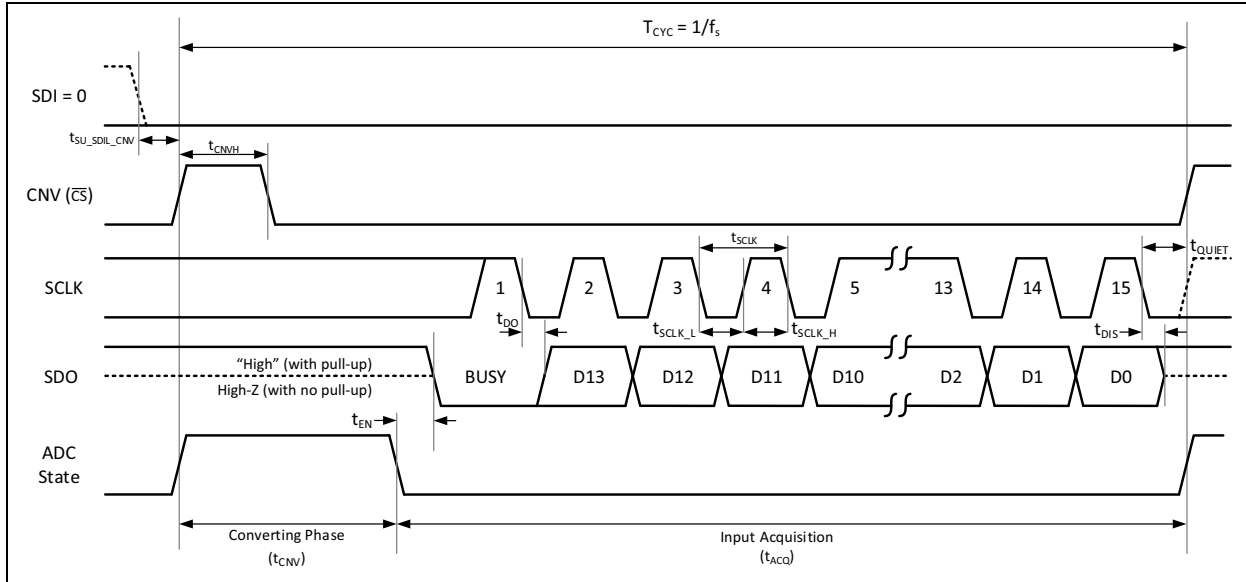

FIGURE 6-6: Timing Diagram for 3-Wire \overline{CS} Mode with *BUSY* Status indicator Output Bit, Early CNV (Recommended).

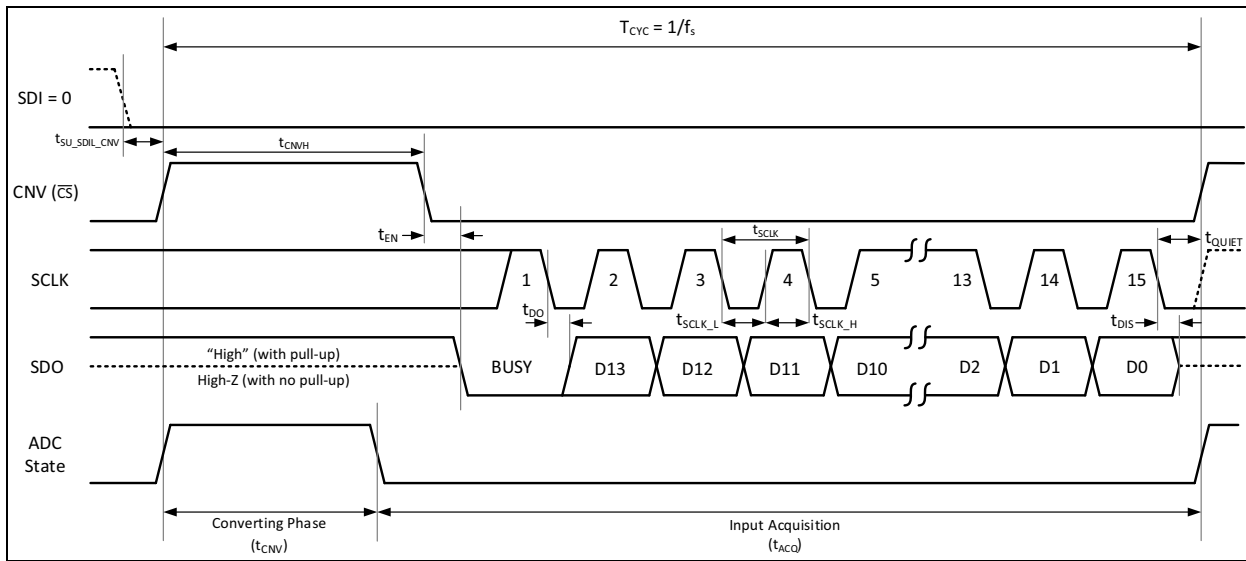

FIGURE 6-7: Timing Diagram for 3-Wire \overline{CS} Mode with *BUSY* Status Indicator Output Bit, Late CNV.

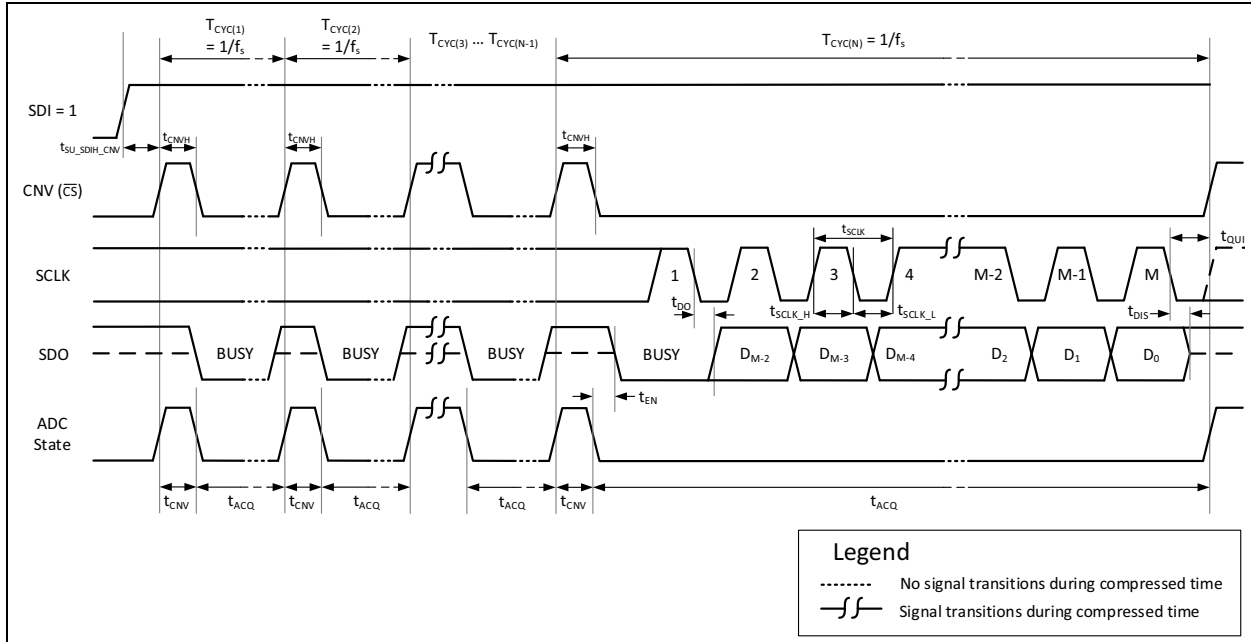

FIGURE 6-8: Timing Diagram for Accumulator Operation in 3-Wire \overline{CS} Mode with **BUSY** Status Indicator Output Bit.

Note: Refer to [Section 5.7, Data Accumulator](#) for more details about using the data accumulator feature.

MCP33151D/41D-XX

6.2 Recalibrate Command

The recalibrate command may be used in the following cases:

- When the reference voltage was not fully settled during the initial power-on sequence.
- During operation, to ensure optimum performance across varying environment conditions, such as reference voltage and temperature.

A self-calibration is initiated by sending the recalibrate command. The host device sends a recalibrate command by transmitting 1024 SCLK pulses (including the clocks for data bits) while the device is in the acquisition phase (Standby).

The device drives SDO low during the recalibration procedure, and returns to high-Z once completed. The status of the recalibration procedure can be monitored by placing a pull-up on SDO, so that SDO goes high when the recalibration is complete.

Figure 6-9 shows the recalibrate command timing diagram. The calibration takes approximately 500 ms (t_{CAL}).

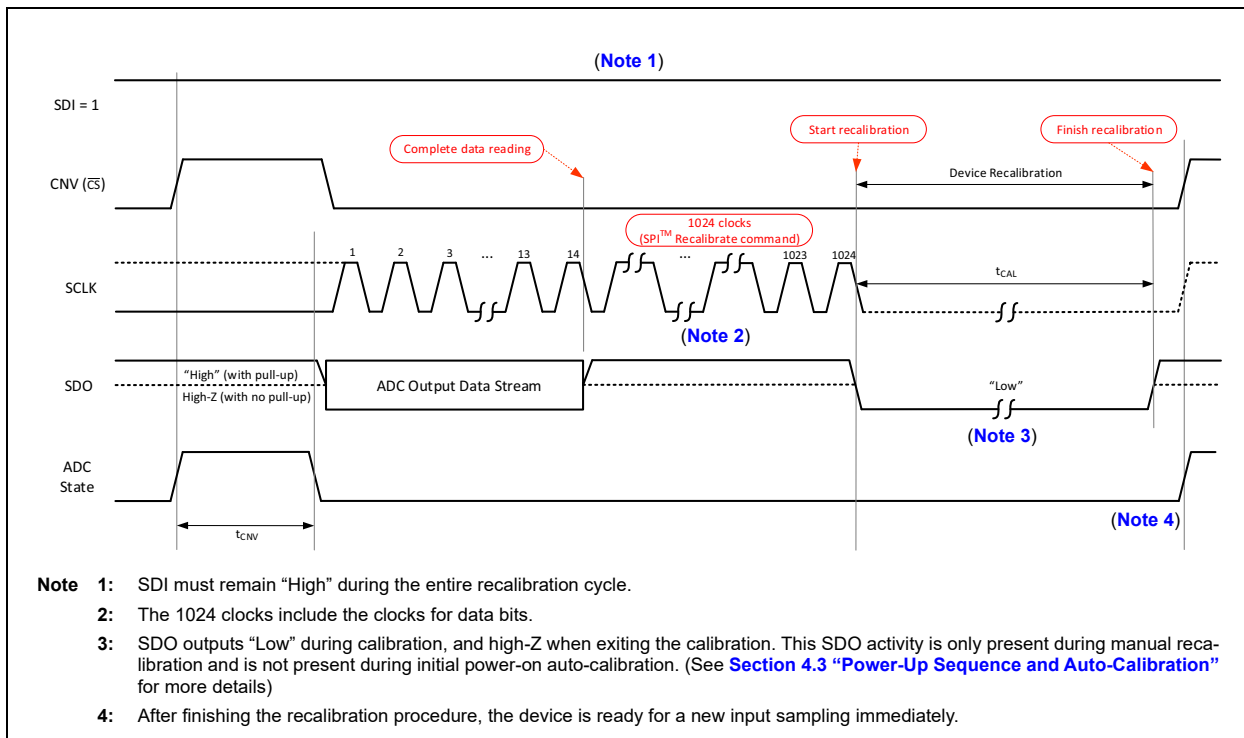

FIGURE 6-9: Recalibrate Command Timing Diagram.

Note: When the device performs a calibration, it is important to note that the analog supply voltage (AV_{DD}), the reference voltage (V_{REF}) and the digital I/O interface supply voltage (DV_{IO}) must be stabilized for a correct calibration. This is particularly relevant during the initial power-on sequence. Refer to Section 4.3 "Power-Up Sequence and Auto-Calibration" for more details.

NOTES:

MCP33151D/41D-XX

7.0 DEVELOPMENT SUPPORT

7.1 Device Evaluation Board

Microchip Technology Inc. offers a high speed/high precision SAR ADC evaluation platform which can be used to evaluate Microchip's latest high speed/high resolution SAR ADC products. The platform consists of an MCP331x1D-XX evaluation board, a data capture board (PIC32 MZ EF Curiosity Board), and a PC-based Graphical User Interface (GUI) software.

Figure 7-1 and Figure 7-2 show this evaluation tool. This evaluation platform allows users to quickly evaluate the ADC's performance for their specific application requirements.

Note: Contact Microchip Technology Inc. for the PIC32 MCU firmware and the MCP331x1D-XX Evaluation Kit.

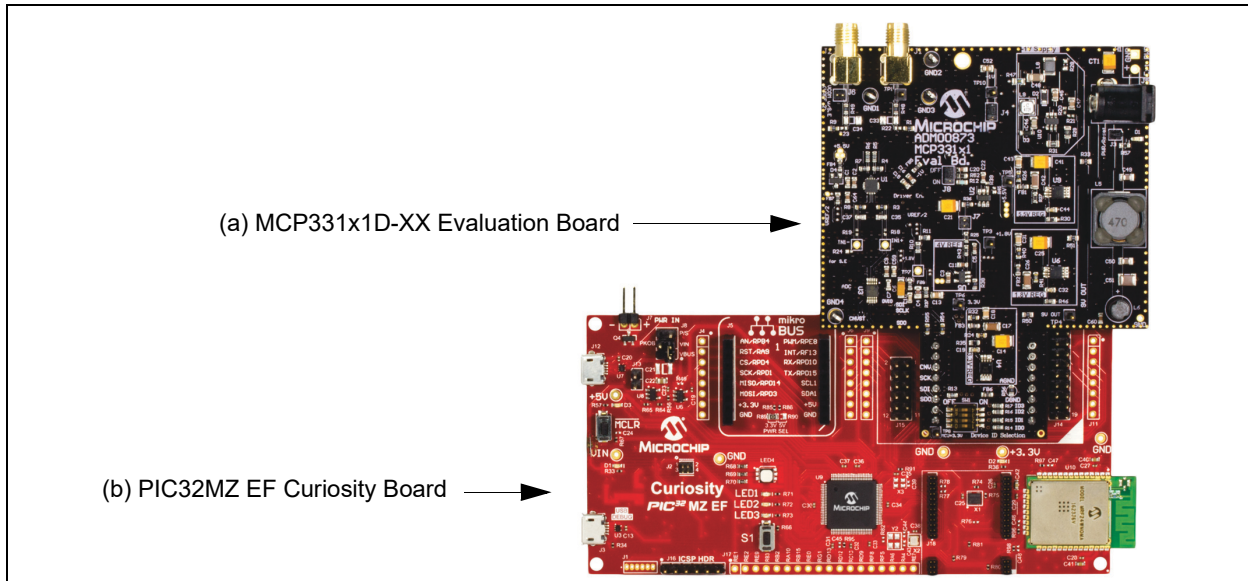

FIGURE 7-1: MCP331x1D-XX Evaluation Kit.

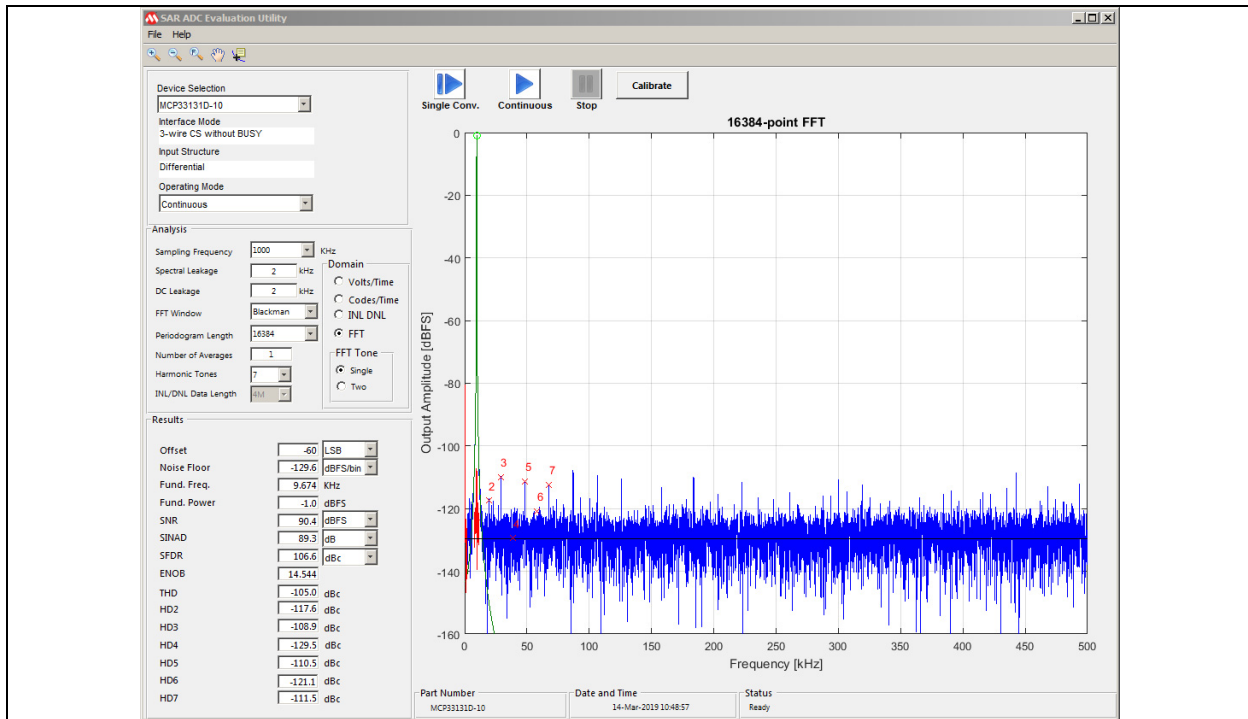

FIGURE 7-2: PC-Based Graphical User Interface Software.

7.2 PCB Layout Guidelines

Microchip provides the schematics and PCB layout of the MCP331x1D-XX Evaluation Board (P/N: ADM00873). It is strongly recommended that the user references the example circuits and PCB layouts.

A good schematic with low noise PCB layout is critical for high performing ADC application system designs. A few guidelines are listed below:

- Use low noise supplies (AV_{DD} , DV_{IO} , and V_{REF}).
- All supply voltage pins, including reference voltage, need decoupling capacitors. Decoupling capacitor requirements for each supply pin are shown in [Figure 4-1](#).
- Use NPO or COG type capacitor for the RC anti-aliasing filters in the analog input network.
- Keep the analog circuit section (analog input driver amplifiers, filters, voltage reference, ADC, etc.) with an analog ground plane, and the digital circuit section (MCU, digital I/O interface) with a digital ground plane. Keep these sections as much apart as possible. This will minimize any digital switching noise coupling into the analog section.
- Connect the analog and digital ground planes at a single point (away from the sensitive analog sections) with a 0Ω resistor or with a ferrite bead. See [Figure 7-3](#) as an example of separated ground planes.
- Keep the clock and digital output data lines short and away from the sensitive analog sections as much as possible.
- **PCB Material and Layers:** Low-loss FR-4 material is most commonly used.

The following four layers are recommended:

(a) Top Layer: Most of the noise-sensitive analog components are populated on the top layer. Use all unused surface area as ground planes: analog ground plane in analog circuit section and digital ground in digital circuit section. These ground planes need to be tied to the corresponding ground planes in the second and bottom layers using multiple vias.

(b) 2nd Layer: Use this layer as the ground plane: Analog ground plane under the analog circuit section of the top layer and digital ground plane under the digital circuit section on the top layer. Each ground plane is tied to its corresponding ground plane of top and bottom layers using multiple vias.

(c) 3rd Layer: This layer is used to distribute various power supplies of the circuits. Use separate trace paths for the power supplies of analog and digital sections. Do not use the same power supply source for both analog and digital circuits.

(d) Bottom Layer: This layer is mostly used as a solid ground plane: Analog ground plane under the analog circuit section of the top layer and digital ground plane under the digital circuit section on the top layer. Each ground plane is tied to its corresponding ground plane of all layers using multiple vias.

[Figure 7-3](#) and [Figure 7-4](#) show brief examples of the PCB layout. See more details of the schematics and PCB layout in the MCP331x1D-XX Evaluation Board User's Guide.

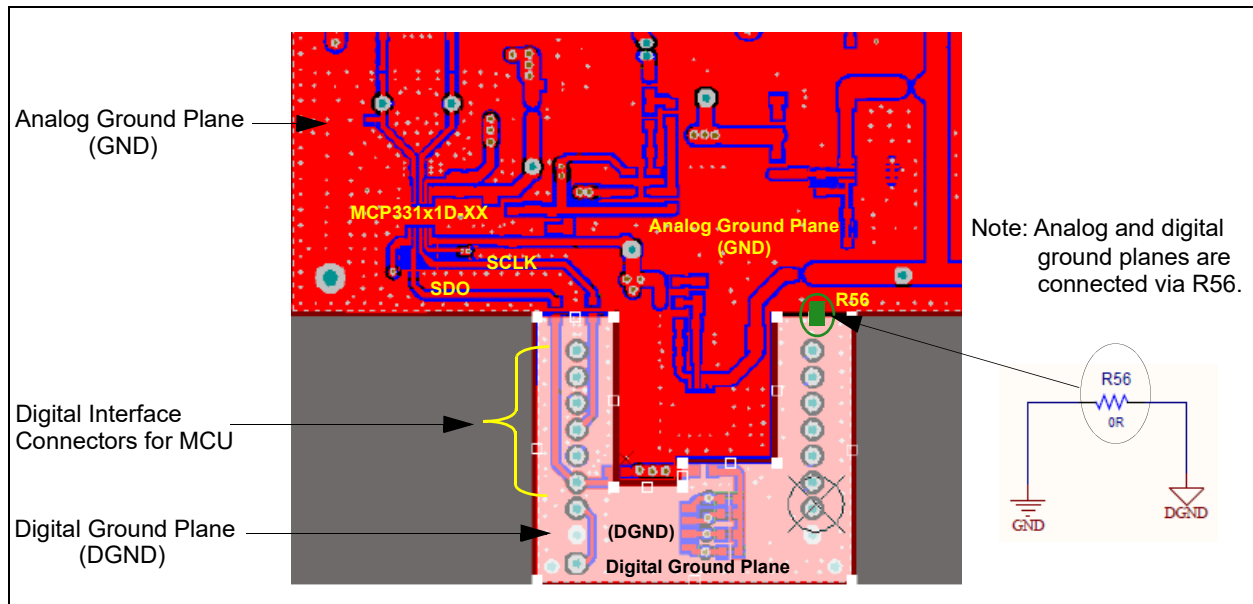
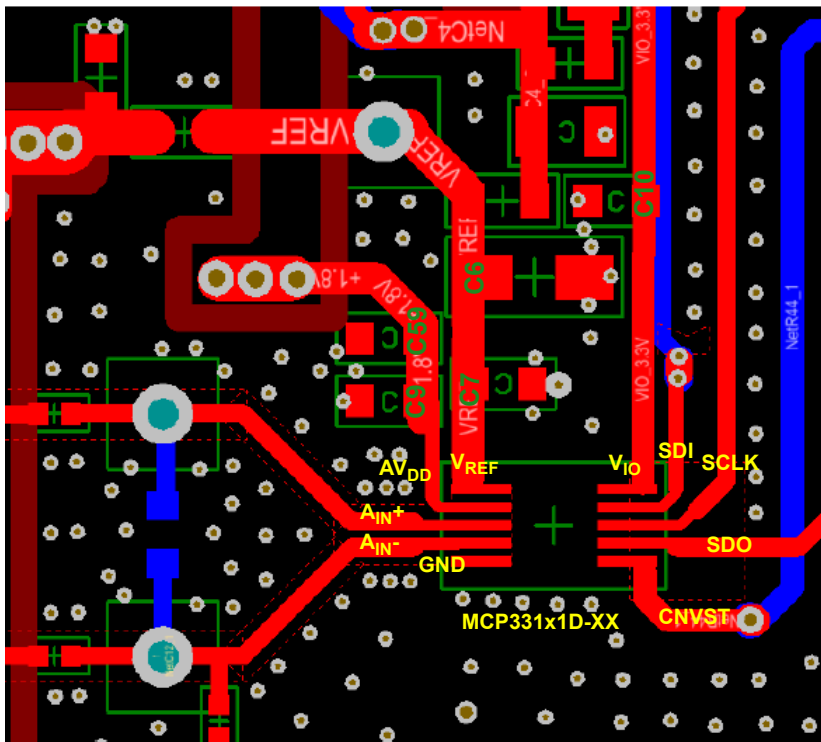
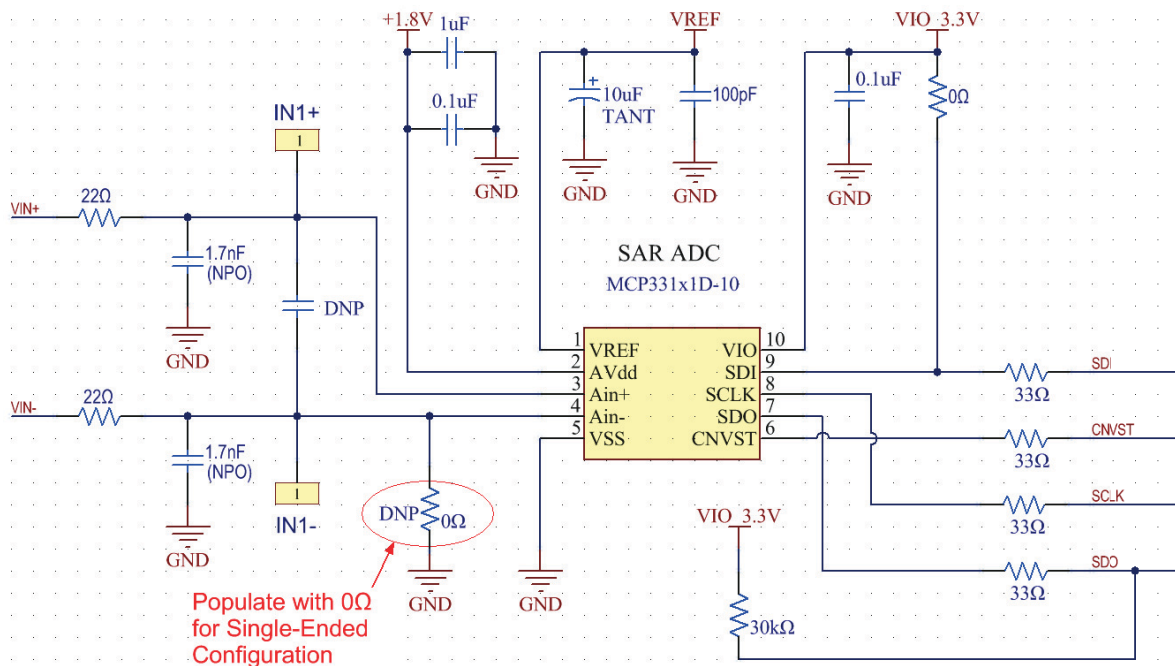

FIGURE 7-3: PCB Layout Example: Analog and Digital Ground Planes.

MCP33151D/41D-XX



(a) PCB layout example



(b) Schematic example from the MCP331x1D-XX Evaluation Board

FIGURE 7-4: PCB Layout Example: See More Details in the MCP331x1D-XX EV Kit User's Guide.

NOTES:

MCP33151D/41D-XX

8.0 TERMINOLOGY

Analog Input Bandwidth (Full-Power Bandwidth)

The analog input frequency at which the spectral power of the fundamental frequency (as determined by FFT analysis) is reduced by 3 dB.

Aperture Delay or Sampling Delay

This is the time delay between the rising edge of the CNVST input and when the input signal is held for a conversion.

Differential Nonlinearity (DNL, No Missing Codes)

An ideal ADC exhibits code transitions that are exactly 1 LSB apart. DNL is the deviation from this ideal value. No missing codes indicates that all 16384 codes for 14-bit (4096 codes for 12-bit) must be present over all the operating conditions.

Integral Nonlinearity (INL)

INL is the maximum deviation of each individual code from an ideal straight line drawn from negative full scale through positive full scale.

Signal-to-Noise Ratio (SNR)

SNR is the ratio of the power of the fundamental (P_S) to the noise floor power (P_N), below the Nyquist frequency and excluding the power at DC and the first nine harmonics.

EQUATION 8-1:

$$SNR = 10 \log \left(\frac{P_S}{P_N} \right)$$

SNR is either given in units of dBc (dB to carrier), when the absolute power of the fundamental is used as the reference, or dBFS (dB to full-scale), when the power of the fundamental is extrapolated to the converter full-scale range.

Signal-to-Noise and Distortion (SINAD)

SINAD is the ratio of the power of the fundamental (P_S) to the power of all the other spectral components including noise (P_N) and distortion (P_D) below the Nyquist frequency, but excluding DC:

EQUATION 8-2:

$$SINAD = 10 \log \left(\frac{P_S}{P_D + P_N} \right) \\ = -10 \log \left[10^{\frac{SNR}{10}} - 10^{\frac{THD}{10}} \right]$$

SINAD is either given in units of dBc (dB to carrier), when the absolute power of the fundamental is used as the reference, or dBFS (dB to full-scale), when the power of the fundamental is extrapolated to the converter full-scale range.

Effective Number of Bits (ENOB)

The effective number of bits for a sine wave input at a given input frequency can be calculated directly from its measured SINAD using the following formula:

EQUATION 8-3:

$$ENOB = \frac{SINAD - 1.76}{6.02}$$

Gain Error

Gain error is the deviation of the ADC's actual input full-scale range from its ideal value. The gain error is given as a percentage of the ideal input full-scale range. Gain error is usually expressed in LSB or as a percentage of full-scale range (%FSR).

Offset Error

The major carry transition should occur for an analog value of $\frac{1}{2}$ LSB below $A_{IN+} = A_{IN-}$. Offset error is defined as the deviation of the actual transition from that point.

Temperature Drift

The temperature drift for offset error and gain error specifies the maximum change from the initial (+25°C) value to the value at across the T_{MIN} to T_{MAX} range. The value is normalized by the reference voltage and expressed in $\mu V/^\circ C$ or $ppm/^\circ C$.

Maximum Conversion Rate

The maximum clock rate at which parametric testing is performed.

Spurious-Free Dynamic Range (SFDR)

SFDR is the ratio of the power of the fundamental to the highest other spectral component (either spur or harmonic). SFDR is typically given in units of dBc (dB to carrier) or dBFS.

Total Harmonic Distortion (THD)

THD is the ratio of the power of the fundamental (P_S) to the summed power of the first 13 harmonics (P_D).

EQUATION 8-4:

$$THD = 10\log\left(\frac{P_S}{P_D}\right)$$

THD is typically given in units of dBc (dB to carrier). THD is also shown by:

EQUATION 8-5:

$$THD = -20\log\frac{\sqrt{V_2^2 + V_3^2 + V_4^2 + \dots + V_n^2}}{V_1^2}$$

Where:

V_1 = RMS amplitude of the fundamental frequency

V_1 through V_n = Amplitudes of the second through n^{th} harmonics

Common-Mode Rejection Ratio (CMRR)

Common-mode rejection is the ability of a device to reject a signal that is common to both sides of a differential input pair. The common-mode signal can be an AC or DC signal or a combination of the two. CMRR is measured using the ratio of the differential signal gain to the common-mode signal gain and expressed in dB with [Equation 8-6](#):

EQUATION 8-6:

$$CMRR = 20\log\left(\frac{A_{DIFF}}{A_{CM}}\right)$$

Where:

A_{DIFF} = Δ Output Code/ Δ Differential Voltage

A_{DIFF} = Δ Output Code/ Δ Common-Mode Voltage

MCP33151D/41D-XX

9.0 PACKAGING INFORMATION

9.1 Package Marking Information

10-Lead MSOP (3 × 3 mm)

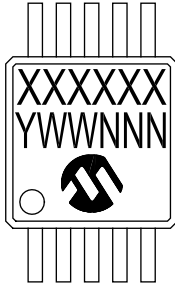

Part Number	Code
MCP33151D-10-E/MS	51D-10
MCP33151D-05-E/MS	51D-05
MCP33141D-10-E/MS	41D-10
MCP33141D-05-E/MS	41D-05

Note: Applies to 10-Lead MSOP.

Example

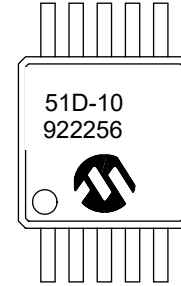

10-Lead TDFN (3 × 3 × 0.8 mm)

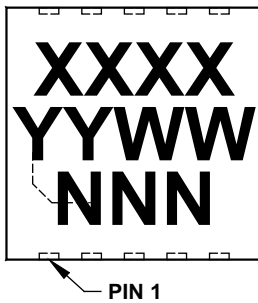

Part Number	Code
MCP33151D-10-E/MN	51D1
MCP33151D-05-E/MN	51D0
MCP33141D-10-E/MN	41D1
MCP33141D-05-E/MN	41D0

Note: Applies to 10-Lead TDFN.

Example

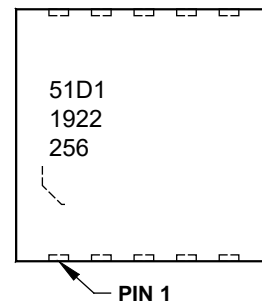

Legend:	XX...X	Customer-specific information
	Y	Year code (last digit of calendar year)
	YY	Year code (last 2 digits of calendar year)
	WW	Week code (week of January 1 is week '01')
	NNN	Alphanumeric traceability code
	(e3)	Pb-free JEDEC® designator for Matte Tin (Sn)
	*	This package is Pb-free. The Pb-free JEDEC designator (e3) can be found on the outer packaging for this package.

Note: In the event the full Microchip part number cannot be marked on one line, it will be carried over to the next line, thus limiting the number of available characters for customer-specific information.

MCP33151D/41D-XX

10-Lead Plastic Micro Small Outline Package (MS) [MSOP]

Note: For the most current package drawings, please see the Microchip Packaging Specification located at <http://www.microchip.com/packaging>

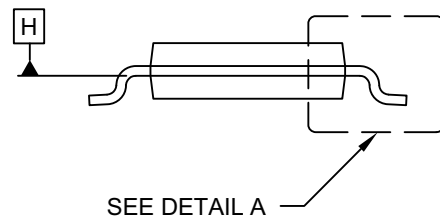
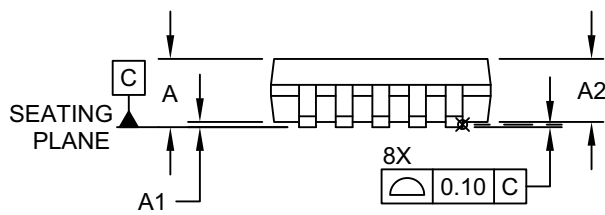
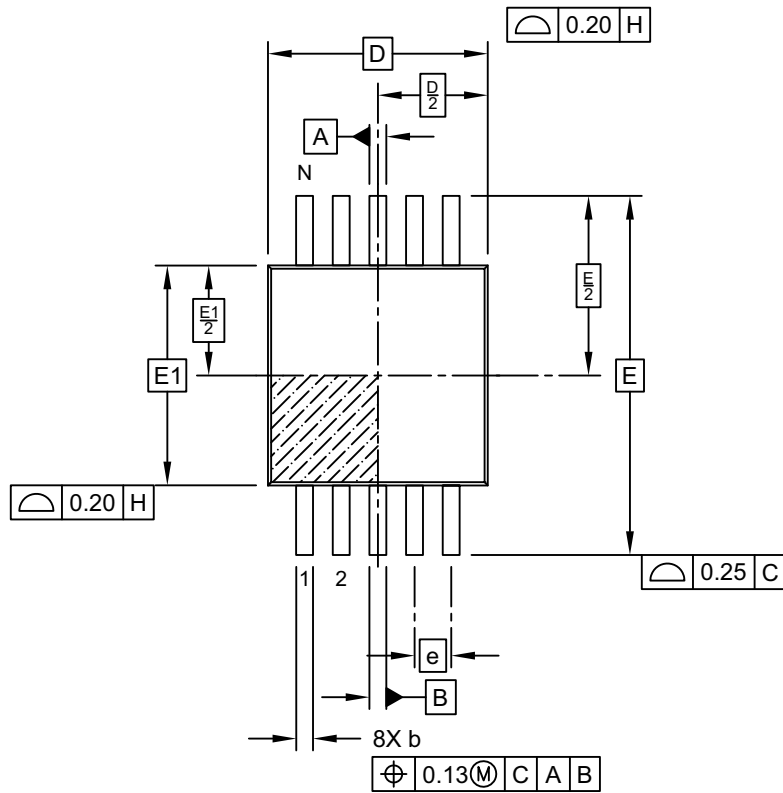

Microchip Technology Drawing C04-021D Sheet 1 of 2

MCP33151D/41D-XX

10-Lead Plastic Micro Small Outline Package (MS) [MSOP]

Note: For the most current package drawings, please see the Microchip Packaging Specification located at <http://www.microchip.com/packageing>

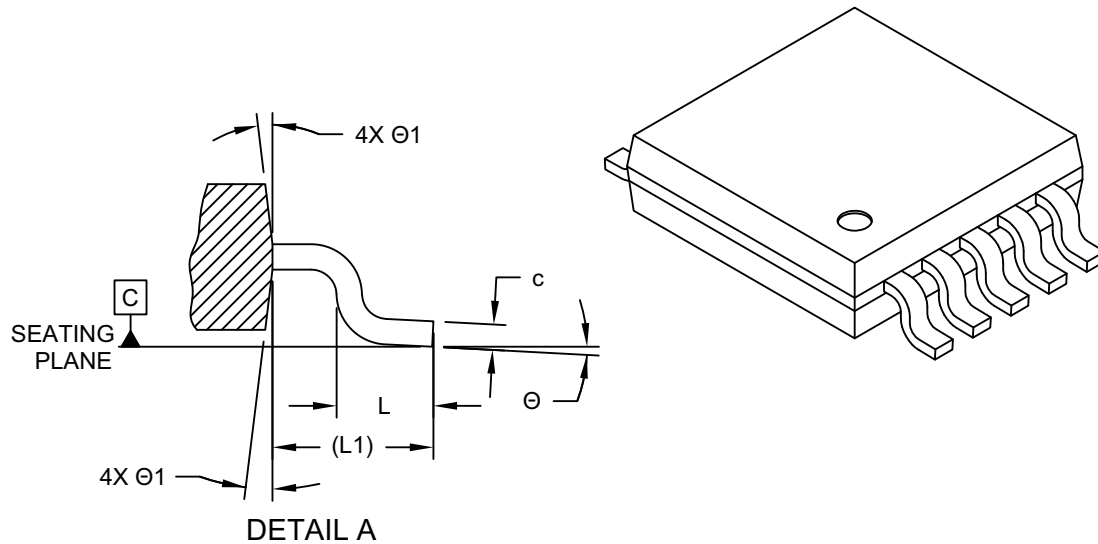

Dimension Limits	Units	MILLIMETERS		
		MIN	NOM	MAX
Number of Pins	N	10		
Pitch	e	0.50 BSC		
Overall Height	A	-	-	1.10
Molded Package Thickness	A2	0.75	0.85	0.95
Standoff	A1	0.00	-	0.15
Overall Width	E	4.90 BSC		
Molded Package Width	E1	3.00 BSC		
Overall Length	D	3.00 BSC		
Foot Length	L	0.40	0.60	0.80
Footprint	L1	0.95 REF		
Mold Draft Angle	Ø	0°	-	8°
Foot Angle	Ø1	5°	-	15°
Lead Thickness	c	0.08	-	0.23
Lead Width	b	0.15	-	0.33

Notes:

- Pin 1 visual index feature may vary, but must be located within the hatched area.
- Dimensions D and E1 do not include mold flash or protrusions. Mold flash or protrusions shall not exceed 0.15mm per side.
- Dimensioning and tolerancing per ASME Y14.5M.
 BSC: Basic Dimension. Theoretically exact value shown without tolerances.
 REF: Reference Dimension, usually without tolerance, for information purposes only.

Microchip Technology Drawing C04-021D Sheet 2 of 2

10-Lead Plastic Micro Small Outline Package (MS) [MSOP]

Note: For the most current package drawings, please see the Microchip Packaging Specification located at <http://www.microchip.com/packaging>

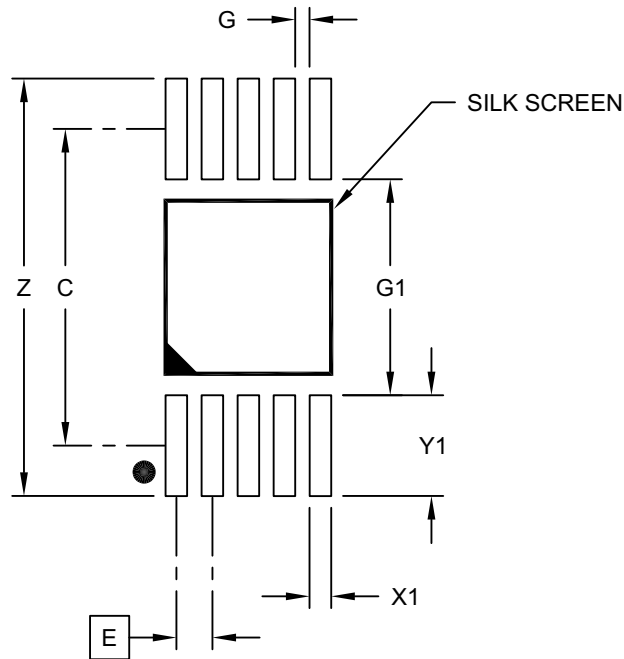

RECOMMENDED LAND PATTERN

Dimension Limits	Units	MILLIMETERS		
		MIN	NOM	MAX
Contact Pitch	E	0.50 BSC		
Contact Pad Spacing	C		4.40	
Overall Width	Z			5.80
Contact Pad Width (X10)	X1			0.30
Contact Pad Length (X10)	Y1			1.40
Distance Between Pads (X5)	G1	3.00		
Distance Between Pads (X8)	G	0.20		

Notes:

1. Dimensioning and tolerancing per ASME Y14.5M

BSC: Basic Dimension. Theoretically exact value shown without tolerances.

Microchip Technology Drawing No. C04-2021B

MCP33151D/41D-XX

10-Lead Thin Plastic Dual Flat, No Lead Package (MN) - 3x3x0.8mm Body [TDFN]

Note: For the most current package drawings, please see the Microchip Packaging Specification located at <http://www.microchip.com/packaging>

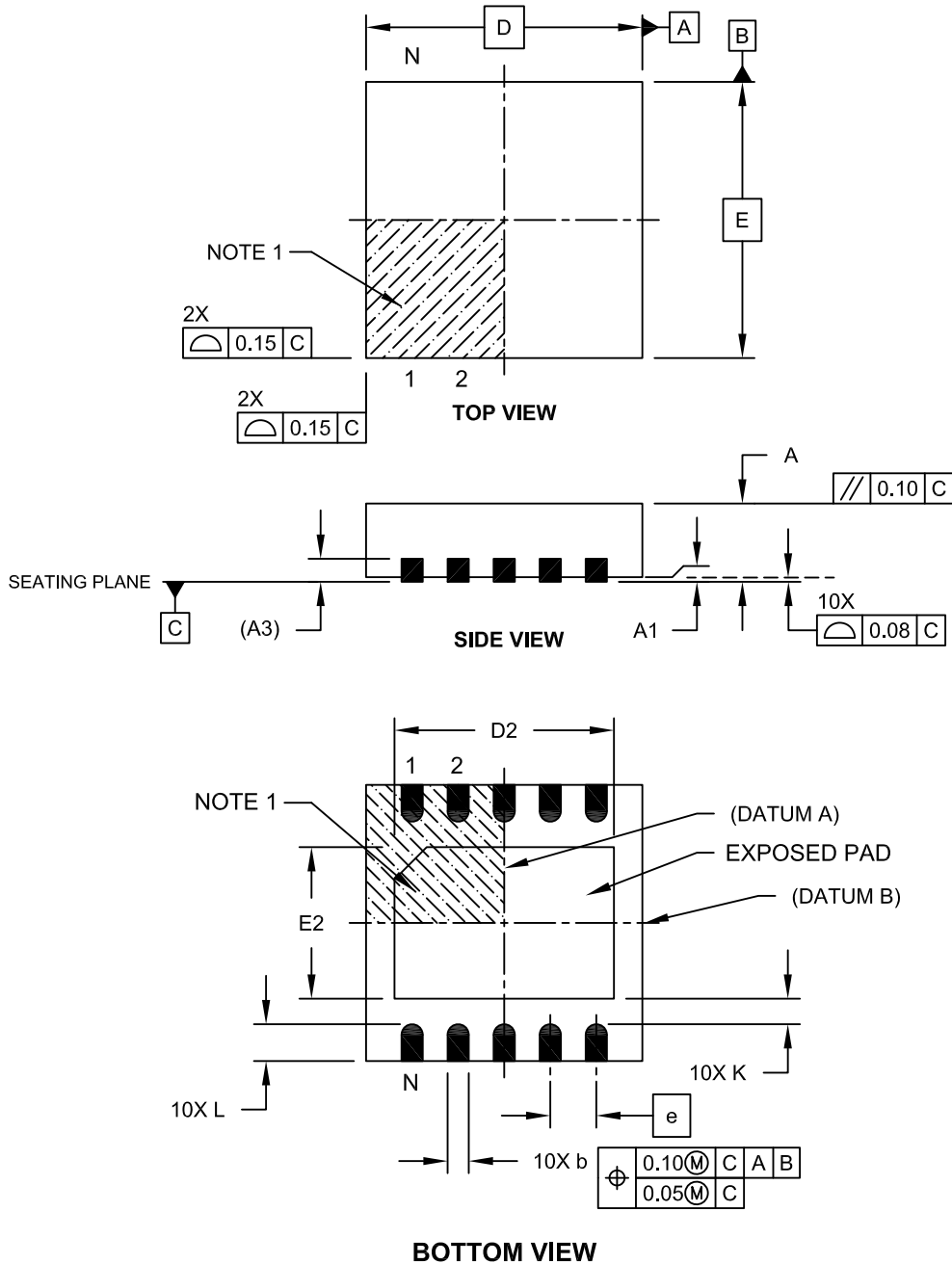

Microchip Technology Drawing C04-185A Sheet 1 of 2

MCP33151D/41D-XX

10-Lead Thin Plastic Dual Flat, No Lead Package (MN) - 3x3x0.8mm Body [TDFN]

Note: For the most current package drawings, please see the Microchip Packaging Specification located at <http://www.microchip.com/packaging>

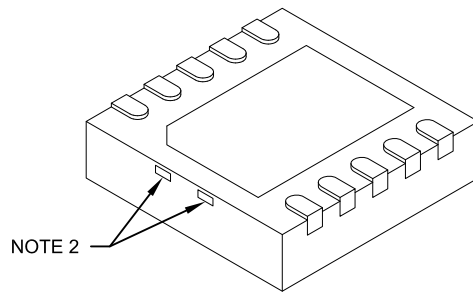

Dimension Limits	Units	MILLIMETERS		
		MIN	NOM	MAX
Number of Pins	N	10		
Pitch	e	0.50 BSC		
Overall Height	A	0.70	0.75	0.80
Standoff	A1	0.00	0.02	0.05
Contact Thickness	A3	0.20 REF		
Overall Length	D	3.00 BSC		
Exposed Pad Length	D2	2.20	2.30	2.35
Overall Width	E	3.00 BSC		
Exposed Pad Width	E2	1.55	1.65	1.70
Contact Width	b	0.18	0.25	0.30
Contact Length	L	0.30	0.40	0.50
Contact-to-Exposed Pad	K	0.20	-	-

Notes:

1. Pin 1 visual index feature may vary, but must be located within the hatched area.
2. Package may have one or more exposed tie bars at ends.
3. Package is saw singulated
4. Dimensioning and tolerancing per ASME Y14.5M
BSC: Basic Dimension. Theoretically exact value shown without tolerances.
REF: Reference Dimension, usually without tolerance, for information purposes only.

Microchip Technology Drawing No. C04-0185A Sheet 2 of 2

MCP33151D/41D-XX

APPENDIX A: REVISION HISTORY

Revision B (December 2021)

- Updated [Section 5.2.3.2 “Pseudo-Differential Unipolar Configuration”](#)
- Updated [Section 5.6 “Digital Output Codes”](#)
- Added [Section 5.6.2 “Digital Output Code for Single-Ended Input Configuration \(See Figure 5-7\)”](#)
- Updated [Section 6.1 “Serial Interface Options and Serial Communications”](#)

Revision A (June 2019)

- Initial release of this document

NOTES:

MCP33151D/41D-XX

PRODUCT IDENTIFICATION SYSTEM

To order or obtain information, e.g., on pricing or delivery, refer to the factory or the listed sales office.

<u>PART NO.</u>	<u>X</u>	<u>XX</u>	-	<u>X</u> ⁽¹⁾	-	<u>X</u>	<u>XX</u>
Device	Input Type	Sample Rate		Tape and Reel Option		Temperature Range	Package
<p>Device: MCP33151D-10 = 1 Msps, 14-Bit Differential Input SAR ADC MCP33141D-10 = 1 Msps, 12-Bit Differential Input SAR ADC MCP33151D-05 = 500 kSPS, 14-Bit Differential Input SAR ADC MCP33141D-05 = 500 kSPS, 12-Bit Differential Input SAR ADC</p> <p>Input Type: D = Differential Input</p> <p>Sample Rate: 10 = 1 Msps 05 = 500 kSPS</p> <p>Tape and Reel Option: Blank = Standard packaging (tube or tray) T = Tape and Reel (Note 1)</p> <p>Temperature Range: E = -40°C to +125°C (Extended)</p> <p>Package: MS = Plastic Micro Small Outline Package (MSOP), 10-Lead MN = Thin Plastic Dual Flat No Lead Package (TDFN), 10-Lead (Note 2)</p>							
<p>Examples:</p> <p>a) MCP33151D-10-E/MS: 14-bit, 1 Msps, 10-LD MSOP package</p> <p>b) MCP33151D-10T-E/MS: 14-bit, 1 Msps, Tape and Reel, 10-LD MSOP package</p> <p>c) MCP33151D-10-E/MN: 14-bit, 1 Msps, 10-LD TDFN package</p> <p>d) MCP33151D-10T-E/MN: 14-bit, 1 Msps, Tape and Reel, 10-LD TDFN package</p> <p>e) MCP33141D-10-E/MS: 12-bit, 1 Msps, 10-LD MSOP package</p> <p>f) MCP33141D-10T-E/MS: 12-bit, 1 Msps, Tape and Reel, 10-LD MSOP package</p> <p>g) MCP33141D-10-E/MN: 12-bit, 1 Msps, 10-LD TDFN package</p> <p>h) MCP33141D-10T-E/MN: 12-bit, 1 Msps, Tape and Reel, 10-LD TDFN package</p> <p>i) MCP33151D-05-E/MS: 14-bit, 500 kSPS, 10-LD MSOP package</p> <p>j) MCP33151D-05T-E/MS: 14-bit, 500 kSPS, Tape and Reel, 10-LD MSOP package</p> <p>k) MCP33151D-05T-E/MN: 14-bit, 500 kSPS, Tape and Reel, 10-LD TDFN package</p> <p>l) MCP33141D-05-E/MS: 12-bit, 500 kSPS, 10-LD MSOP package</p> <p>m) MCP33141D-05T-E/MN: 12-bit, 500 kSPS, Tape and Reel, 10-LD TDFN package</p> <p>Note 1: Tape and Reel identifier only appears in the catalog part number description. This identifier is used for ordering purposes and is not printed on the device package. Check with your Microchip Sales Office for package availability with the Tape and Reel option.</p> <p>Note 2: Contact Microchip Technology Inc. for availability.</p>							

MCP33151D/41D-XX

NOTES:

Note the following details of the code protection feature on Microchip products:

- Microchip products meet the specifications contained in their particular Microchip Data Sheet.
- Microchip believes that its family of products is secure when used in the intended manner, within operating specifications, and under normal conditions.
- Microchip values and aggressively protects its intellectual property rights. Attempts to breach the code protection features of Microchip product is strictly prohibited and may violate the Digital Millennium Copyright Act.
- Neither Microchip nor any other semiconductor manufacturer can guarantee the security of its code. Code protection does not mean that we are guaranteeing the product is “unbreakable”. Code protection is constantly evolving. Microchip is committed to continuously improving the code protection features of our products.

This publication and the information herein may be used only with Microchip products, including to design, test, and integrate Microchip products with your application. Use of this information in any other manner violates these terms. Information regarding device applications is provided only for your convenience and may be superseded by updates. It is your responsibility to ensure that your application meets with your specifications. Contact your local Microchip sales office for additional support or, obtain additional support at <https://www.microchip.com/en-us/support/design-help/client-support-services>.

THIS INFORMATION IS PROVIDED BY MICROCHIP "AS IS". MICROCHIP MAKES NO REPRESENTATIONS OR WARRANTIES OF ANY KIND WHETHER EXPRESS OR IMPLIED, WRITTEN OR ORAL, STATUTORY OR OTHERWISE, RELATED TO THE INFORMATION INCLUDING BUT NOT LIMITED TO ANY IMPLIED WARRANTIES OF NON-INFRINGEMENT, MERCHANTABILITY, AND FITNESS FOR A PARTICULAR PURPOSE, OR WARRANTIES RELATED TO ITS CONDITION, QUALITY, OR PERFORMANCE.

IN NO EVENT WILL MICROCHIP BE LIABLE FOR ANY INDIRECT, SPECIAL, PUNITIVE, INCIDENTAL, OR CONSEQUENTIAL LOSS, DAMAGE, COST, OR EXPENSE OF ANY KIND WHATSOEVER RELATED TO THE INFORMATION OR ITS USE, HOWEVER CAUSED, EVEN IF MICROCHIP HAS BEEN ADVISED OF THE POSSIBILITY OR THE DAMAGES ARE FORESEEABLE. TO THE FULLEST EXTENT ALLOWED BY LAW, MICROCHIP'S TOTAL LIABILITY ON ALL CLAIMS IN ANY WAY RELATED TO THE INFORMATION OR ITS USE WILL NOT EXCEED THE AMOUNT OF FEES, IF ANY, THAT YOU HAVE PAID DIRECTLY TO MICROCHIP FOR THE INFORMATION.

Use of Microchip devices in life support and/or safety applications is entirely at the buyer's risk, and the buyer agrees to defend, indemnify and hold harmless Microchip from any and all damages, claims, suits, or expenses resulting from such use. No licenses are conveyed, implicitly or otherwise, under any Microchip intellectual property rights unless otherwise stated.

For information regarding Microchip's Quality Management Systems, please visit www.microchip.com/quality.

Trademarks

The Microchip name and logo, the Microchip logo, Adaptec, AnyRate, AVR, AVR logo, AVR Freaks, BesTime, BitCloud, CryptoMemory, CryptoRF, dsPIC, flexPWR, HELDO, IGLOO, JukeBlox, KeeLoq, Kleer, LANCheck, LinkMD, maXStylus, maXTouch, MediaLB, megaAVR, Microsemi, Microsemi logo, MOST, MOST logo, MPLAB, OptoLyzer, PIC, picoPower, PICSTART, PIC32 logo, PolarFire, Prochip Designer, QTouch, SAM-BA, SenGenuity, SpyNIC, SST, SST Logo, SuperFlash, Symmetricom, SyncServer, Tachyon, TimeSource, tinyAVR, UNI/O, Vectron, and XMEGA are registered trademarks of Microchip Technology Incorporated in the U.S.A. and other countries.

AgileSwitch, APT, ClockWorks, The Embedded Control Solutions Company, EtherSynch, Flashtec, Hyper Speed Control, HyperLight Load, IntelliMOS, Libero, motorBench, mTouch, Powermite 3, Precision Edge, ProASIC, ProASIC Plus, ProASIC Plus logo, QuietWire, SmartFusion, SyncWorld, Temux, TimeCesium, TimeHub, TimePictra, TimeProvider, TrueTime, WinPath, and ZL are registered trademarks of Microchip Technology Incorporated in the U.S.A.

Adjacent Key Suppression, AKS, Analog-for-the-Digital Age, Any Capacitor, AnyIn, AnyOut, Augmented Switching, BlueSky, BodyCom, CodeGuard, CryptoAuthentication, CryptoAutomotive, CryptoCompanion, CryptoController, dsPICDEM, dsPICDEM.net, Dynamic Average Matching, DAM, ECAN, Espresso T1S, EtherGREEN, GridTime, IdealBridge, In-Circuit Serial Programming, ICSP, INICnet, Intelligent Paralleling, Inter-Chip Connectivity, JitterBlocker, Knob-on-Display, maxCrypto, maxView, memBrain, Mindi, MiWi, MPASM, MPF, MPLAB Certified logo, MPLIB, MPLINK, MultiTRAK, NetDetach, NVM Express, NVMe, Omniscient Code Generation, PICDEM, PICDEM.net, PICKit, PICtail, PowerSmart, PureSilicon, QMatrix, REAL ICE, Ripple Blocker, RTAX, RTG4, SAM-ICE, Serial Quad I/O, simpleMAP, SimpliPHY, SmartBuffer, SmartHLS, SMART-I.S., storClad, SQL, SuperSwitcher, SuperSwitcher II, Switchtec, SynchroPHY, Total Endurance, TSHARC, USBCheck, VariSense, VectorBlox, VeriPHY, ViewSpan, WiperLock, XpressConnect, and ZENA are trademarks of Microchip Technology Incorporated in the U.S.A. and other countries.

SQTP is a service mark of Microchip Technology Incorporated in the U.S.A.

The Adaptec logo, Frequency on Demand, Silicon Storage Technology, Symmcom, and Trusted Time are registered trademarks of Microchip Technology Inc. in other countries.

GestIC is a registered trademark of Microchip Technology Germany II GmbH & Co. KG, a subsidiary of Microchip Technology Inc., in other countries.

All other trademarks mentioned herein are property of their respective companies.

© 2019-2021, Microchip Technology Incorporated and its subsidiaries.

All Rights Reserved.

ISBN: 978-1-5224-9359-4



MICROCHIP

Worldwide Sales and Service

AMERICAS

Corporate Office
2355 West Chandler Blvd.
Chandler, AZ 85224-6199
Tel: 480-792-7200
Fax: 480-792-7277
Technical Support:
<http://www.microchip.com/support>
Web Address:
www.microchip.com

Atlanta

Duluth, GA
Tel: 678-957-9614
Fax: 678-957-1455

Austin, TX

Tel: 512-257-3370

Boston

Westborough, MA
Tel: 774-760-0087
Fax: 774-760-0088

Chicago

Itasca, IL
Tel: 630-285-0071
Fax: 630-285-0075

Dallas

Addison, TX
Tel: 972-818-7423
Fax: 972-818-2924

Detroit

Novi, MI
Tel: 248-848-4000

Houston, TX

Tel: 281-894-5983

Indianapolis

Noblesville, IN
Tel: 317-773-8323
Fax: 317-773-5453
Tel: 317-536-2380

Los Angeles

Mission Viejo, CA
Tel: 949-462-9523
Fax: 949-462-9608
Tel: 951-273-7800

Raleigh, NC

Tel: 919-844-7510

New York, NY

Tel: 631-435-6000

San Jose, CA

Tel: 408-735-9110
Tel: 408-436-4270

Canada - Toronto

Tel: 905-695-1980
Fax: 905-695-2078

ASIA/PACIFIC

Australia - Sydney
Tel: 61-2-9868-6733

China - Beijing
Tel: 86-10-8569-7000

China - Chengdu
Tel: 86-28-8665-5511

China - Chongqing
Tel: 86-23-8980-9588

China - Dongguan
Tel: 86-769-8702-9880

China - Guangzhou
Tel: 86-20-8755-8029

China - Hangzhou
Tel: 86-571-8792-8115

China - Hong Kong SAR
Tel: 852-2943-5100

China - Nanjing
Tel: 86-25-8473-2460

China - Qingdao
Tel: 86-532-8502-7355

China - Shanghai
Tel: 86-21-3326-8000

China - Shenyang
Tel: 86-24-2334-2829

China - Shenzhen
Tel: 86-755-8864-2200

China - Suzhou
Tel: 86-186-6233-1526

China - Wuhan
Tel: 86-27-5980-5300

China - Xian
Tel: 86-29-8833-7252

China - Xiamen
Tel: 86-592-2388138

China - Zhuhai
Tel: 86-756-3210040

ASIA/PACIFIC

India - Bangalore
Tel: 91-80-3090-4444

India - New Delhi
Tel: 91-11-4160-8631

India - Pune
Tel: 91-20-4121-0141

Japan - Osaka
Tel: 81-6-6152-7160

Japan - Tokyo
Tel: 81-3-6880-3770

Korea - Daegu
Tel: 82-53-744-4301

Korea - Seoul
Tel: 82-2-554-7200

Malaysia - Kuala Lumpur
Tel: 60-3-7651-7906

Malaysia - Penang
Tel: 60-4-227-8870

Philippines - Manila
Tel: 63-2-634-9065

Singapore
Tel: 65-6334-8870

Taiwan - Hsin Chu
Tel: 886-3-577-8366

Taiwan - Kaohsiung
Tel: 886-7-213-7830

Taiwan - Taipei
Tel: 886-2-2508-8600

Thailand - Bangkok
Tel: 66-2-694-1351

Vietnam - Ho Chi Minh
Tel: 84-28-5448-2100

EUROPE

Austria - Wels
Tel: 43-7242-2244-39
Fax: 43-7242-2244-393

Denmark - Copenhagen
Tel: 45-4485-5910
Fax: 45-4485-2829

Finland - Espoo
Tel: 358-9-4520-820

France - Paris
Tel: 33-1-69-53-63-20
Fax: 33-1-69-30-90-79

Germany - Garching
Tel: 49-8931-9700

Germany - Haan
Tel: 49-2129-3766400

Germany - Heilbronn
Tel: 49-7131-72400

Germany - Karlsruhe
Tel: 49-721-625370

Germany - Munich
Tel: 49-89-627-144-0
Fax: 49-89-627-144-44

Germany - Rosenheim
Tel: 49-8031-354-560

Israel - Ra'anana
Tel: 972-9-744-7705

Italy - Milan
Tel: 39-0331-742611
Fax: 39-0331-466781

Italy - Padova
Tel: 39-049-7625286

Netherlands - Drunen
Tel: 31-416-690399
Fax: 31-416-690340

Norway - Trondheim
Tel: 47-7288-4388

Poland - Warsaw
Tel: 48-22-3325737

Romania - Bucharest
Tel: 40-21-407-87-50

Spain - Madrid
Tel: 34-91-708-08-90
Fax: 34-91-708-08-91

Sweden - Gothenberg
Tel: 46-31-704-60-40

Sweden - Stockholm
Tel: 46-8-5090-4654

UK - Wokingham
Tel: 44-118-921-5800
Fax: 44-118-921-5820

Mouser Electronics

Authorized Distributor

Click to View Pricing, Inventory, Delivery & Lifecycle Information:

Microchip:

[MCP33141D-05T-E/MS](#) [MCP33141D-10T-E/MN](#) [MCP33141D-10T-E/MS](#) [MCP33151D-10T-E/MS](#) [MCP33141D-05T-E/MN](#) [MCP33151D-05T-E/MN](#) [MCP33151D-05T-E/MS](#) [MCP33151D-10T-E/MN](#) [MCP33141D-05-E/MN](#) [MCP33141D-10-E/MN](#) [MCP33151D-10-E/MS](#) [MCP33151D-10-E/MN](#) [MCP33141D-10-E/MS](#) [MCP33151D-05-E/MN](#) [MCP33141D-05-E/MS](#) [MCP33151D-05-E/MS](#)