



MP2639B

1S Cell Li-ion or Li-polymer Switching Charger
Compatible with Wide Input Range and
Integrated Programmable OTG

DESCRIPTION

The MP2639B is a highly integrated, flexible switch-mode battery charging management device for a single-cell Li-ion and Li-Polymer battery used in a wide range of portable applications.

The MP2639B works in three modes: charge mode, discharge mode, and sleep mode. (See Table 1)

When the input power supply is available, the MP2639B operates as a switching charger to charge a 1S battery from a wide input power range of 5V to 16V, which can cover a USB PD voltage level. The MP2639B automatically detects the battery voltage and charges the battery in three phases: pre-charge, constant charge, and constant voltage charge. Other features include charge termination and auto-recharge.

When the input is absent, the MP2639B can provide a wide boost voltage to IN by adjusting the feedback voltage at FB. When working with the PD controller, the MP2639B can support a USB PD standard output voltage level.

To guarantee safe operation, the MP2639B limits the die temperature to a preset value of 120°C. Other safety features include input over-voltage protection, battery over-voltage protection, thermal shutdown, battery temperature monitoring, and a programmable timer to prevent prolonged charging of a dead battery.

FEATURES

- 4.5V to 16V Input Voltage Range
- Integrated Both Input-Current-Based and Input-Voltage-Based Power Management Functions
- Up to 5A Programmable Charge Current
- 4.35V Charge Voltage with 0.5% Accuracy
- Up to 3A Programmable Boost Output Current
- Up to 16V Programmable Boost Output Voltage
- Negative Temperature Coefficient Pin for Temperature Monitoring
- Programmable Timer Back-Up Protection
- Discharge Mode Load Trace Compensation
- Thermal Regulation and Thermal Shutdown
- Internal Battery Reverse Leakage Blocking
- Integrated Short-Circuit Protection for Boost Mode
- 4 LEDs Battery Level and Status Indication
- 4mmx4mm QFN-26 Package

APPLICATIONS

- Power Station Applications
- USB PD Power Banks
- Mobile Internet Devices

All MPS parts are lead-free, halogen free, and adhere to the RoHS directive. For MPS green status, please visit MPS website under Quality Assurance.

"MPS" and "The Future of Analog IC Technology" are Registered Trademarks of Monolithic Power Systems, Inc.

ADAM (Analog Digital Adaptive Modulation), AAM (...) are Trademarks of Monolithic Power Systems, Inc.

TYPICAL APPLICATION

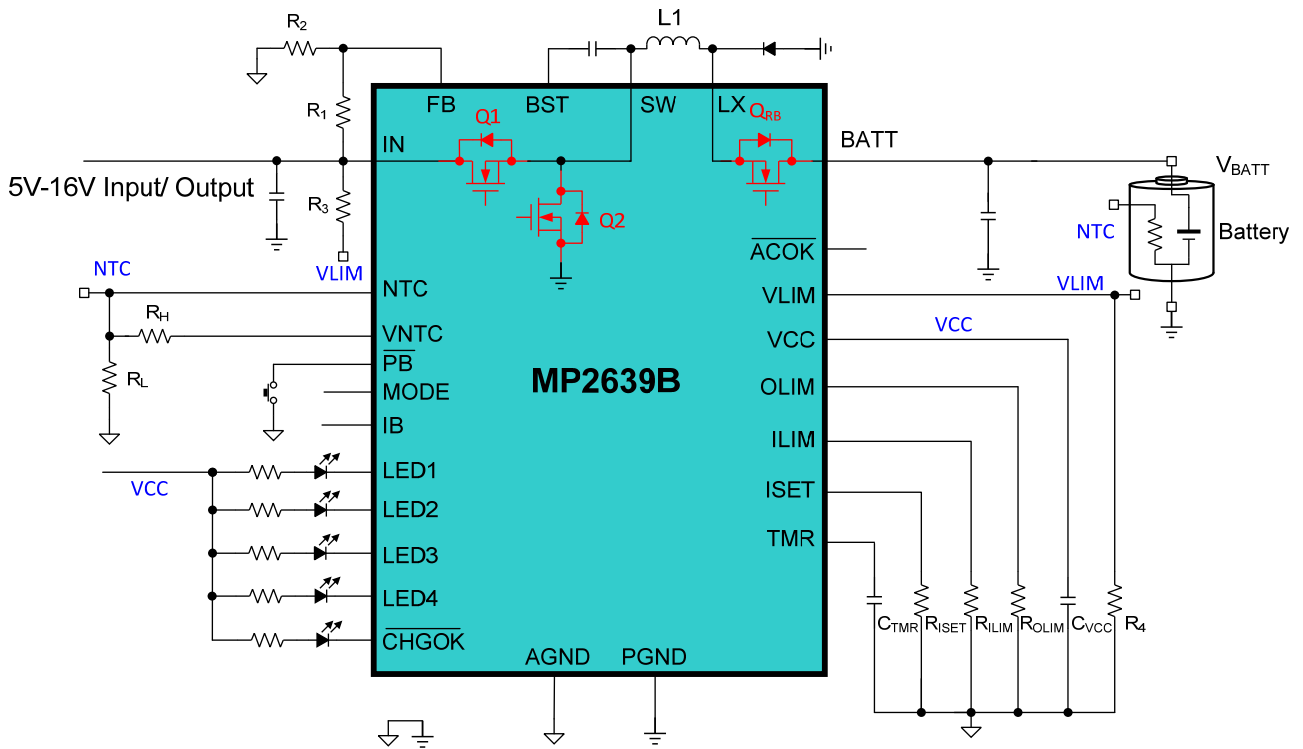

Table 1: Operation Mode Table

| MODE Pin | Operation Mode | Active SW | Topology |
|----------|-------------------------------|-----------|-----------|
| High | Discharge Mode ⁽¹⁾ | Q2 | Step-up |
| Low | Charge Mode | Q1 | Step-down |

Note: (1) MODE=high and pushing PB to start the discharge.

ORDERING INFORMATION

| Part Number* | Package | Top Marking |
|---------------|------------------|-------------|
| MP2639BGR | QFN-26 (4mmx4mm) | See Below |
| EV2639B-R-00A | Evaluation Kit | |

* For Tape & Reel, add suffix -Z (e.g. MP2639BGR-Z).

TOP MARKING

MPSYWW

M2639B

LLLLLL

MPS: MPS prefix
 Y: Year code
 WW: Week code
 M2639B: Part number
 LLLLLL: Lot number

PACKAGE REFERENCE

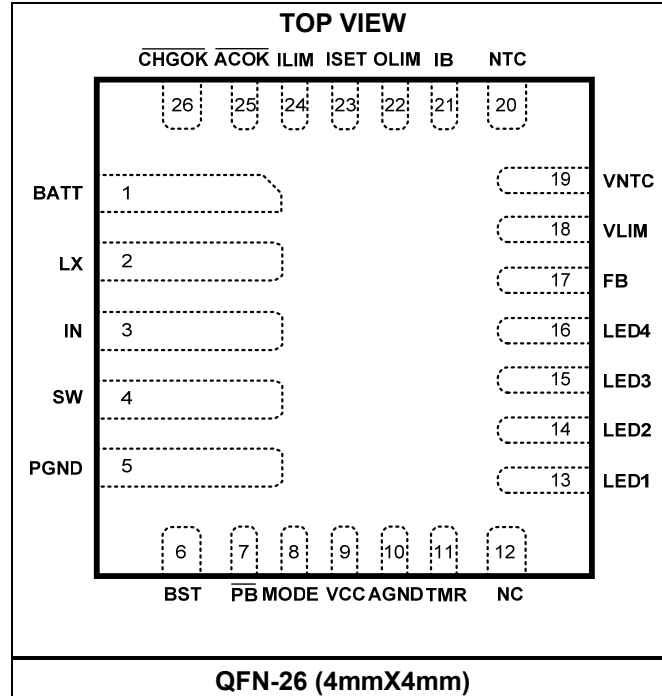

PIN FUNCTIONS

| Package Pin # | Name | Description |
|---------------|-------|---|
| 1 | BATT | Battery terminal. |
| 2 | LX | Connection node between inductor and the internal block switch. |
| 3 | IN | Input power pin. |
| 4 | SW | Switching node. |
| 5 | PGND | Power ground. Connect the exposed pad and PGND to the same ground plane. |
| 6 | BST | Bootstrap. Connect a BST capacitor between BST and SW node. |
| 7 | PB | Push button input. Connect a push button from PB to AGND, internally pulled up by a resistor. When PB is pushed for less than 2.5s, the discharge function is enabled and latched when MODE is high. If discharging is enabled, pushing the button for longer than 2.5s can disable the discharge. Otherwise, discharging remains and LED1-4 are enabled for 5s. |
| 8 | MODE | Charge or discharge mode selection. Pull logic LOW to make the MP2639B to work in charge mode; pull logic HIGH to make it work in discharge mode. |
| 9 | VCC | Internal circuit power supply. Bypass to AGND with a 1 μ F ceramic capacitor. VCC CANNOT float or carry a load higher than 20mA. |
| 10 | AGND | Analog ground. |
| 11 | TMR | Oscillator period timer. Connect a timing capacitor between TMR and AGND to set the oscillator period. Short TMR to AGND to disable the timer function. |
| 12 | NC | Connecting NC to AGND is recommended. |
| 13 | LED1 | Fuel gauge. LED1 works with LED2, LED3, LED4 to achieve the voltage-based fuel gauge indication. |
| 14 | LED2 | Fuel gauge. LED2 works with LED1, LED3, LED4 to achieve the voltage-based fuel gauge indication. |
| 15 | LED3 | Fuel gauge. LED3 works with LED1, LED2, LED4 to achieve the voltage-based fuel gauge indication. |
| 16 | LED4 | Fuel gauge. LED4 works with LED1, LED2, LED3 to achieve the voltage-based fuel gauge indication. |
| 17 | FB | Voltage feedback input in discharge mode. |
| 18 | VLIM | Input voltage limit setting in charge mode. |
| 19 | VNTC | Pull-up bias voltage of the NTC resistive divider. |
| 20 | NTC | Battery temperature sense input. |
| 21 | IB | Current output for the battery current monitor. Using IB for a light-load monitor in discharge mode is recommended. |
| 22 | OLIM | Discharge output current limit setting. Connect an external resistor to AGND to program the system current. |
| 23 | ISET | Charge current set. Connect an external resistor to AGND to program the charge current. |
| 24 | ILIM | Input current limit set. Connect an external resistor to AGND to program the input current. |
| 25 | ACOK | Valid input supply indicator. an open-drain output. ACOK is pulled LOW when the input voltage is recognized as a good source. (see details in the description) |
| 26 | CHGOK | Charging completion indicator. Logic LOW indicates charge mode. The pin becomes an open drain once the charging has completed or is suspended. |



ABSOLUTE MAXIMUM RATINGS (2)

| | |
|--|------------------------------|
| IN | -0.3V to +20V |
| SW | -0.3V (-2V for 50ns) to +20V |
| BATT | -0.3V to +5.5V |
| BST to SW | -0.3V to +5.5V |
| All Other Pins to AGND | -0.3V to +5.5V |
| Continuous Power Dissipation..... (T _A =+25°C) ⁽³⁾ | 2.97W |
| Junction Temperature | 150°C |
| Lead Temperature (Solder) | 260°C |
| Storage Temperature.... | -65°C to +150°C |

Recommended Operating Conditions (4)

| | |
|--|-----------------|
| IN to PGND | 4V to 16V |
| BATT to PGND | 3V to 4.5V |
| Operating Junction Temp. (T _J) | -40°C to +125°C |

| | | |
|-------------------------------|-----------------------|-----------------------|
| Thermal Resistance (5) | θ_{JA} | θ_{JC} |
| QFN-26 (4mmx4mm) | 42 | 9 °C/W |

Notes:

- 2) Exceeding these ratings may damage the device.
- 3) The maximum allowable power dissipation is a function of the maximum junction temperature T_J (MAX), the junction-to-ambient thermal resistance θ_{JA}, and the ambient temperature T_A. The maximum allowable continuous power dissipation at any ambient temperature is calculated by P_D (MAX) = (T_J (MAX)-T_A)/θ_{JA}. Exceeding the maximum allowable power dissipation will cause excessive die temperature, and the regulator will go into thermal shutdown. Internal thermal shutdown circuitry protects the device from permanent damage.
- 4) The device is not guaranteed to function outside of its operating conditions.
- 5) Measured on JESD51-7, 4-layer PCB.

**ELECTRICAL CHARACTERISTICS** $V_{IN} = 5V$, $T_A = 25^{\circ}C$, unless otherwise noted.

| Parameter | Symbol | Condition | Min | Typ | Max | Units |
|---|-----------------|---|------|-------|------|------------|
| Input Power Characteristics | | | | | | |
| Input under-voltage threshold | V_{IN_UVLO} | V_{IN} falling | | 3.8 | | V |
| UVLO threshold hysteresis | | V_{IN} rising | | 300 | | mV |
| Input over-voltage threshold | V_{IN_OVLO} | V_{IN} rising | | 19.5 | | V |
| Input over-voltage threshold hysteresis | | V_{IN} falling | | 640 | | mV |
| DC/DC Converter | | | | | | |
| Input quiescent current | I_{IN_Q} | MODE = Low, charge termination | | | 2.5 | mA |
| USB suspend mode current | I_{IN_SUSP} | MODE = High, PB is not enabled. | | | 2.5 | mA |
| VCC LDO output | V_{VCC} | $V_{IN}=5V$ | 4.4 | 4.5 | 4.6 | V |
| | | MODE=LOW, $V_{IN}=0$, , $V_{BATT}=3.5V$ | | 3.5 | | V |
| High side N-FET on resistance | R_{ON_Q1} | $T_A=25^{\circ}C$ | | 17 | 35 | m Ω |
| Low side N-FET on resistance | R_{ON_Q2} | $T_A=25^{\circ}C$ | | 25 | 35 | m Ω |
| Reverse blocking N-FET on resistance | R_{ON_RB} | $T_A=25^{\circ}C$ | | 12 | 15 | m Ω |
| Peak current limit for high-side N-FET | I_{HS_PK} | CC mode | 6.7 | 8 | | A |
| | | Pre mode | 2.2 | 4 | | A |
| Peak current limit for low-side N-FET | I_{LS_PK} | Discharge mode | 7.6 | 9.2 | | A |
| Operating frequency | F_{SW} | | 1150 | 1300 | 1450 | kHz |
| Battery Charger | | | | | | |
| Pre-charge threshold | V_{BATT_PRE} | | 2.8 | 3.0 | 3.2 | V |
| Pre-charge threshold hysteresis | | | | 220 | | mV |
| Pre-charge current | I_{PRE} | As the percentage of I_{CC} | | 12.5% | | |
| | | If $I_{CC} < 1.7A$ | | 240 | | mA |
| Constant charge current | I_{CC} | $R_{ISET} = 215k\Omega$ | 0.94 | 1.04 | 1.14 | A |
| | | $R_{ISET} = 86.6k\Omega$ | 2.28 | 2.43 | 2.55 | A |
| | | $R_{ISET} = 47.5k\Omega$ | 4.1 | 4.35 | 4.6 | A |
| Termination charge voltage | V_{BATT_REG} | | 4.33 | 4.35 | 4.37 | V |
| Termination charge current | I_{TERM} | As the percentage of I_{CC} | 5 | 10 | 17.5 | % |
| | | If $I_{CC} < 1.7A$ | | 228 | | mA |

ELECTRICAL CHARACTERISTICS (continued)
V_{IN} = 5V, T_A = 25°C, unless otherwise noted.

| Parameter | Symbol | Condition | Min | Typ | Max | Units |
|---|---------------------------|------------------------------------|------|------|------|-------|
| Auto-recharge threshold | V _{RECH} | | | 4.14 | | V |
| Battery over-voltage threshold | V _{BATT_OVP} | | | 4.60 | | V |
| Battery over-voltage recovery hysteresis | | | | 125 | | mV |
| Thermal Regulation and Protection | | | | | | |
| Thermal shutdown threshold ⁽⁶⁾ | T _{J_SHDN} | | | 155 | | °C |
| Thermal shutdown hysteresis ⁽⁶⁾ | | | | 18 | | °C |
| Thermal regulation threshold ⁽⁶⁾ | T _{J_REG} | | | 134 | | °C |
| JEITA Battery Temperature Protection Threshold | | | | | | |
| NTC low temp rising threshold | V _{COLD} | As percentage of V _{VNTC} | 69.4 | 70 | 70.6 | % |
| NTC low temp rising threshold hysteresis | | As percentage of V _{VNTC} | | 0.80 | | % |
| NTC cool temp rising threshold | V _{COOL} | As percentage of V _{VNTC} | 67.3 | 67.9 | 68.5 | % |
| NTC cool temp rising threshold hysteresis | | As percentage of V _{VNTC} | | 1.25 | | % |
| NTC warm temp falling threshold | V _{WARM} | As percentage of V _{VNTC} | 56.4 | 57 | 57.6 | % |
| NTC warm temp falling threshold hysteresis | | As percentage of V _{VNTC} | | 1.55 | | % |
| NTC hot temp falling threshold | V _{HOT} | As percentage of V _{VNTC} | 48.5 | 49 | 49.5 | % |
| NTC hot temp falling threshold hysteresis | | As percentage of V _{VNTC} | | 1.50 | | % |
| Input Voltage and Input Current Regulation | | | | | | |
| Input current limit | I _{IN_LIM} | R _{LIM} = 475kΩ | 400 | 453 | 500 | mA |
| | | R _{LIM} = 154kΩ | 1260 | 1366 | 1500 | mA |
| | | R _{LIM} = 73.2kΩ | 2680 | 2856 | 3000 | mA |
| Feedback voltage reference | V _{IN_MIN_REF} | | 1.18 | 1.2 | 1.22 | V |
| Discharge Mode | | | | | | |
| Feedback voltage reference | V _{IN_DSCHG_REF} | | 1.18 | 1.2 | 1.22 | V |
| Feedback input current | I _{FB_LKG} | Sink into this pin | | | 420 | nA |
| Output over-voltage threshold reference | V _{INOVP_DSCHG} | V _{OUT} < 7V | | 1.41 | | V |
| | | V _{OUT} > 7V | | 1.35 | | V |
| Output over-voltage threshold hysteresis | | | | 32 | | mV |

ELECTRICAL CHARACTERISTICS (continued)
V_{IN} = 5V, T_A = 25°C, unless otherwise noted.

| Parameter | Symbol | Condition | Min | Typ | Max | Units |
|--|------------------------|---|-----|------|------|-------|
| Battery shutdown current | I _{BATT_SHDN} | MODE=high, switching is disabled. | | | 20 | μA |
| Programmable output current limit | I _{IN_DSCHG} | R _{OLIM} = 374kΩ | 0.5 | 0.57 | 0.65 | A |
| | | R _{OLIM} = 133kΩ | 1.5 | 1.6 | 1.7 | A |
| | | R _{OLIM} = 68.1kΩ | 3 | 3.12 | 3.3 | A |
| Battery UV threshold | V _{BATT_UVLO} | V _{BATT} falling when discharging | | 3 | | V |
| | | V _{BATT} rising before discharging start | | 2.7 | | V |
| IB voltage output | V _{IBATT} | I _{DIS} =80mA, R _{IB} = 80kΩ, in boost mode | 65 | 80 | 95 | mV |
| Logic I/O Pin Characteristics | | | | | | |
| ACOK, CHGOK, pin output low voltage | | Sinking 1.5mA | | | 400 | mV |
| ACOK, CHGOK, pin leakage current | | Connected to 5V | | | 1 | μA |
| MODE input logic low voltage | | | | | 0.4 | V |
| MODE input high voltage | | | 1.4 | | | V |
| Timing Characteristics | | | | | | |
| LED blinking frequency ⁽⁶⁾ | | I _{CHG} = 1A | | 1 | | Hz |
| Pre-charge time | t _{TMR_PRE} | C _{TMR} =0.1μF, Stay in pre-charge Mode, I _{CHG} = 1A | | 32.5 | | Mins |
| Total charge time | t _{TMR} | C _{TMR} =0.1μF, I _{CHG} = 1A | | 370 | | Mins |
| Threshold between long and short touch | | | | 2.5 | | s |
| LED auto-off timer delay | | | | 5 | | s |



ELECTRICAL CHARACTERISTICS (continued)

V_{IN} = 5V, T_A = 25°C, unless otherwise noted.

| Parameter | Symbol | Condition | Min | Typ | Max | Units |
|---|--------|-------------------------|-----|------|-----|-------|
| Voltage Based Fuel Gauge Threshold | | | | | | |
| Charge Mode | | | | | | |
| First level of battery voltage threshold | | Battery voltage rising | | 3.83 | | V |
| Hysteresis | | | | 306 | | mV |
| Second level of battery voltage threshold | | Battery voltage rising | | 4.04 | | V |
| Hysteresis | | | | 300 | | mV |
| Third level of battery voltage threshold | | Battery voltage rising | | 4.25 | | V |
| Hysteresis | | | | 295 | | mV |
| Discharge Mode | | | | | | |
| Fourth level of battery voltage threshold | | Battery voltage falling | | 4.14 | | V |
| Hysteresis | | | | 298 | | mV |
| Third level of battery voltage threshold | | Battery voltage falling | | 3.93 | | V |
| Hysteresis | | | | 305 | | mV |
| Second level of battery voltage threshold | | Battery voltage falling | | 3.73 | | V |
| Hysteresis | | | | 305 | | mV |
| First level of battery voltage threshold | | Battery voltage falling | | 3.11 | | V |
| Hysteresis | | | | 305 | | mV |

Notes:

6) Guaranteed by design.

TYPICAL PERFORMANCE CHARACTERISTICS

$V_{IN} = 5V$, $T_A = 25^\circ C$, unless otherwise noted.

Constant Current Charge Efficiency

$I_{CHG}=5A$ with $R_{ISET}= 42.2k\Omega$,
 $I_{NLIM}=3A$ with $R_{LIMIT}= 71.2k\Omega$

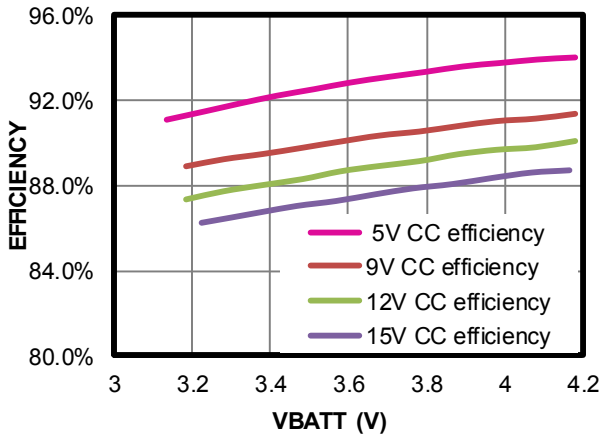

Constant Voltage Charge Efficiency

$V_{BATT}=4.35V$, $R_{LIMIT}= 71.2k\Omega$, $R_{ISET}= 42.2k\Omega$

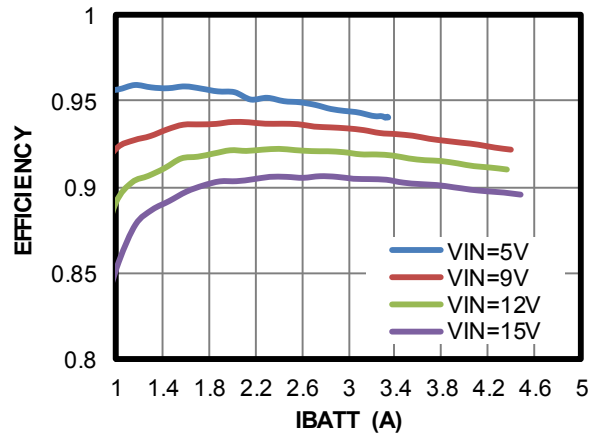

BOOST Efficiency

$V_{BATT}= 3.7V$

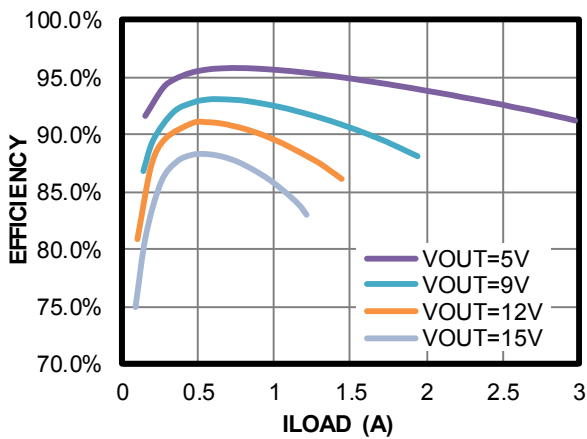

Programmable Charge Current, Charge Mode

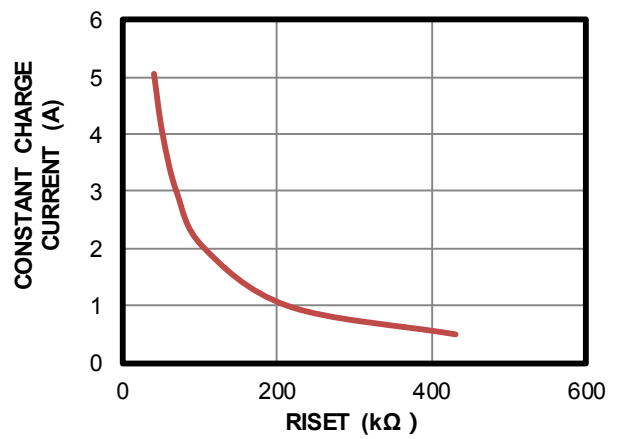

Programmable Input Current Limit, Charge Mode

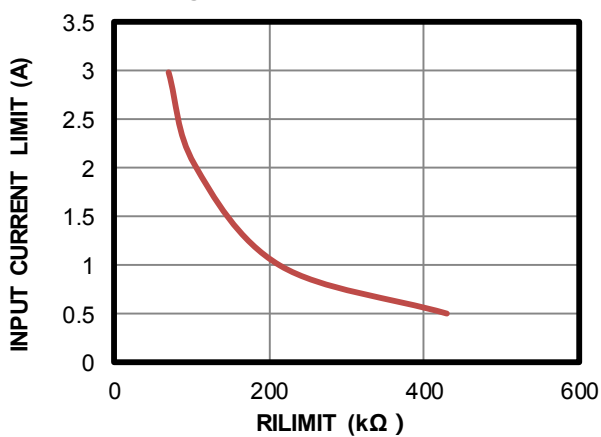

Programmable Output Current Limit, BOOST Mode

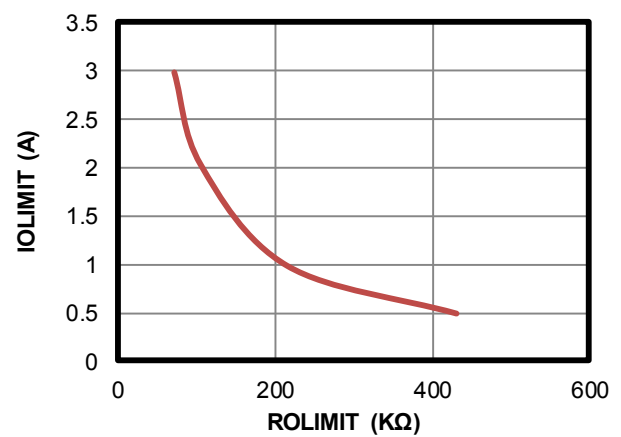

TYPICAL PERFORMANCE CHARACTERISTICS (continued)
 $V_{IN} = 5V$, $T_A = 25^{\circ}C$, unless otherwise noted.

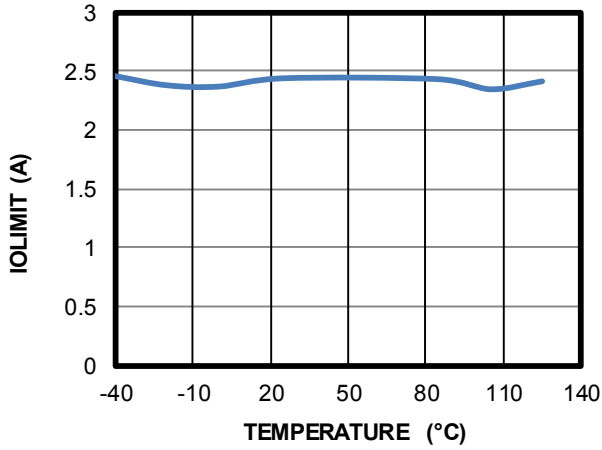
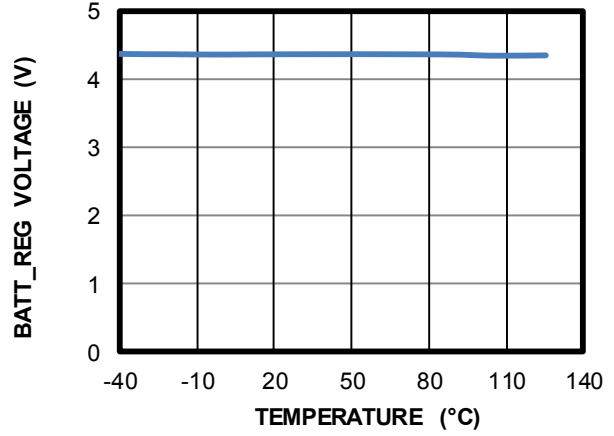
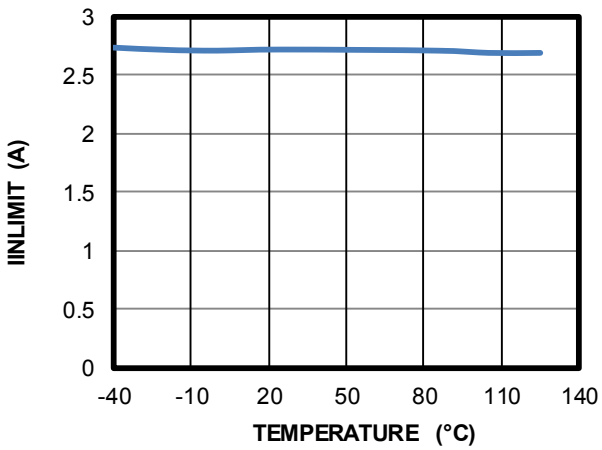
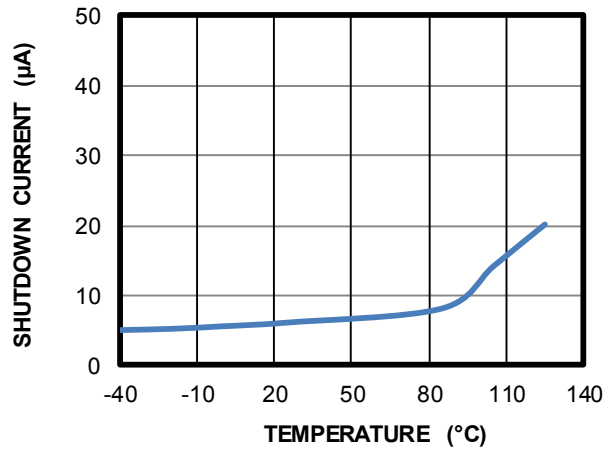
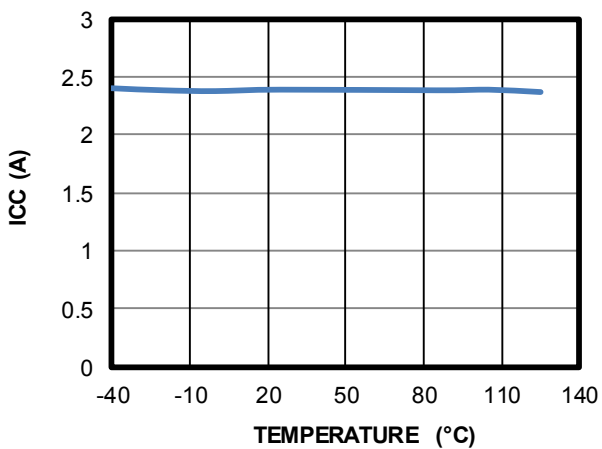
IOLIMIT vs. Temperature

BATT_REG Voltage vs. Temperature

IINLIMIT vs. Temperature

Shutdown Current vs. Temperature

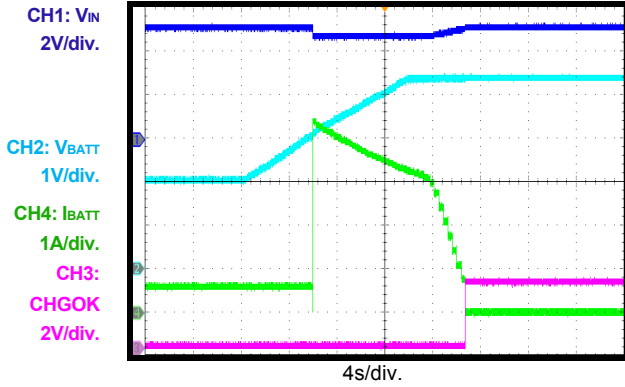
ICC vs. Temperature

TYPICAL PERFORMANCE CHARACTERISTICS (continued)

$V_{IN} = 5V$, $T_A = 25^\circ C$, $V_{BATT_REG} = 4.35V$, unless otherwise noted.

Battery Charge Curve
 $V_{IN} = 5V$, $R_{LIM} = 71.5k\Omega$, $R_{SET} = 42.2k\Omega$



Auto Recharge
 $V_{IN} = 5V$, $R_{LIM} = 71.5k\Omega$, $R_{SET} = 42.2k\Omega$

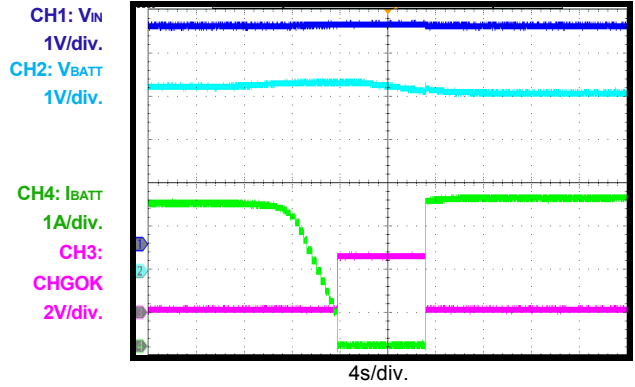

Battery Charge Curve
 $V_{IN} = 15V$, $R_{LIM} = 71.5k\Omega$, $R_{SET} = 42.2k\Omega$

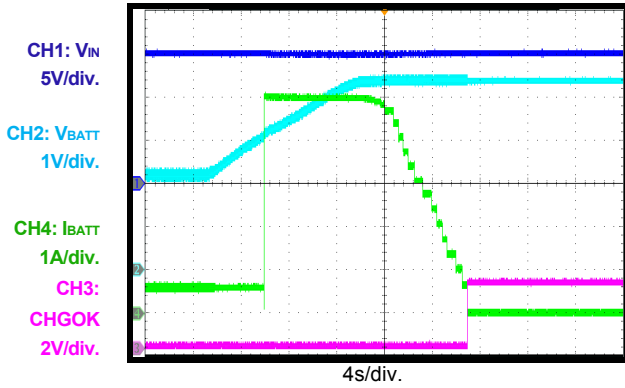

Auto Recharge
 $V_{IN} = 15V$, $R_{LIM} = 71.5k\Omega$, $R_{SET} = 42.2k\Omega$

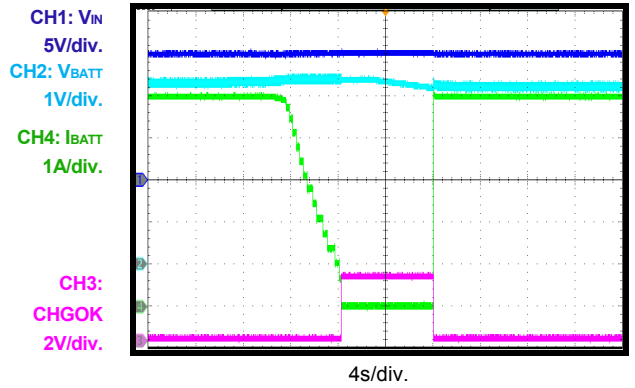

TC Charge Steady State
 $V_{IN} = 15V$, $V_{BATT} = 2.6V$, $R_{LIM} = 71.5k\Omega$,
 $R_{SET} = 42.2k\Omega$

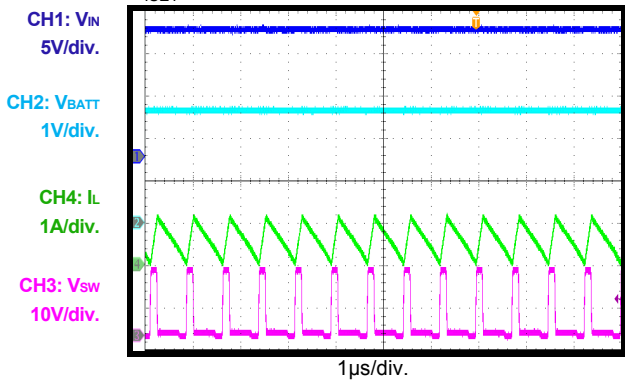

CC Charge Steady State
 $V_{IN} = 15V$, $V_{BATT} = 3.7V$, $R_{LIM} = 71.5k\Omega$,
 $R_{SET} = 42.2k\Omega$

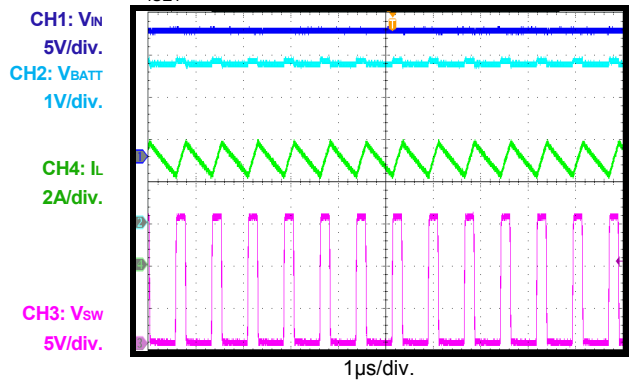

TYPICAL PERFORMANCE CHARACTERISTICS (continued)

$V_{IN} = 5V$, $T_A = 25^\circ C$, unless otherwise noted.

Power On, Charge Mode
 $V_{IN}=15V$, $V_{BATT}=3.7V$, $R_{LIM}=71.5k\Omega$,
 $R_{SET}=42.2k\Omega$

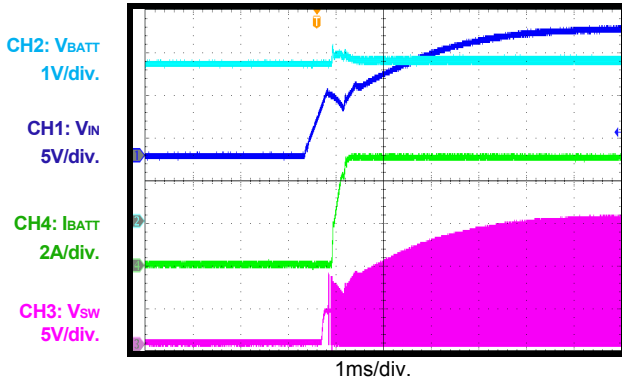

Power Off, Charge Mode
 $V_{IN}=15V$, $V_{BATT}=3.7V$, $R_{LIM}=71.5k\Omega$,
 $R_{SET}=42.2k\Omega$

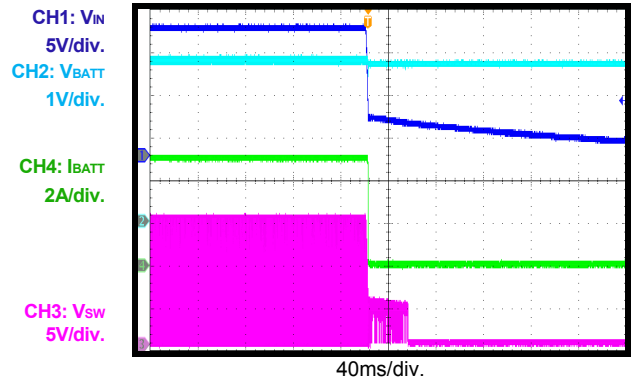

NTC Protection in Charge Mode
 $V_{IN}=5V$, $V_{BATT}=4.1V$, $R_{LIM}=14.7k\Omega$

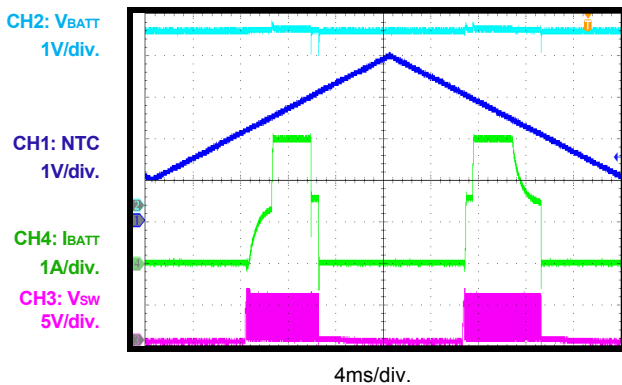

Fuel Gauge Indication During Charging
 $V_{IN}=5V$, $V_{BATT}=3.7V$, $R_{LIM}=71.5k\Omega$,
 $R_{SET}=71.5k\Omega$, V_{BATT} offset 3.7V

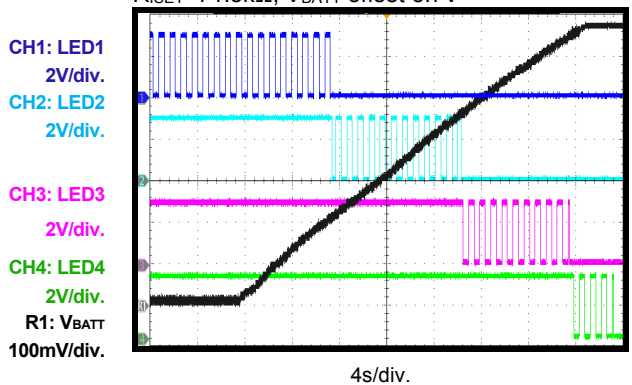

NTC Fault Indication, Charge Mode
 $V_{IN}=5V$, $V_{BATT}=3.7V$, $R_{LIM}=71.5k\Omega$,
 $R_{SET}=71.5k\Omega$

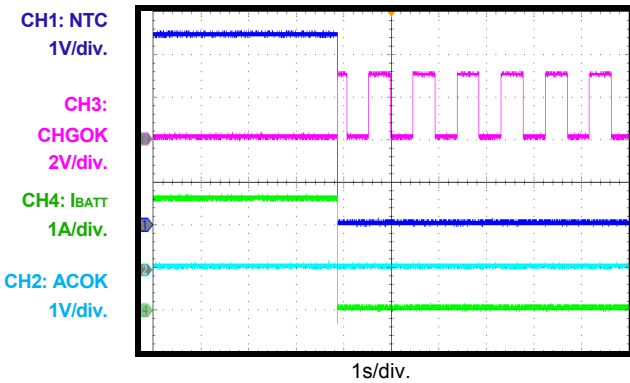

Timer Out Fault Indication, Charge Mode
 $V_{IN}=5V$, $V_{BATT}=3.7V$, $CTMR=150pF$

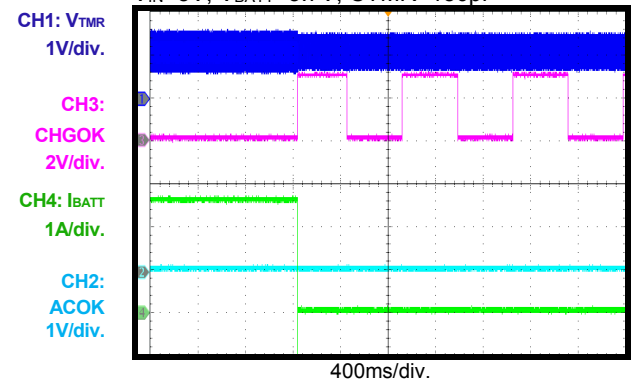

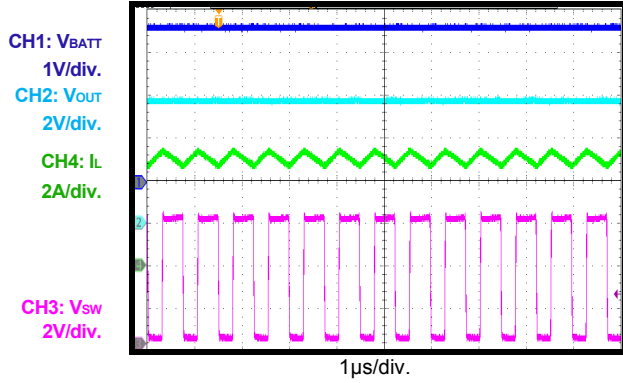
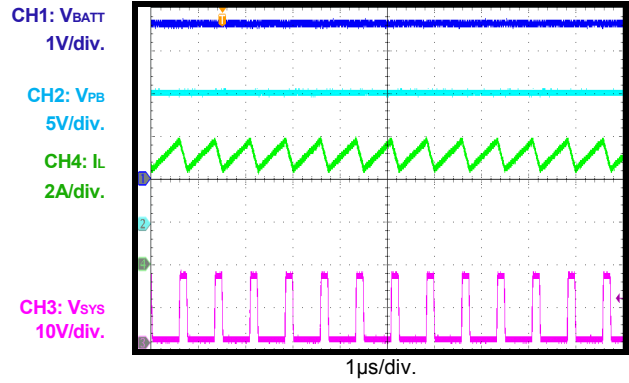
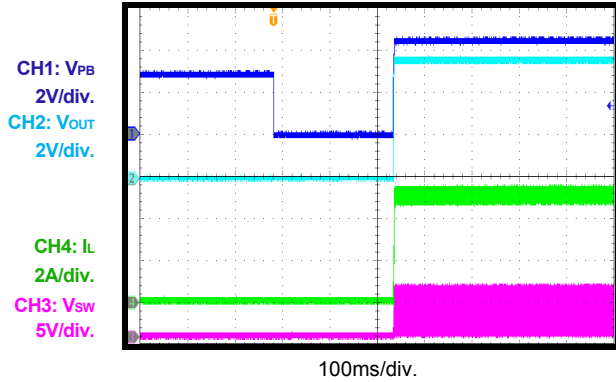
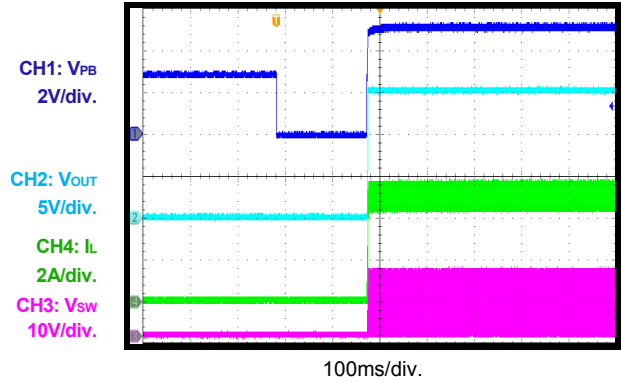
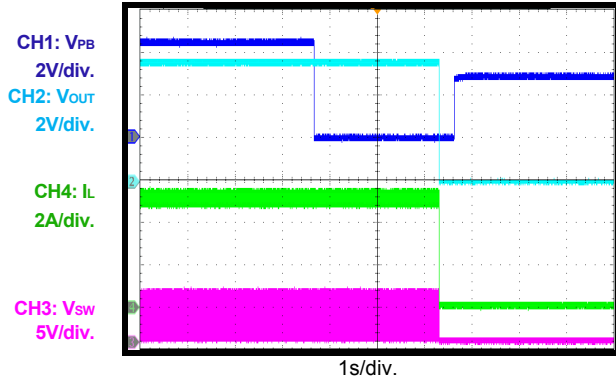
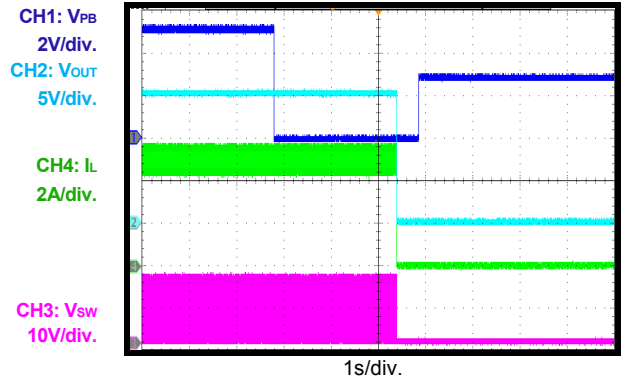
TYPICAL PERFORMANCE CHARACTERISTICS (continued)
 $V_{IN} = 5V$, $T_A = 25^\circ C$, unless otherwise noted.
BOOST Mode Steady State
 $V_{BATT}=3.7V$, $V_{OUT}=5V$, $R_{OLIMIT}=71.5k\Omega$,
 $I_{LOAD}=3A$

BOOST Mode Steady State
 $V_{BATT}=3.7V$, $V_{OUT}=15V$, $R_{OLIMIT}=71.5k\Omega$,
 $I_{LOAD}=1A$

Power On by PB Pin, BOOST Mode
 $V_{BATT}=3.7V$, $V_{OUT}=5V$, $R_{OLIMIT}=71.5k\Omega$,
 $I_{LOAD}=3A$

Power On by PB Pin, BOOST Mode
 $V_{BATT}=3.7V$, $V_{OUT}=15V$, $R_{OLIMIT}=71.5k\Omega$,
 $I_{LOAD}=1A$

Power Off by PB Pin, BOOST Mode
 $V_{BATT}=3.7V$, $V_{OUT}=5V$, $R_{OLIMIT}=71.5k\Omega$,
 $I_{LOAD}=3A$

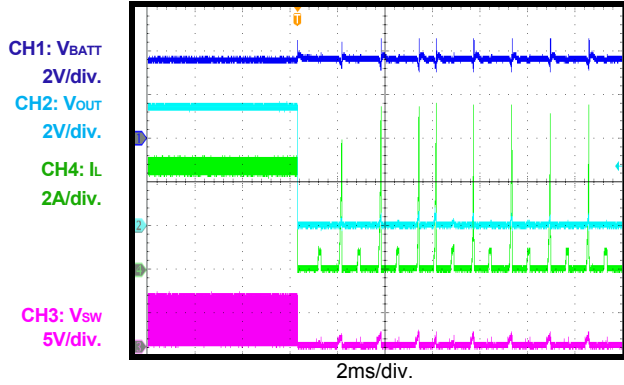
Power Off by PB Pin, BOOST Mode
 $V_{BATT}=3.7V$, $V_{OUT}=15V$, $R_{OLIMIT}=71.5k\Omega$,
 $I_{LOAD}=1A$

TYPICAL PERFORMANCE CHARACTERISTICS (continued)

$V_{IN} = 5V$, $T_A = 25^\circ C$, unless otherwise noted.

SYS Short-Circuit Entry

$V_{BATT}=3.7V$, $V_{OUT}=5V$, $R_{OLIMIT}=71.5k\Omega$, $I_{LOAD}=3A$



SYS Short-Circuit Recovery

$V_{BATT}=3.7V$, $V_{OUT}=5V$, $R_{OLIMIT}=71.5k\Omega$, $I_{LOAD}=3A$

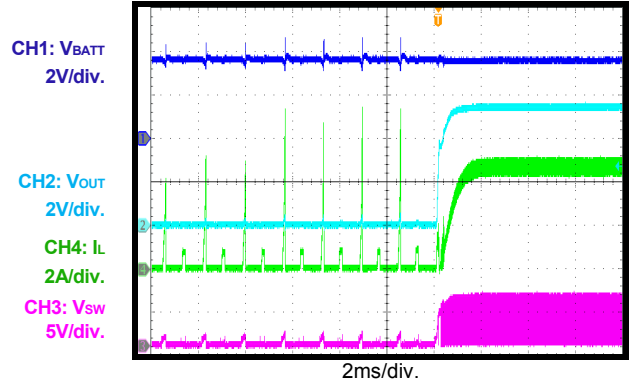

Load Transient

$V_{BATT}=4V$, $V_{OUT}=5V$, V_{OUT} offset 5V, $I_{LOAD}=0.2A-2.5A$, transient rate=1600mA/ μs

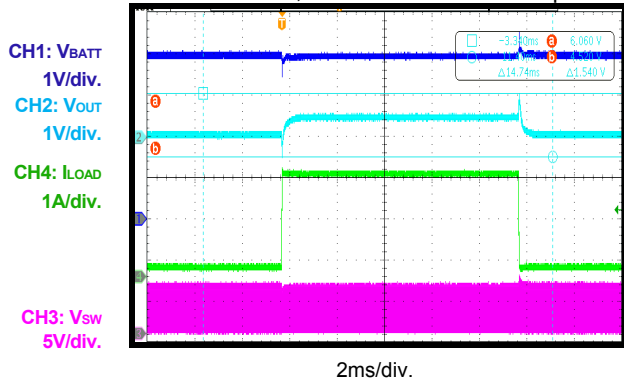

LED Indication, BOOST Mode

V_{BATT} ramping down, $V_{OUT}=5V$, $I_{LOAD}=0A$, V_{BATT} offset 3V

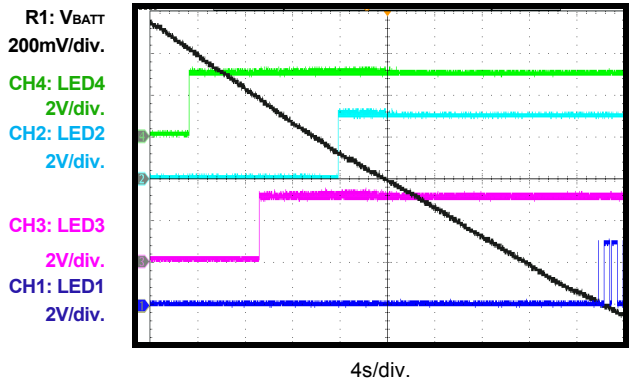

BLOCK DIAGRAM

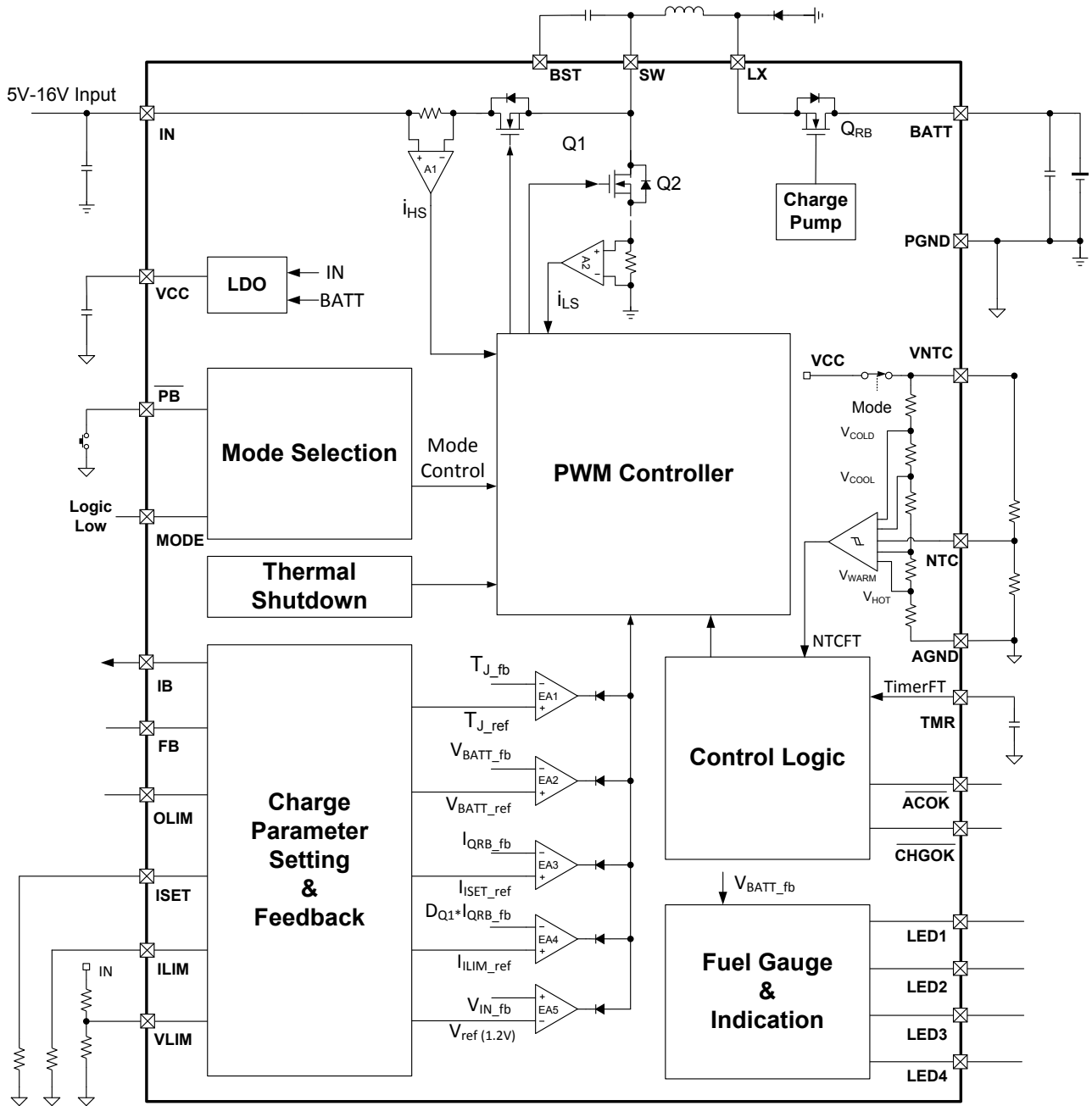

Figure 1: Block Diagram for Charge Mode

BLOCK DIAGRAM (continued)

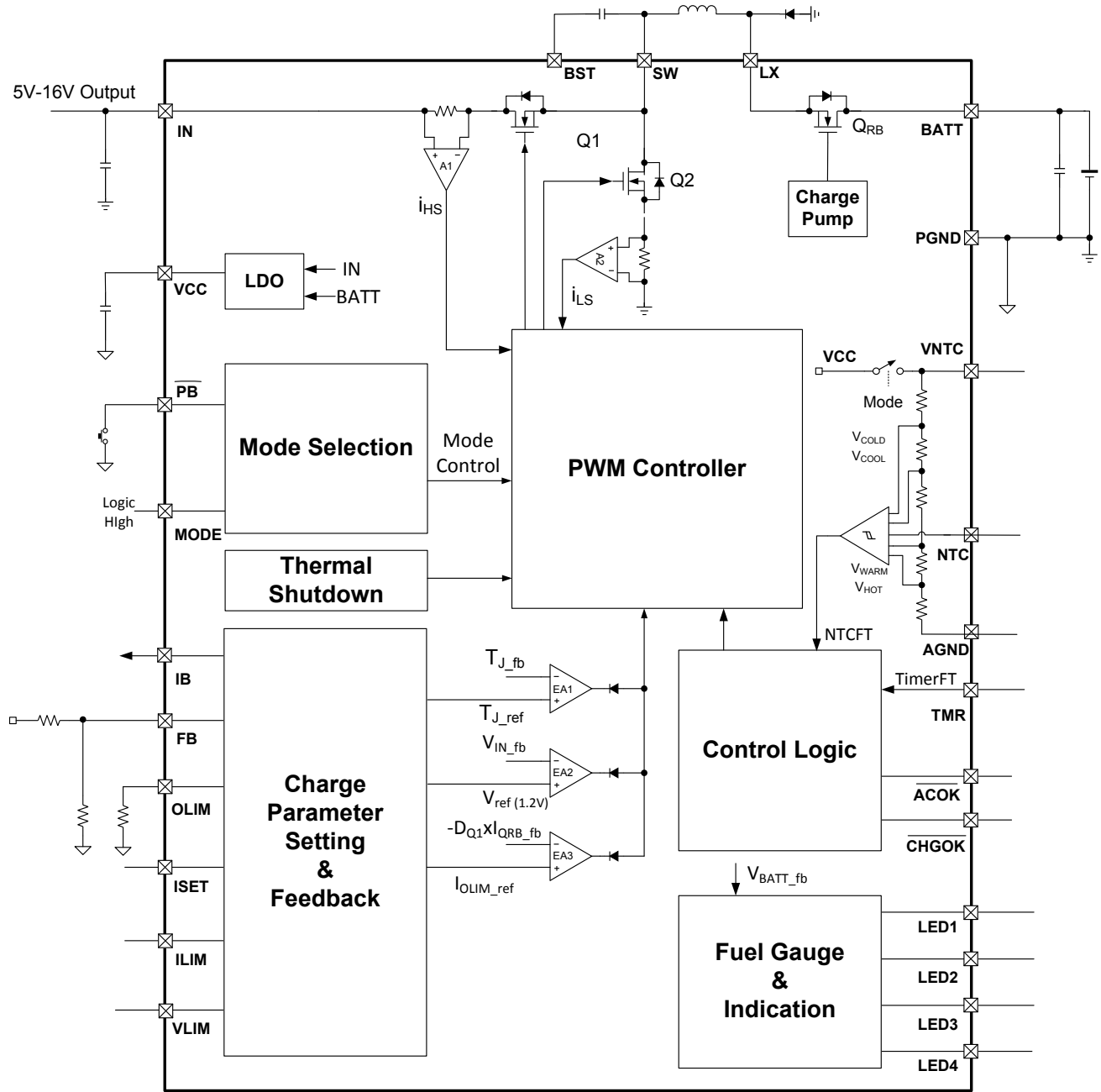

Figure 2: Block Diagram for Discharge Mode

OPERATION

Introduction

The MP2639B is a highly integrated switch-mode battery charger with a sophisticated control strategy to charge 1- cell Lithium-ion or Lithium-polymer batteries from a wide input voltage range. Also, the MP2639B can be discharged to the input by boosting up the battery voltage from 5V to 16V.

MODE Control

When mode is low, the MP2639B operates in charging mode to charge a 1- cell battery from 5V to 16V, while operating in step-down mode; Q1 operates as the active switch; Q2 operates as the synchronous switch.

When mode is high, the MP2639B is configured to discharge mode. Once the push-button block determines the discharge is enabled, the MP2639B operates in reverse to get a 5V to 16V output from a 1- cell battery via step-up mode.

Table 1 on page 2 shows the control logic of operation mode.

Internal Power Supply

The VCC output is used to power the internal circuit and the MOSFET driver. VCC is supplied by the higher terminal voltage between V_{BATT} and V_{IN} . Connect an external capacitor from VCC to AGND. The VCC output is not able to carry an external load.

CHARGE MODE

Input Power Start-up

Once the VCC voltage exceeds the UVLO threshold, the MP2639B qualifies both the BATT and IN voltage according to the MODE status.

In charging mode, once $V_{OVLO} > V_{IN} > V_{UVLO}$, $V_{IN} > V_{BATT} + 400\text{mV}$ and no fault occurs, the MP2639B is ready for charging.

The MP2639B provides three main charging phases: pre-charge, constant-current charge, and constant-voltage charge (see Figure 3).

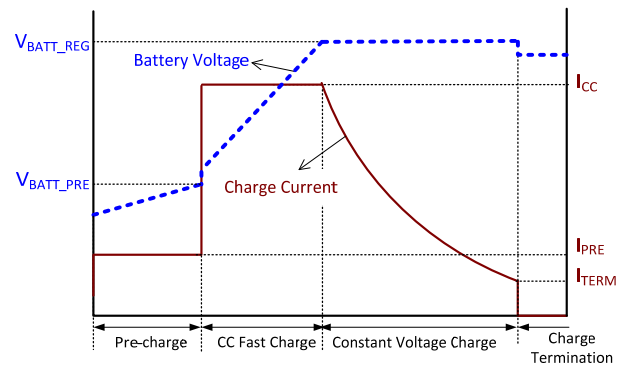

Figure 3 Charging Profile

Phase 1 (Pre-Charge)

When the battery voltage is lower than V_{BATT_PRE} , the MP2639B applies a safe pre-charge current (I_{PRE}) to the depleted battery until the battery voltage reaches the pre-charge to fast charge threshold (V_{BATT_PRE}). If V_{BATT_PRE} is not reached before the pre-charge timer expires (1hr), the charge cycle is ceased and a corresponding timeout fault signal is asserted.

Phase 2 (Constant-Current Charge)

When the battery voltage exceeds V_{BATT_PRE} , the MP2639B stops the pre-charge phase and enters constant-current charge (fast charge) phase with soft start. The fast charge current can be programmed by ISET.

Phase 3 (Constant-Voltage Charge)

When the battery voltage rises to the programmable charge termination voltage V_{BATT_REG} , the charge current begins to taper off. The charge cycle is considered complete when the CV loop is dominated and the charge current reaches the battery full termination threshold. Also, a $500\mu\text{s}$ force charge time is designed for each charge cycle; after the $500\mu\text{s}$ force charge time expires, the charge full signal is asserted.

If I_{TERM} is not reached before the safety charge timer expires (**see Safety Timer section**), the charge cycle is ceased and the corresponding timeout fault signal is asserted.

A new charge cycle starts when the following conditions are valid:

- The input power is re-plugged.
- The MODE pin is toggled from HIGH to LOW.
- The auto-recharge signal is launched

- No thermistor fault at NTC pin.
- No safety timer fault
- No battery over-voltage fault

Automatic Recharge

When the battery is fully charged and the charging is terminated, the battery may be discharged for the system consumption or self-discharge. The MP2639B automatically starts a new charging cycle without the requirement of manually re-starting a charging cycle.

Charge Current Setting

ISET is used to program the fast constant-charge current. See equation (1) for the charge current setting formula:

$$I_{CC} = \frac{640k}{3 \times R_{ISET}(k)} \quad (1)$$

Battery Over-Voltage Protection

The MP2639B is designed with a built-in battery over-voltage limit of 4.59V, typically. When the battery over-voltage event occurs, the MP2639B suspends the charging immediately.

Safety Timer

The MP2639B uses an internal timer to terminate the charging. The timer remains active during the charging process. An external capacitor between TMR and AGND programs the charge cycle duration. There is an internal current source which charges and discharges the external capacitor alternatively. When the voltage across the C_{TMR} is lower than 0.7V, the internal current source charges the C_{TMR}. Once the voltage exceeds 1.5V, the internal current source begins to discharge the C_{TMR}. As a result the voltage across the C_{TMR} oscillates periodically between 0.7V and 1.5V like a triangle wave (see Figure 4).

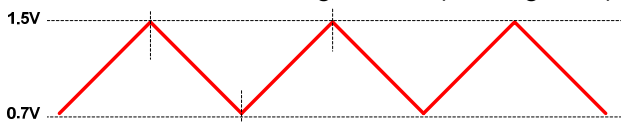

Figure 4: Voltage Profile at TMR Pin

There are two counter limits for the pre-charge and total charge process: 45056 for pre-charge and 3407872 for CC and CV charge. Once the counter reaches the corresponding limit, the timer expires, and the charging is suspended.

In pre-charge mode, the pre-charge time t_{TMR_PRE} is set using equation (2):

$$t_{TMR_PRE} = 33.7 \text{ min s} \times \frac{C_{TMR}}{0.1\mu\text{F}} \quad (2)$$

In CC and CV mode, the internal I_{OSC} is proportional to the reference of the charge current set by ISET, and it is independent of the real charge current or input current. The total charge time t_{TMR} is set using equation (3):

$$t_{TMR} = 6.05 \text{ hours} \times \frac{C_{TMR}}{0.1\mu\text{F}} \times \frac{1\text{A}}{I_{CHG} + 0.08} \quad (3)$$

In the event of a NTC hot and cold fault, the charging timer is suspended. Once the NTC fault is removed, the timer continues to count from the value before the NTC fault.

NTC (Negative Temperature Coefficient) Thermistor

“Thermistor” is the generic name given to thermally sensitive resistors. A negative temperature coefficient thermistor is called a thermistor, generally. Depending on the manufacturing method and the structure, there are many shapes and characteristics available for various applications. The thermistor resistance values, unless otherwise specified, are classified at a standard temperature of 25°C. The resistance of a temperature is solely a function of its absolute temperature.

Refer to the thermistor datasheet. The mathematic expression which relates the resistance and the absolute temperature of a thermistor is shown in equation (4):

$$R_{t1} = R_{t2} \times e^{\beta \left(\frac{1}{t_1} - \frac{1}{t_2} \right)} \quad (4)$$

Where: R_{t1} is the resistance at absolute temperature (t₁), R_{t2} is the resistance at absolute temperature (t₂) and β is a constant, which depends on the material of the thermistor.

The MP2639B monitors the battery’s temperature continuously by measuring the voltage at NTC during charge mode. This voltage is determined by the resistive divider whose ratio is produced by the different resistances of the NTC thermistor under different ambient temperatures of the battery.

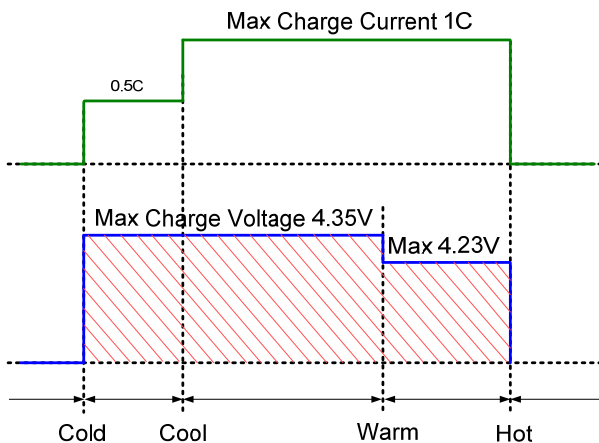
Figure 5: JEITA Compatible NTC Window

The MP2639B internally sets a pre-determined upper and lower range. If the voltage at NTC goes out of this range, it means the temperature is outside the safe operating limit. At this time, the charging stops unless the operating temperature returns to a safe range.

To satisfy the JEITA requirement, the MP2639B monitors four temperature thresholds (see Figure 5): cold battery threshold T1, cool battery threshold T2, warm battery threshold T3, and hot battery threshold T4. For a given NTC thermistor, these temperatures correspond to V_{COLD} , V_{COOL} , V_{WARM} , and V_{HOT} . When $V_{NTC} < V_{HOT}$ or $V_{NTC} > V_{COLD}$, the charging is suspended and the timers are suspended. When $V_{HOT} < V_{NTC} < V_{WARM}$, the charge full voltage V_{BATT_REG} is reduced by 120mV from the programmable threshold. When $V_{COOL} < V_{NTC} < V_{COLD}$, the charging current is reduced to half of the programmable charge current.

Note: V_{NTC} is the ratio of the voltage at NTC pin and the voltage at VNTC pin.

VNTC Output

VNTC is the input pin used to pull up both the internal and external resistive divider to the same point. The VNTC is connected to VCC via an internal switch. In charging mode, the switch is turned on, and the VNTC is connected to VCC. In discharging mode, the switch is off, and VNTC is bridged off from VCC (see Figure 6).

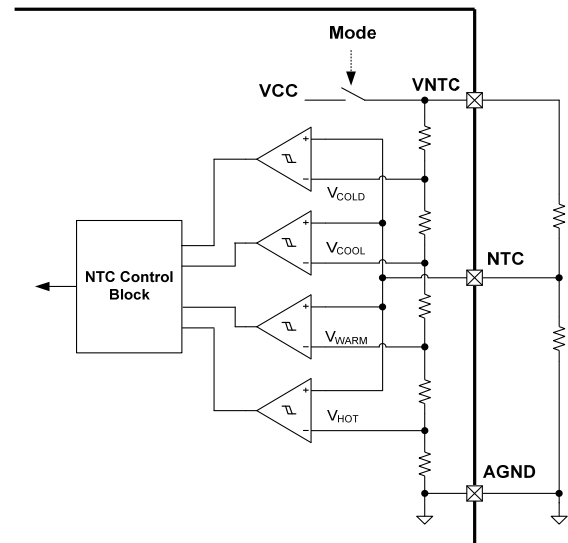
Figure 6: Diagram of NTC Protection Circuit

Input Voltage Based and Input Current Based Power Management

To meet the USB maximum current limit specification and avoid over loading the adapter, the MP2639B features both the input current- and input voltage- based power management by continuously monitoring the input current and input voltage. The total input current limit can be programmed to prevent the input source from overloading. When the input current hits the limit, the charge current tapers off to keep the input current from increasing further. The input current limit is shown in equation (5):

$$I_{IN_LMT} = \frac{640k}{3 \times R_{ILIM}(k)} \quad (5)$$

If the pre-set input current limit is higher than the rating of the adapter, the back-up input voltage based power management also works to prevent the input source from being overloaded. When the input voltage falls below the input voltage limit due to over loading, the charge current is also reduced to keep the input voltage from dropping further.

The input voltage clamp threshold can be programmed by VLIM. The internal reference of the input voltage loop is 1.2V, so the input voltage clamp limit is calculated with equation (6):

$$V_{IN_MIN} = 1.2V \times \frac{R3 + R4}{R4} \quad (6)$$

Indication

The MP2639B integrates indicators for the conditions in Table 2.

Table 2: Integrated Indicators

| Mode | Charging State | ACOK | CHGOK |
|------|--|------------|-----------------|
| LOW | In Charging | LOW | LOW |
| | <ul style="list-style-type: none"> Charging complete Sleep mode Charge disable Battery OVP | LOW | Open Drain |
| | <ul style="list-style-type: none"> NTC Cold fault NTC Hot fault Timer Fault | LOW | Blinking at 1Hz |
| HIGH | Discharging | Open Drain | Open Drain |

DISCHARGE MODE

Discharge Control

When MODE is configured high, discharge mode is ready. Only when the push-button pin is configured properly can the discharging be enabled or disabled.

A short-push is when the push-button pin is pulled low for less than 2.5s. A long-push is when the push-button pin is pulled low for longer than 2.5s. (See below)

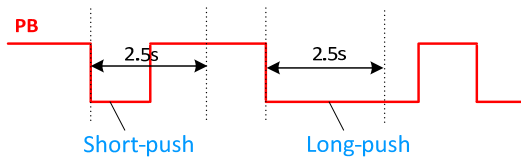

In the MP2639B, the discharging is enabled only when MODE is high, and a short-push is detected. The discharging is disabled once MODE is pulled to low or a long-push is detected (see Figure 7):

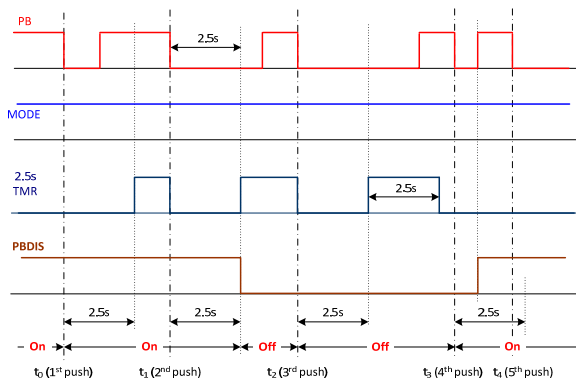

Figure 7: PB Behavior

- i) Before t_0 , MODE is high and discharging has been enabled. Where PBDIS is the internal enable signal of the discharging. If PBDIS is high, the discharging is enabled.
- ii) At t_0 , PB is pulled low and a 2.5s timer is reset. PB is released high before a 2.5s timer runs out, so that a short-push is detected. The PBDIS remains high and discharging continues.
- iii) At t_1 , PB is pulled low again, and a 2.5s timer is reset. Since PB remains low until the 2.5s timer runs, a long-push is detected, so PBDIS is pulled low and discharging stops.
- iv) At t_2 , another long-push is detected, so PBDIS remains low and discharging remains disabled.
- v) At t_3 , a short-push occurs, and PBDIS becomes high once PB jumps high; discharging is enabled.

Since the MP2639B stays in sleep mode if PB is pulled down to GND for less than 2.5s (marked as a short push), the IC enters discharging mode, and the LEDs display the battery capacity. After 5s, the LED pins become an open-drain automatically to minimize the battery quiescent current.

For the LED to display the battery capacity, short push PB.

USB OTG

When the discharge function is enabled, the MP2639B is able to step the battery voltage up to 16V, which covers the USB PD2.0 output voltage levels of 5V, 9V, 12V and 15V. By connecting a MCU or PD controller GPIO to FB via a resistor, it can support PPS (programmable power supply) adjustable output voltage levels.

Output Over-Voltage Protection

The MP2639B has an inner output over-voltage protection. If the voltage at the IN node is higher than the over-voltage protection threshold, and an abnormal external voltage is added or FB is pulled to AGND incorrectly, the MP2639B disables the discharge and turns off the Q_{RB} FET. When the output voltage returns to a safe level, the MP2639B restarts the discharging.

Output Over-Current Limit

The MP2639B features an output over-current limit, which can be programmed by the resistor connected from OLIM to AGND. When the output current flowing out from the IN node exceeds the output over-current limit, the MP2639B regulates the duty cycle to maintain the output current at this limit, so that the output voltage drops accordingly. The output current limit setting formula is shown in equation (7):

$$I_{OUT_REG_DCHG} = \frac{640k}{3 \times R_{OLIM}(k)} \quad (7)$$

Output Short-Circuit Protection

The MP2639B monitors the IN voltage continuously. If IN drops lower than 3.9V, an output short circuit is detected, and the peak current of the low-side switch is cut by half.

Voltage-Based Fuel Gauge

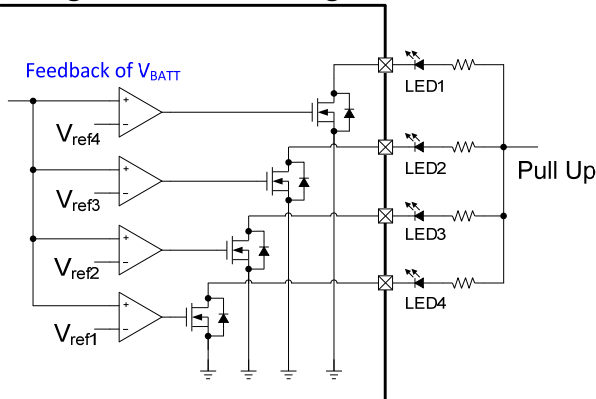

Figure 8: Internal Diagram of LED Indication Control

The MP2639B integrates four comparators and open-drain circuits to indicate the rough fuel gauge via four LEDs during both charge and discharge (see Figure 8). The MP2639B compares the battery voltage with four voltage references to reveal the capacity the battery stays within. The four options are 25%, 50%, 75%, 100%. The LED indication in charge mode is shown in Table 3.

Table 3: LED Indication in Charge Mode

| Charge | LED1 | LED2 | LED3 | LED4 | CHGOK |
|-----------------------------------|-----------------|-----------------|-----------------|-----------------|-------|
| Done | On | On | On | On | Off |
| 4.35V | On | On | On | On | On |
| 4.25V < V _{BATT} < 4.35V | On | On | On | Blinking at 1Hz | On |
| 4.04V < V _{BATT} < 4.25V | On | On | Blinking at 1Hz | Off | On |
| 3.83V < V _{BATT} < 4.04V | On | Blinking at 1Hz | Off | Off | On |
| V _{BATT} < 3.83V | Blinking at 1Hz | Off | Off | Off | On |

In discharge mode, to minimize the power consumption of the gauge indication, the indication control is achieved by PB. When PB is short pushed, the gauge indication is enabled and disabled after 5s automatically (see Table 4):

Table 4: LED Indication in Discharge Mode

| Discharge | LED1 | LED2 | LED3 | LED4 | CHGOK |
|-----------------------------------|-----------------|------|------|------|-------|
| 4.14V < V _{BATT} | On | On | On | On | Off |
| 3.94V < V _{BATT} < 4.14V | On | On | On | Off | Off |
| 3.73V < V _{BATT} < 3.94V | On | On | Off | Off | Off |
| 3.11V < V _{BATT} < 3.73V | On | Off | Off | Off | Off |
| V _{BATT} < 3.11V | Blinking at 1Hz | Off | Off | Off | Off |

Discharge Line Drop Compensation

The MP2639B integrates the discharge line compensation function to compensate for a voltage-drop across the cable automatically. The output voltage is compensated by feeding the output current to the top feedback resistance (R1). If the trace to the load is long, there is a voltage drop between V_{OUT} and V_{LOAD}. V_{OUT} (voltage at output terminator) is not equal to V_{LOAD} (voltage at load). The voltage drop can be calculated with equation (8):

$$V_{LOAD} = V_{OUT} - I_{OUT} \times R_{TRACE} \quad (8)$$

Where, the R_{TRACE} is the resistance of the cable.

To keep an accurate and constant load voltage, the output line drop compensation is necessary. The MP2639B offers a compensation method by adjusting the FB voltage slightly according to the load current. The relation between V_{OUT} and V_{FB} can be calculated with equation (9):

$$\frac{V_{OUT} - V_{FB}}{R_1} = \frac{V_{IN_REF_DCHG}}{R_2} + \frac{V_{IOUT}}{R_X} \quad (9)$$

Where V_{IOUT} is the voltage signal representing the real output current. The output voltage after compensation is calculated with equation (10):

$$V_{OUT} = \frac{R_1 + R_2}{R_2} \times V_{IN_REF_DCHG} + \frac{I_{OUT} \times K_{SNS}}{R_X} \times R_1 \quad (10)$$

To ensure V_{LOAD} is always equal to the output setting voltage $V_{IN_REF_DCHG} \times (R_1 + R_2) / R_2$, use equation (11):

$$\frac{I_{OUT} \times K_{SNS}}{R_X} \times R_1 = I_{OUT} \times R_{TRACE} \quad (11)$$

If R_{TRACE} is tested, R_1 should be selected using equation (12):

$$R_1 = \frac{R_{TRACE} \times R_X}{K_{SNS}} \quad (12)$$

R_X is 150k Ω , and K_{SNS} is 0.3. In practice, the R_{TRACE} ranges from 120m Ω to 200m Ω

R_2 is calculated using equation (13):

$$R_2 = \frac{V_{IN_REF_DCHG}}{V_{LOAD} - V_{IN_REF_DCHG}} \times R_1 \quad (13)$$

V_{LOAD} should be equal to the regulation voltage; $V_{IN_REF_DCHG}$ is 1.2V.

For example:

a. Given $R_{TRACE} = 200m\Omega$.

$$R_1 = \frac{R_{TRACE} \times R_X}{K_{SNS}} = \frac{0.2 \times 150k}{0.3} = 100k \quad (14)$$

For 5V regulation, $R_2 = 31.6k\Omega$

b. Given $R_{TRACE} = 120m\Omega$

$$R_1 = \frac{R_{TRACE} \times R_X}{K_{SNS}} = \frac{0.2 \times 150k}{0.3} = 60k \quad (15)$$

For 5V regulation, $R_2 = 18.9k\Omega$

Regardless the drop compensation value, a 300mV maximum compensation limit is designed. Given a 5V output application, the maximum regulation voltage at IN is 5.3V.

Battery Current Monitor

I_B represents the battery current. The current flowing out from I_B is proportional to the battery current. Connect an external resistor to convert the current signal to a voltage signal. See equation (16):

$$V_{IB} = I_B \times R_{IB} \quad (16)$$

I_B is specially designed for a low current level (80-120mV) with high accuracy. Table 5 shows the relationship between the battery current and the I_B voltage when connecting a 80k Ω resistor.

Use in boost mode for a light-load shutdown.

For example, the light-load shutdown current is lower than 80mA. V_{IB} is 80mV when the battery current is 80mA. Set the light-load shutdown threshold to 80mV, then the MP2639B can be turned off by monitoring when the V_{IB} voltage falls below 80mV.

Table 5: I_{BATT} (mA) vs. I_{IB} (μ A) in Discharge Mode

| I_{BATT} (mA) | I_{IB} (μ A) (-20% to +20%) | R_{IB} (k Ω) | V_{IB} (mV) |
|--------------------|---------------------------------------|---------------------------|------------------|
| 80 | 0.997 | 80 | 79.8 |
| 120 | 1.184 | 80 | 94.7 |

APPLICATION INFORMATION

Setting the Input Current Limit

The input current limit setting is set according to the input power source capability. The input current limit can be set through ILIM. Connect a resistor from ILIM to AGND to program the input current limit. The relationship is calculated using equation (17):

$$I_{IN_LIM} = \frac{640k}{3 \times R_{ILIM}(k)} (mA) \quad (17)$$

The tolerance is 12% of the input current limiting.

For a required minimum input current value, calculate its typical value first, then calculate the setting resistor based on equation 17. The max value can be calculated according to the tolerance. A 1% accuracy resistor is used for this setting.

For a given resistor of R_{ILIM} , the input current limit can be calculated (see Table 6).

Table 6: Example of R_{ILIM} setting

| Resistor | R_{ILIM} (k Ω) | I_{IN_LIM} (mA) | I_{IN_LIM} Tolerance (mA) | |
|----------|-----------------------------|-----------------------|---------------------------------|------|
| | | | -12% | +12% |
| Typ | 263.4 | 810 | 713 | 907 |
| Min | 260.8 | 818 | 720 | 916 |
| Max | 266 | 802 | 706 | 898 |

If a 263.4k Ω , 1% accuracy resistor for the input current limit setting is selected, the typical input current limit value is 810mA, the minimum input current limit value is 706mA, and the maximum input current limit value is 916mA.

Setting the Charge Current

The charge current of the MP2639B can be set by an external resistor (R_{ISET}) according to equation (18):

$$I_{CC} = \frac{640k}{3 \times R_{ISET}(k)} (mA) \quad (18)$$

For example, if the typical ICC is designed at 2A, then R_{ISET} is calculated as 106.7k Ω . The tolerance of the ICC setting is $\pm 10\%$. If the minimum or maximum charge current is required, first the typical value should be

calculated according to the tolerance. After that, calculate the resistor according to equation (18). A 1% accuracy resistor is used for this setting (see Table 7).

Table 7: Example of R_{ISET} setting

| Resistor | R_{ISET} (k Ω) | I_{CC} (mA) | I_{CC} Tolerance (mA) | |
|----------|-----------------------------|------------------|-------------------------|------|
| | | | -10% | +10% |
| Typ | 106.7 | 1999 | 1799 | 2199 |
| Min | 105.6 | 2020 | 1818 | 2222 |
| Max | 107.8 | 1979 | 1781 | 2177 |

If a customer selects a 106.7k Ω , 1% accuracy resistor for the constant charge current setting, then the typical input current limit value is 1999mA, the minimum input current limit value is 1781mA and the maximum input current limit value is 2222mA.

Setting the Input Voltage Regulation in Charge Mode

The input minimum limit voltage is set using a resistive voltage divider from the input voltage to V_{LIM} . The voltage divider divides the input voltage down to the limit voltage with the ratio in equation (19):

$$V_{IN_MIN_REF} = V_{IN_MIN} \times \frac{R_4}{R_3 + R_4} (V) \quad (19)$$

The input voltage can be calculated with equation (20):

$$V_{IN_MIN} = V_{IN_MIN_REF} \times \frac{R_3 + R_4}{R_4} (V) \quad (20)$$

The voltage clamp reference voltage ($V_{IN_MIN_REF}$) is 1.2V; R_4 is typically 10k Ω . With this value, calculate R_3 with equation (20).

For example, for a 4.65V input voltage limit, R_4 is 10k Ω , and R_3 is 28.75k Ω . The minimum value and the maximum value of the input voltage limit can be calculated according to the accuracy of the resistor and tolerance of $V_{IN_MIN_REF}$. A 1% accuracy resistor is used for R_3 and R_4 .

Setting the Output Current Limit in Discharge Mode

In discharge mode, connect a resistor from OLIM to AGND to program the output current limit. The

relationship between the output current limit and setting resistor is shown in equation (21):

$$I_{IN_DSCHG} = \frac{640k}{3 \times R_{OLIM}(k)} (mA) \quad (21)$$

The output current limit of the boost can be programmed up to 3A, and the tolerance is 10%.

For a required output current limit value, calculate its typical value first, then calculate the setting resistor using equation (21). The maximum value can be calculated according to the tolerance. A 1% accuracy resistor is used for this setting.

For a given resistor of R_{OLIM} , the output current limit of the boost can be calculated using Table 8.

Table 8: Example of R_{OLIM} setting

| Resistor | R_{OLIM} (k Ω) | I_{IN_DSCHG} (mA) | I_{IN_DSCHG} Tolerance (mA) | |
|----------|-----------------------------|-------------------------|-----------------------------------|------|
| | | | -10% | +10% |
| Typ | 71.1 | 3000 | 2700 | 3300 |
| Min | 70.4 | 3031 | 2728 | 3334 |
| Max | 71.8 | 2971 | 2674 | 3268 |

If a customer selects a 71.1k Ω , 1% accuracy resistor for the input current limit setting, then the typical input current limit value is 3000mA, the minimum input current limit value is 2674mA, and the maximum input current limit value is 3334mA.

Setting the Output Voltage in Discharge Mode

The MP2639B can regulate the output voltage on IN during discharge mode through the voltage divider according to equation (22):

$$V_{LOAD} = V_{IN_DSCHG_REF} \times \frac{R_1 + R_2}{R_2} \quad (22)$$

V_{LOAD} is the voltage user system required to power its load, $V_{IN_DSCHG_REF}$ is the reference of the output voltage loop, which is 1.2V.

The IC implements the internal line drop compensation by feeding the output current to the top feedback resistance R1.

The selection of R1 must meet the requirements of equation (23):

$$R_1 = \frac{R_{TRACE} \times R_X}{K_{SNS}} \quad (23)$$

R_X is 150k Ω , and $K_{SNS}=0.3$. R_{TRACE} is the line resistance of the trace from the output of the IC to the load of the system. According to different evaluations on the R_{TRACE} , choose an R1 value for correct compensation according to Table 9.

Table 9: Presume V_{LOAD} is required to regulate at 5V.

| R_{TRACE} (Ω) | R_1 (k Ω) | R_2 (k Ω) |
|--------------------------|---------------------|---------------------|
| 20m | 10 | 3.16 |
| 50m | 15 | 4.75 |
| 100m | 50 | 15.8 |
| 150m | 75 | 23.7 |
| 200m | 100 | 31.6 |

Note: there is a maximum compensation voltage limit on the R_{TRACE} , which means the compensated output voltage of the IC is a maximum 0.3V higher than the voltage on the load side.

When the output voltage is regulated to 9V, 12V or 15V, re-calculate the R1 and R2 according to Table 9.

Resistor Selection for the NTC Sensor

On page 20, Figure 6 shows an internal resistor divider reference circuit which includes four temperature thresholds, V_{COLD} , V_{COOL} , V_{WARM} and V_{HOT} .

For a given NTC thermistor, select an appropriate R_L and R_H to set the hot and cold temperature protection point according to equation (24) and equation (25):

$$\frac{\frac{R_L \times R_{NTC_COLD}}{R_L + R_{NTC_COLD}}}{R_H + \frac{R_L \times R_{NTC_COLD}}{R_L + R_{NTC_COLD}}} = V_{COLD} \quad (24)$$

$$\frac{\frac{R_L \times R_{NTC_HOT}}{R_L + R_{NTC_HOT}}}{R_H + \frac{R_L \times R_{NTC_HOT}}{R_L + R_{NTC_HOT}}} = V_{HOT} \quad (25)$$

R_{NTC_HOT} is the value of the NTC resistor at a high temperature, and R_{NTC_COLD} is the value of the NTC resistor at a low temperature.

The two resistors (R_H and R_L) allow the high and low temperature limits to be programmed independently.

For example, for a 103AT-2 thermistor, the thermistor has the following electrical characteristics:

Assume the cold temperature point is 0°C:

$$R_{NTC_COLD} = R_{0^{\circ}C} = 27.28k\Omega$$

Assume the high temperature point is 60°C:

$$R_{NTC_HOT} = R_{60^{\circ}C} = 3.02k\Omega$$

Using the resistor values above, we can get $R_H = 2.26k\Omega$, $R_L = 6.87k\Omega$. In this case, the warm and cool temperature protection point would be 10°C and 45°C.

For another design point, please contact an MPS FAE to get the NTC resistor selection spreadsheet.

Selecting the Inductor

Inductor selection requires a tradeoff between cost, size, and efficiency. A lower inductance value corresponds to a smaller size, but results in higher ripple currents, higher magnetic hysteretic losses, and higher output

capacitances. The inductor ripple current should not exceed 30% of the maximum load current under worst cases conditions. For example, if the I_{CHG} is 5A, then ΔI_L is generally set at 1.5A

However, for a light-load condition, the inductor ripple current is very small, which may cause unstable operation due to the peak current mode control of the IC. For stable operation, the minimum limit value for the inductor current ripple is 0.5A. Therefore, the inductor current ripple is 30% of the maximum value between I_{CHG} and 0.5A.

The inductance can be calculated according to Equation (26):

$$L = \frac{V_{IN} - V_{BATT}}{\Delta I_L} \frac{V_{BATT}}{V_{IN} \times F_{SW}} (\mu H) \quad (26)$$

The peak current of the inductor is calculated with equation (27)

$$I_{PEAK} = I_{LOAD(MAX)} + \Delta I_{LMAX} \quad (27)$$

Where V_{IN} , V_{BATT} , and F_{SW} are the input voltage, the battery voltage, and the switching frequency, respectively.

Table 10 provides the inductance selection guide for different input voltages.

Table 10: Inductance Selection Guide under Different Input Voltage

| SPEC | Inductance Selection | | | | | | | |
|------|----------------------|--|--------------------------|--------------------------|------------------|--|----------------------|-------------------------|
| | V_{IN} | $\Delta I_L = \max(0.3 \cdot I_{CHG}, 0.5A)$ $\Delta I_{LMIN} = 0.5A$ $\Delta I_{LMAX} = 1.5A$ | L_{MIN} (μH) | L_{MAX} (μH) | L (μH) | Saturation Current (A) ⁽⁶⁾ | DCR (m Ω) | Package |
| 5V | | | 0.67 | 2 | 1.2 | >6.25 | <50 | Application Required |
| 9V | | | 1.11 | 3 | 2.2 | >6.25 | <50 | Application Required |
| 12V | | | 1.25 | 3.75 | 2.2 | >6.25 | <50 | Application Required |

Note:

7) Saturation Current of the inductor should be higher than the I_{PEAK} , add 0.5A margin here.

If V_{IN} is higher or equal to 12V, the output power is over 10W.

Selecting the IN Capacitor(C_{IN})

The IN port is the input of the buck converter during charge mode, and the output of the boost converter during discharge mode. The capacitor (C_{IN}) at IN absorbs the ripple current from the PWM converter.

In charge mode, C_{IN} is the input capacitor of the buck converter. The input current ripple can be calculated with equation (28):

$$I_{RMS_MAX} = I_{CC_MAX} \times \frac{\sqrt{V_{BATT_PRE} \times (V_{IN_MAX} - V_{BATT_PRE})}}{V_{IN_MAX}} \quad (28)$$

In discharge mode, C_{IN} is the output capacitor of the boost converter. C_{IN} keeps the V_{IN} ripple small (<0.5%) and ensures feedback loop stability.

For $I_{CC_MAX} = 5A$, $V_{BATT_PRE} = 3V$, and $V_{IN_MAX} = 16V$, the maximum ripple current is 2.05A. Select the input capacitors, so that the temperature rise caused by the ripple current does not exceed 10°C. Ceramic capacitors with X5R or X7R dielectrics are recommended because of their low ESR and small temperature coefficients. Recommended capacitance is 44µF. A capacitor with a 25V rating or higher is preferred for a 16V input voltage.

The input decoupling capacitor should be placed as close as possible to IN and PGND.

Selecting the BATT Capacitor(C_{BATT})

Select the BATT capacitor (C_{BATT}) based on the demand of the system current ripple.

C_{BATT} is the output capacitor of the buck converter during charge mode and the input capacitor of the boost converter during discharge mode. Calculate its values with equation (30) and equation (31):

$$\Delta r_{VBATT} = \frac{\Delta V_{VBATT}}{V_{VBATT}} = \frac{1 - V_{VBATT} / V_{VIN}}{8 \times C_{VBATT} \times f_{SW}^2 \times L} \quad (30)$$

$$C_{VBATT} = \frac{1 - V_{VBATT} / V_{VIN_MAX}}{8 \times \Delta r_{VBATT_MAX} \times f_{SW}^2 \times L} \quad (31)$$

It is recommended that the capacitance is no lower than 25µF, and the 16V voltage rating capacitor is sufficient.

TYPICAL APPLICATION CIRCUITS

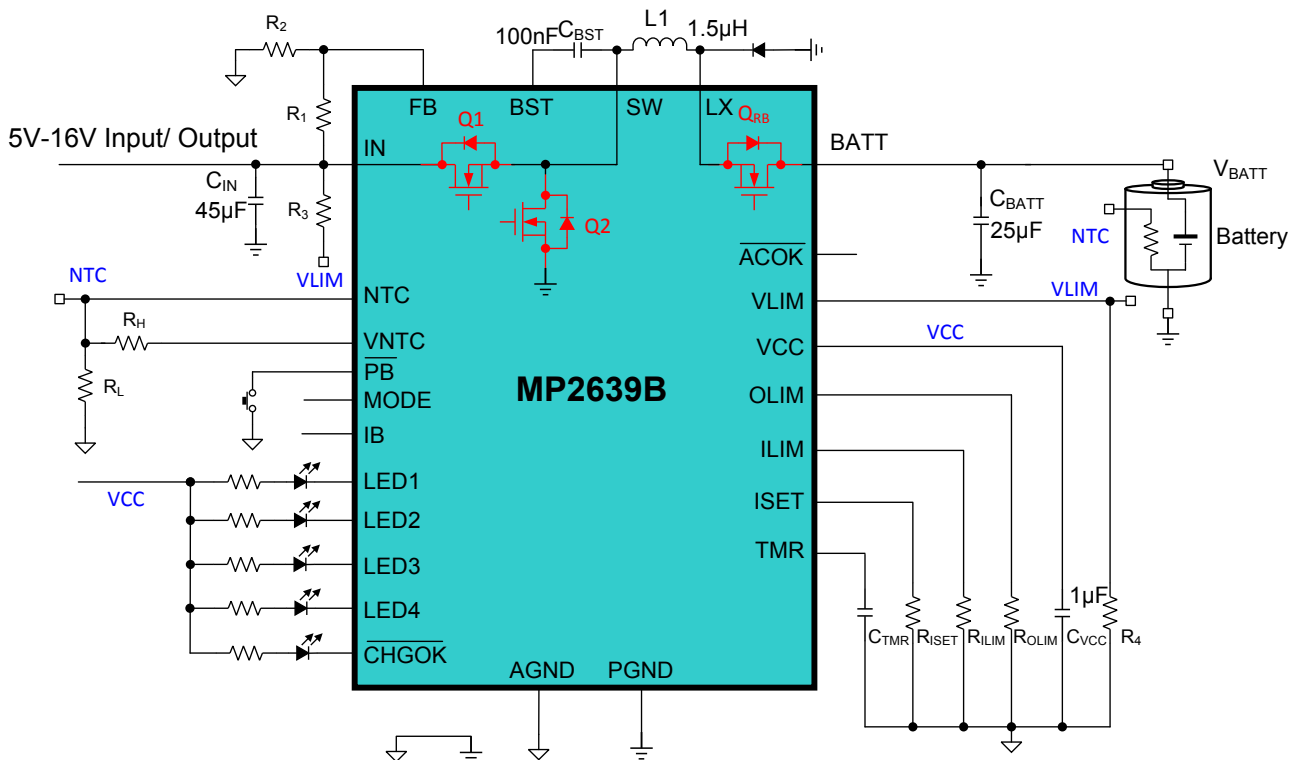

Figure 9 Typical Application Circuit

Table 11: Key BOM for Figure 9

| Qty | Ref | Value | Description | Package | Manufacture |
|-----|-------------------|-------------------|---|--------------|-------------|
| 3 | C _{IN} | 2x22µF 1x1µF | Ceramic capacitor;25V;X5R or X7R | 1206 0603 | Any |
| 3 | C _{BATT} | 2x10µF 1x4.7µF | Ceramic capacitor;16V;X5R or X7R | 1206 0805 | Any |
| 1 | C _{VCC} | 1µF | Ceramic capacitor;6.3V;X5R or X7R | 0603 | Any |
| 1 | C _{BST} | 100nF | Ceramic capacitor;25V;X5R or X7R | 0603 | Any |
| 1 | L1 | 1.5µH | Inductor; 1.5µH; Saturation current>10A;Low DCR | SMD | Any |

The MP2639B can be used together with external PD controller to achieve the PD power bank solution. Below is a simplified application circuit, for detailed schematic source file or EV Kit please contact FAE window.

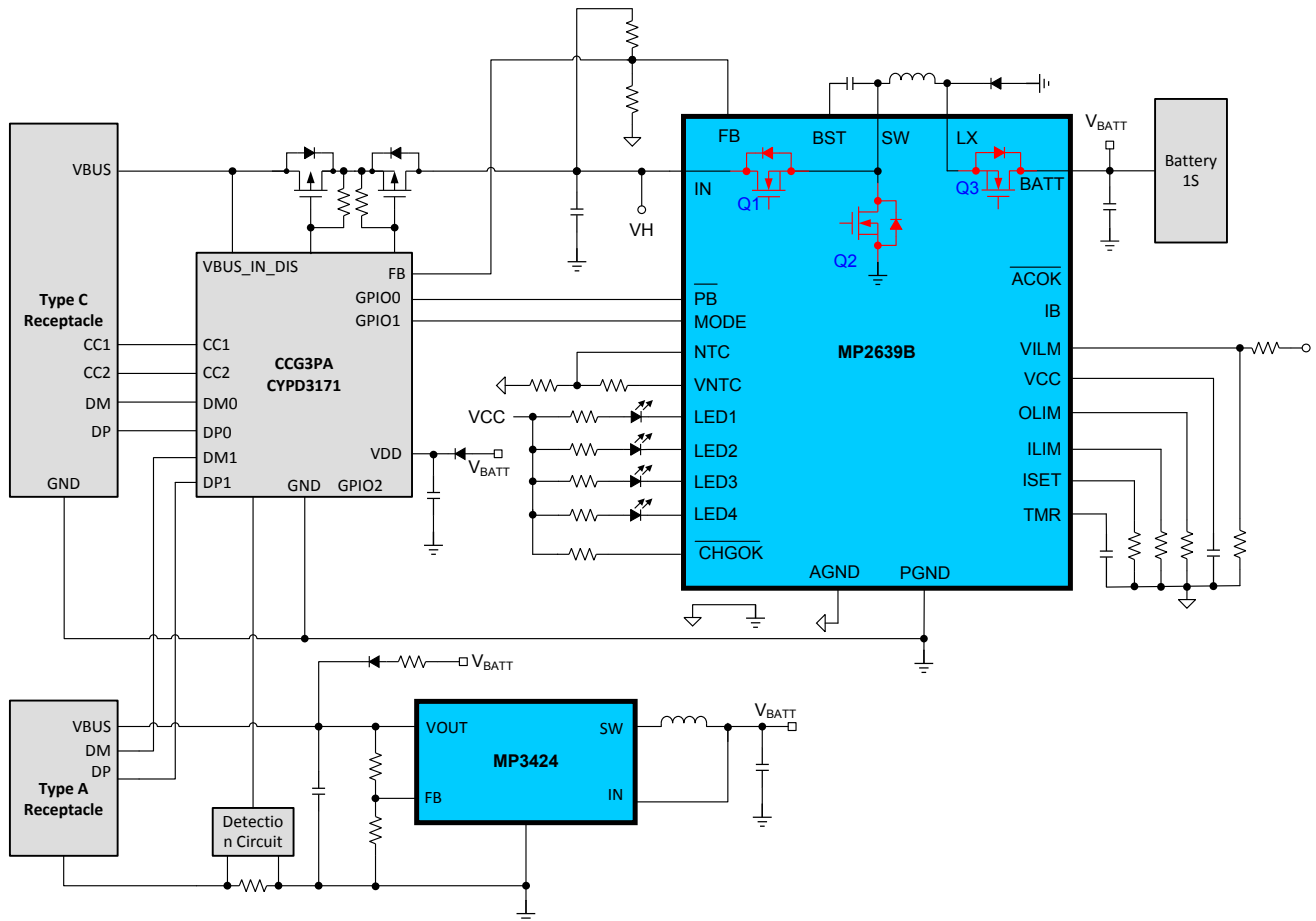
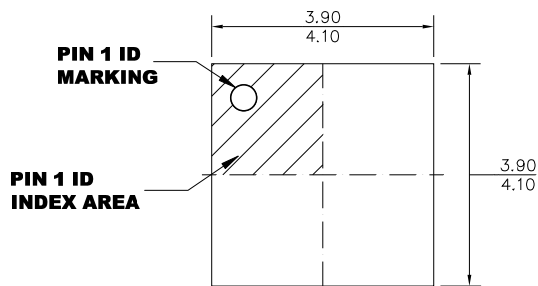

Figure 10: PD Power Bank Application

PACKAGE INFORMATION

QFN-26 (4mmx4mm)



TOP VIEW

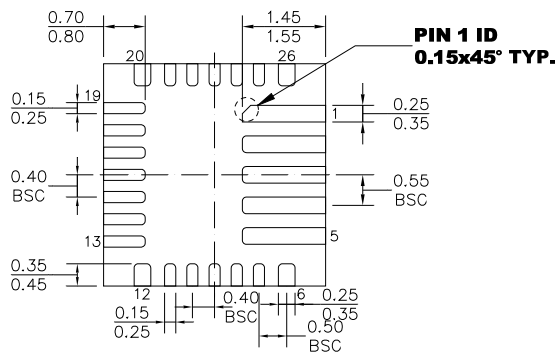

BOTTOM VIEW

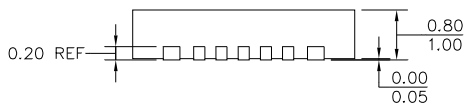

SIDE VIEW

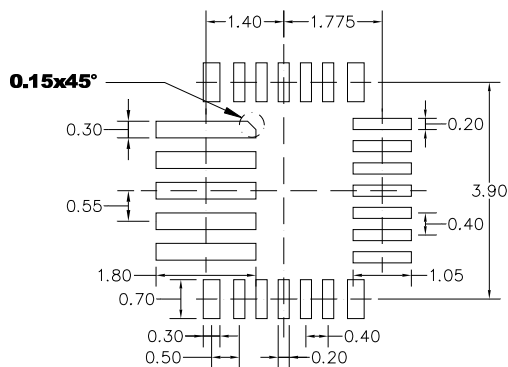

RECOMMENDED LAND PATTERN

NOTE:

- 1) ALL DIMENSIONS ARE IN MILLIMETERS.
- 2) LEAD COPLANARITY SHALL BE 0.10 MILLIMETERS MAX.
- 3) DRAWING CONFORMS TO JEDEC MO-220.
- 4) DRAWING IS NOT TO SCALE.

NOTICE: The information in this document is subject to change without notice. Please contact MPS for current specifications. Users should warrant and guarantee that third party Intellectual Property rights are not infringed upon when integrating MPS products into any application. MPS will not assume any legal responsibility for any said applications.